

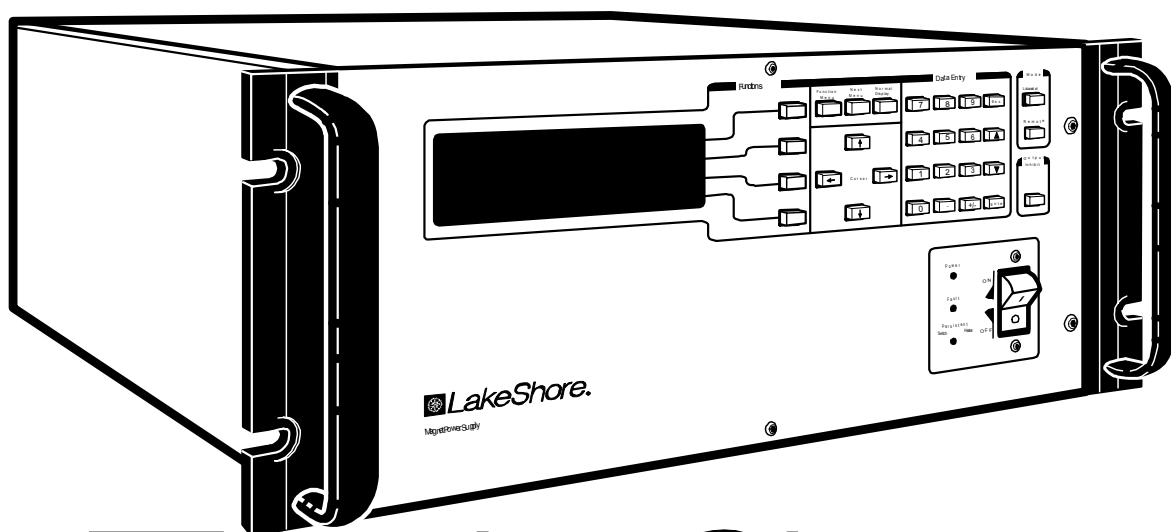

USER'S MANUAL

Model 647

Magnet Power Supply



 **LakeShore**®

Lake Shore Cryotronics, Inc. • 575 McCorkle Blvd. • Westerville, OH 43082-8888

PH: 614-891-2243 • FAX: 614-891-1392

Internet Addresses: sales@lakeshore.com, service@lakeshore.com

Methods and apparatus disclosed and described herein have been developed solely on company funds of Lake Shore Cryotronics, Inc. No government or other contractual support or relationship whatsoever has existed which in any way affects or mitigates proprietary rights of Lake Shore Cryotronics, Inc. in these developments. Methods and apparatus disclosed herein may be subject to U.S. Patents existing or applied for. Lake Shore Cryotronics, Inc. reserves the right to add, improve, modify, or withdraw functions, design modifications, or products at any time without notice. Lake Shore shall not be liable for errors contained herein or for incidental or consequential damages in connection with furnishing, performance, or use of this material.

MAGNET POWER SUPPLY CONFIGURATION

Sales Order Number: _____ MPS Model Number: _____

Shipping Date: _____ MPS Serial Number: _____

Power Settings: _____

Below is a checklist of major options installed in your Model 622/633 Magnet Power Supply. Read the manual before attempting to operate the equipment.

- 6224** IEEE-488/Serial Interface
- 6476** Gaussmeter Input Card
- 6477** High Resolution Display and Programming

Special Configurations:

LIMITED WARRANTY

Lake Shore Cryotronics, Inc. (henceforth Lake Shore), the manufacturer, warrants the instrument to be free from defects in material and workmanship for a period of twelve months from the date of shipment. During the warranty period, under authorized return of instruments or component parts to Lake Shore freight prepaid, the company will repair, or at its option replace, any part found to be defective in material or workmanship, without charge to the Owner for parts, service labor or associated customary shipping cost. Replacement or repaired parts will be warranted for only the unexpired portion of the original warranty.

All products are thoroughly tested and calibrated to published specifications prior to shipment. Calibration Certifications are offered for six month periods only. Where such documentation must be updated, a re-certification service is offered by Lake Shore at a reasonable cost.

LIMITATION OF WARRANTY: This warranty is limited to Lake Shore products purchased and installed in the United States, or Internationally through our approved distribution agents. This same protection will extend to any subsequent owner during the warranty period. It does not apply to damage resulting from improper or inadequate maintenance, unauthorized modification or misuse, operation outside of the environmental specifications, or from buyer-supplied software interfacing. It does not apply to damage caused by accident, misuse, fire, flood or Acts of God, or from failure to properly install, operate, or maintain the product in accordance with the printed instruction provided.

This warranty is in lieu of any other warranties, expressed or implied, including merchantability or fitness for a particular purpose, which are expressly excluded. The owner agrees that Lake Shore's liability with respect to this product shall be set forth in this warranty, and incidental or consequential damages are expressly excluded.

CERTIFICATION: Lake Shore certifies that this product has been inspected and tested in accordance with its published specifications and that this product met its published specifications at the time of shipment. The accuracy and calibration of this product at the time of shipment are traceable to the United States National Institute of Standards and Technology (NIST); formerly known as the National Bureau of Standards (NBS), or to a recognized natural standard.

TRADEMARK ACKNOWLEDGMENT: Many manufacturers and sellers claim designations as trademarks to distinguish their products. Where those designations appear in this manual and Lake Shore was aware of a trademark claim, they appear with initial capital letters and a proceeding TM or [®] symbol.

CalCurveTM, Carbon-GlassTM, CernoxTM, Duo-TwistTM, IDEATM, Gamma ProbeTM, Quad-LeadTM, and Quad-TwistTM are trademarks of Lake Shore Cryotronics, Inc.

Kapton[®] is a trademark of 3M.

Stycast[®] is a trademark of Emerson & Cuming.

Teflon[®] is a trademark of DuPont De Nemours.

QuickBasic[®] is a trademark of Microsoft Corporation.

TABLE OF CONTENTS

| <i>Chapter/Paragraph</i> | <i>Title</i> | <i>Page</i> |
|--------------------------|---|-------------|
| | List of Illustrations | iv |
| | List of Tables | iv |
| | Foreword | v |
| | Purpose and Scope | v |
| | Hardware Covered | v |
| | How To Use This Manual | v |
| | Warnings, Cautions, and Notes | v |
| | General Installation Precautions | v |
| | Electrostatic Discharge | vi |
| | Handling Electrostatic Discharge Sensitive Components | vi |
| | Safe Handling of Liquid Cryogenics | vi |
| | Magnet Quenches | vii |
| | Dangerous Voltages | vii |
| | Before You Operate the Equipment | vii |
| | Safety Summary | viii |
| | Safety Symbols | viii |
| 1 | INTRODUCTION | 1-1 |
| 1.0 | General | 1-1 |
| 1.1 | 647 Magnet Power Supply Features | 1-1 |
| 1.2 | Specifications | 1-2 |
| 1.3 | Operating Characteristics | 1-4 |
| 1.3.1 | True, Four-Quadrant Bidirectional Power Flow | 1-4 |
| 1.3.2 | Low Noise, High Stability Current Regulated Output | 1-5 |
| 1.3.3 | Highly Efficient, Air-Cooled, Compact Unit | 1-5 |
| 2 | INITIAL SETUP AND CONNECTIONS | 2-1 |
| 2.1 | Inspecting and Unpacking | 2-1 |
| 2.2 | MPS Mounting | 2-1 |
| 2.3 | Environmental Requirements | 2-1 |
| 2.4 | Connecting the MPS to Power | 2-2 |
| 2.4.1 | Power and Ground Requirements | 2-2 |
| 2.4.2 | MPS Input Power Ratings | 2-2 |
| 2.4.3 | Input Power Connections | 2-2 |
| 2.5 | Power Up | 2-3 |
| 2.5.1 | Magnet Cable Connections | 2-3 |
| 2.5.2 | Shielding, Grounding, and Noise | 2-4 |
| 2.5.3 | MPS Remote Inhibit and Fault Indicator Connections | 2-4 |
| 2.5.4 | AC On Indicator | 2-4 |
| 2.5.5 | OVP Connection | 2-4 |
| 2.5.6 | MPS Analog Current and Voltage Monitoring Connections | 2-5 |
| 2.5.7 | External Current Programming | 2-5 |
| 2.5.8 | Remote Sense Connections | 2-6 |
| 2.6 | Multiple Auto-Parallel Setup | 2-6 |
| 2.7 | Post-Installation Instructions | 2-9 |
| 2.8 | System Shutdown and Repackaging for Storage or Shipment | 2-9 |
| 2.9 | Returning Equipment to Lake Shore | 2-9 |

| <i>Chapter/Paragraph</i> | <i>Title</i> | <i>Page</i> |
|--------------------------|--|-------------|
| 3 | OPERATION | 3-1 |
| 3.0 | General | 3-1 |
| 3.1 | The MPS Front Panel | 3-1 |
| 3.2 | Power UP | 3-1 |
| 3.3 | General Display Description | 3-2 |
| 3.4 | Numeric Entry | 3-2 |
| 3.5 | Function Menu 1 | 3-2 |
| 3.5.1 | Setup Screen | 3-2 |
| 3.5.2 | Output Only Screen | 3-3 |
| 3.5.3 | Display Plot Screen | 3-3 |
| 3.5.4 | Ramp Status Screen | 3-3 |
| 3.6 | Function Menu 2 | 3-3 |
| 3.7 | Function Menu 3 | 3-4 |
| 3.7.1 | Current Zero Screen | 3-4 |
| 3.7.2 | Current Step Limit Screen | 3-4 |
| 4 | REMOTE OPERATION | 4-1 |
| 4.0 | General | 4-1 |
| 4.1 | IEEE-488 Interface | 4-1 |
| 4.1.1 | IEEE-488 Interface Settings | 4-1 |
| 4.1.2 | IEEE-488 Command Structure | 4-2 |
| 4.1.2.1 | Bus Control Commands | 4-2 |
| 4.1.2.2 | Common Commands | 4-2 |
| 4.1.2.3 | Interface and Device Specific Commands | 4-2 |
| 4.1.3 | Status Registers | 4-2 |
| 4.1.3.1 | Status Byte and Service Request Enable Registers | 4-3 |
| 4.1.3.2 | Standard Event and Standard Event Status Registers | 4-4 |
| 4.1.4 | Example IEEE Setup and Program | 4-4 |
| 4.1.4.1 | GPIB Board Installation | 4-4 |
| 4.1.4.2 | Run the Example QuickBasic Program | 4-5 |
| 4.1.5 | Notes On Using the IEEE Interface | 4-5 |
| 4.2 | Serial I/O Interface | 4-8 |
| 4.2.1 | Serial Interface Hardware Configuration | 4-9 |
| 4.2.2 | Serial Interface Settings | 4-9 |
| 4.2.3 | Sample BASIC Serial Interface Program | 4-9 |
| 4.2.4 | Notes on Using the Serial Interface | 4-9 |
| 4.3 | Summary of IEEE-488/Serial Interface Commands | 4-11 |
| 4.3.1 | Commands Description List Structure | 4-11 |
| 4.3.1.1 | Operational Commands Description | 4-12 |
| 4.3.1.2 | Interface Commands Description | 4-14 |
| 4.3.1.3 | Ramping Commands Description | 4-15 |
| 4.3.1.4 | Current Zero Commands Description | 4-16 |
| 4.3.1.5 | Current Step Limit Commands Description | 4-17 |
| 4.3.1.6 | Common Commands Description | 4-18 |
| 5 | ERROR MESSAGES AND TROUBLESHOOTING | 5-1 |
| 5.0 | General | 5-1 |
| 5.1 | Software Error Messages | 5-1 |
| 5.2 | Factory Default Settings | 5-3 |
| 5.3 | Calibration | 5-4 |
| 5.4 | Performance Test | 5-5 |
| 5.5 | Rear Panel Connector Details | 5-6 |
| 5.6 | IEEE-488 Interface Connector (If Present) | 5-7 |
| 5.7 | Serial Interface Cable and Adapters | 5-7 |

| <i>Chapter/Paragraph</i> | <i>Title</i> | <i>Page</i> |
|---|---|-------------|
| 6 | OPTIONS AND ACCESSORIES | 6-1 |
| 6.0 | General..... | 6-1 |
| 6.1 | Model 6224 IEEE-488/Serial Interface..... | 6-1 |
| 6.2 | Model 6476 Gaussmeter Input Card..... | 6-1 |
| 6.2.1 | Hall Sensor Mounting Considerations | 6-1 |
| 6.2.2 | Connections | 6-2 |
| 6.2.3 | Installation | 6-2 |
| 6.2.4 | Operation..... | 6-3 |
| 6.2.5 | Remote Operation Commands | 6-3 |
| 6.3 | Model 6477 High Resolution Display and Programming Option | 6-4 |
| 6.4 | Accessories..... | 6-5 |
| APPENDIX A – UNITS FOR MAGNETIC PROPERTIES | | A-1 |
| APPENDIX B – MAINFRAME REMOTE OPERATION | | B-1 |
| B1.0 | General..... | B-1 |
| B2.0 | Control Bus Serial Interface Specifications..... | B-1 |
| B3.0 | Control Bus Serial Interface Connector | B-1 |
| B4.0 | Control Bus Serial Interface Configuration | B-2 |
| B5.0 | Selecting the Control Bus Serial Interface Address..... | B-2 |
| B6.0 | Control Bus Serial Interface Operation | B-3 |
| B7.0 | Control Bus Serial Interface Sample Program..... | B-4 |

LIST OF ILLUSTRATIONS

| Figure No. | Title | Page |
|-------------------|---|-------------|
| 1-1 | Four-Quadrant Power | 1-4 |
| 1-2 | Comparison of Old and New MPS Designs | 1-5 |
| 2-2 | RI, FLT, ON, and OVP Connections | 2-4 |
| 2-3 | Analog Monitoring, Programming, & Remote Sense Connections | 2-5 |
| 2-4 | Remote Sensing Connections | 2-6 |
| 2-5 | Typical Multiple MPS Connections for Two MPS Units | 2-8 |
| 3-1 | Front Panel Numeric Entry Keys | 3-1 |
| 4-1 | Typical National Instruments GPIB Configuration from IBCONF.EXE | 4-7 |
| 4-2 | Serial Interface Adapters | 4-8 |
| 5-1 | Rear Panel Connectors | 5-6 |
| 5-2 | Serial Interface Connector | 5-6 |
| 5-3 | IEEE-488 Connector | 5-7 |
| 5-4 | Model 2001 RJ-11 Cable Assembly Wiring | 5-7 |
| 5-5 | Model 2002 RJ-11 to DB-9 Adapter Wiring | 5-7 |
| 5-6 | Model 2003 RJ-11 to DB-25 Adapter Wiring | 5-7 |

LIST OF TABLES

| Table No. | Title | Page |
|------------------|--|-------------|
| 1-1 | Model 647 DC Output Specifications | 1-3 |
| 2-1 | MPS Line Voltage Limits | 2-2 |
| 2-2 | Load Wire Lengths and Current Capacity | 2-3 |
| 2-3 | RI, FLT, ON, and OVP Connections | 2-4 |
| 2-4 | Analog Monitoring, Programming, and Remote Sense Connections | 2-5 |
| 2-5 | Connections for a Two-MPS Autoparallel Configuration | 2-8 |
| 4-1 | Sample Basic IEEE-488 Interface Program | 4-6 |
| 4-2 | Serial Interface Specifications | 4-9 |
| 4-3 | Sample Basic Serial Interface Program | 4-10 |
| 5-1 | Rear Panel Connector Definitions | 5-6 |
| 5-2 | Serial Interface Connector Definition | 5-6 |
| 5-3 | IEEE-488 Interface Connector Definition | 5-7 |
| A-1 | Units for Magnetic Properties | A-1 |
| B-1 | MPS Mainframe Control Bus Remote Command Summary | B-5 |
| B-2 | Additional MPS Mainframe Control Bus Remote Commands | B-6 |

FOREWORD

PURPOSE AND SCOPE

This manual contains user instructions for the Model 647 Superconducting Magnet Power Supply. Lake Shore Cryotronics, Inc. designed, manufactures, and assembles the MPS in the United States of America.

We welcome your comments concerning this manual. Although every effort has been made to keep it free of errors, some may occur. To report a specific problem, please describe it briefly and include the manual title and revision number, the paragraph/figure/table number, and the page number. Send comments to Lake Shore Cryotronics, Inc. Attn: Technical Publications, 575 McCorkle Blvd., Westerville, Ohio 43082-8888.

HARDWARE COVERED

The MPS is available in the following configuration:

Model 647 Electromagnet Power Supply: ± 72 A, ± 32 V, 2 kVA

Page A of this manual (following the title page) details the options installed in your unit. See chapter 6 for detailed definitions of hardware configurations.

WARNINGS, CAUTIONS, AND NOTES

Warnings, cautions, and notes appear throughout this manual and always precede the step to which they pertain. Multiple warnings, cautions, or notes are bulleted.

WARNING: An operation or maintenance procedure which, if not strictly observed, may result in injury, death, or long-term health hazards to personnel.

CAUTION: An operation or maintenance procedure which, if not strictly observed, may result in equipment damage, destruction, or loss of effectiveness.

NOTE: Emphasizes an operation or maintenance procedure.

GENERAL INSTALLATION PRECAUTIONS

These recommended general safety precautions are unrelated to any specific procedure and do not appear elsewhere in this manual. Personnel should understand and apply these precautions during installation.

Installation personnel shall observe all safety regulations at all times. Keep away from live circuits. Turn off system power before making or breaking electrical connections. Regard any exposed connector, terminal board, or circuit board as a possible shock hazard. Discharge charged components only when such grounding cannot damage equipment. If a test connection to energized equipment is required, make the test equipment ground connection before probing the voltage or signal.

Do not install or service equipment alone. Do not under any circumstances reach into or enter any enclosure to service or adjust equipment without the presence or assistance of another person able to render aid.

ELECTROSTATIC DISCHARGE

Electrostatic Discharge (ESD) may damage electronic parts, assemblies, and equipment. ESD is a transfer of electrostatic charge between bodies at different electrostatic potentials caused by direct contact or induced by an electrostatic field. The low-energy source that most commonly destroys Electrostatic Discharge Sensitive (ESDS) devices is the human body, which generates and retains static electricity. Simply walking across a carpet in low humidity may generate up to 35,000 volts of static electricity.

Current technology trends toward greater complexity, increased packaging density, and thinner dielectrics between active elements, which results in electronic devices with even more ESD sensitivity. Some electronic parts are more ESDS than others. ESD levels of only a few hundred volts may damage electronic components such as semiconductors, thick and thin film resistors, and piezoelectric crystals during testing, handling, repair, or assembly. Discharge voltages below 4000 volts cannot be seen, felt, or heard.

Identification of Electrostatic Discharge Sensitive Components

Below are various industry symbols used to label components as ESDS:



HANDLING ELECTROSTATIC DISCHARGE SENSITIVE COMPONENTS

Observe all precautions necessary to prevent damage to ESDS components before attempting installation. Bring the device and everything that contacts it to ground potential by providing a conductive surface and discharge paths. As a minimum, observe these precautions:

1. De-energize or disconnect all power and signal sources and loads used with unit.
2. Place unit on a grounded conductive work surface.
3. Ground technician through a conductive wrist strap (or other device) using 1 MΩ series resistor to protect operator.
4. Ground any tools, such as soldering equipment, that will contact unit. Contact with operator's hands provides a sufficient ground for tools that are otherwise electrically isolated.
5. Place ESDS devices and assemblies removed from a unit on a conductive work surface or in a conductive container. An operator inserting or removing a device or assembly from a container must maintain contact with a conductive portion of the container. Use only plastic bags approved for storage of ESD material.
6. Do not handle ESDS devices unnecessarily or remove them from their packages until actually used or tested.

SAFE HANDLING OF LIQUID CRYOGENS

Two essential safety aspects of handling LHe are adequate ventilation and eye and skin protection. Although helium gas is non-toxic, it is dangerous because it replaces air in a normal breathing atmosphere. Liquid helium is an even greater threat because a small amount of liquid evaporates to create a large amount of gas. Store and operate cryogenic dewars in open, well-ventilated areas.

WARNING

- **Liquid helium is a potential asphyxiant and can cause rapid suffocation without warning. Store and use in an adequately ventilated area. DO NOT vent the container in confined spaces. DO NOT enter confined spaces where gas may be present unless area is well-ventilated. If inhaled, remove to fresh air. If not breathing, give artificial respiration. If breathing is difficult, give oxygen. Get medical attention.**
- **Liquid helium can cause severe frostbite to exposed body parts. DO NOT touch frosted pipes or valves. For frostbite, consult a physician immediately. If a physician is unavailable, warm the affected parts with water that is near body temperature.**

MAGNET QUENCHES

For protection during a magnet quench, fit the dewar with pressure relief valves of sufficient size and pressure rating to allow the helium gas to escape and to prevent excessive pressure in the dewar. Operating a magnet in a dewar without proper pressure relief is dangerous and possibly life-threatening. The magnet may transfer tremendous energy to the cryogen during a quench. Consult both the magnet and dewar manufacturers to check pressure relief valve sufficiency.

DANGEROUS VOLTAGES

High voltages are present inside the MPS. Never attempt to service the MPS. Refer all service to qualified personnel. There are no user-serviceable parts inside the MPS.

The MPS current output terminals may be dangerous. Although MPS output voltage is limited to ± 40 VDC, a catastrophic failure inside the MPS could pass lethal voltages to the output terminals. Do not touch the terminals during MPS operation.

BEFORE YOU OPERATE THE EQUIPMENT

Train personnel in proper emergency measures such as electrical power shut off, fire department notification, fire extinguishing, and personnel and records evacuation. Here is a list of suggested personnel safety considerations:

- Ground Fault Interrupter (GFI) AC circuits
- Fire Extinguisher
- Magnetic Field Warnings
- Emergency Lighting

Locate in the immediate vicinity fire extinguisher(s) that extinguish all three classes of fires: A, B, and C. Class A is ordinary combustibles like wood, paper, rubber, many plastics, and other common materials that burn easily. Class B is flammable liquids like gasoline, oil, and grease. Class C is energized electrical equipment including wiring fuse boxes, circuit breakers, machinery, and appliances. Do not use chemical extinguishers even though they are less expensive and cover all classes of fires. They may damage electronic equipment. Use a Carbon Dioxide or Halon fire extinguisher.

During the planning stage, consult local experts, building authorities, and insurance underwriters on locating and installing sprinkler heads, fire and smoke sensing devices, and other fire extinguishing equipment.

Even where not required by code, install some type of automatic, battery-operated emergency lighting in case of power failure or fire.

SAFETY SUMMARY

Observe the following general safety precautions during all phases of operation, service, and repair of this instrument. Failure to comply with these precautions or with specific warnings elsewhere in this manual violates safety standards of design, manufacture, and intended use of the instrument. Lake Shore Cryotronics, Inc. assumes no liability for the customer's failure to comply with these requirements.

Ground the Instrument

To minimize shock hazard, connect the instrument chassis and cabinet to an electrical ground. The instrument is equipped with a three-conductor AC power cable. Plug this cable into either an approved three-contact electrical outlet or a three-contact adapter with the grounding wire (green) firmly connected to an electrical ground (safety ground) at the power outlet. The power jack and mating plug of the power cable meet Underwriters Laboratories (UL) and International Electrotechnical Commission (IEC) safety standards.

Do Not Operate in an Explosive Atmosphere

Do not operate the instrument in the presence of flammable gases or fumes. Operating any electrical instrument in such an environment constitutes a definite safety hazard.

Keep Away from Live Circuits

Operating personnel must not remove instrument covers. Refer component replacement and internal adjustments to qualified maintenance personnel. Do not replace components with power cable connected. To avoid injuries, always disconnect power and discharge circuits before touching them.

Do Not Substitute Parts or Modify Instrument

Do not install substitute parts or perform any unauthorized modification to the instrument. Return the instrument to an authorized Lake Shore Cryotronics, Inc. representative for service and repair to ensure that safety features are maintained.

Dangerous Procedure Warnings

A WARNING heading precedes potentially dangerous procedures throughout this manual. Instructions in the warnings *must* be followed.

SAFETY SYMBOLS



Warns to protect the instrument against damage.



Indicates dangerous voltage (appears on terminals fed by voltage exceeding 1000 volts).

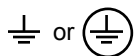

Protective conductor terminal. For protection against electrical shock in case of a fault. Used with field wiring terminals to indicate the terminal to connect to ground before operating equipment.



Low-noise or noiseless, clean ground (earth) terminal. Provides a signal common as well as protection against electrical shock in case of a fault. Connect a terminal marked with this symbol to ground as described in the user manual before operating equipment.

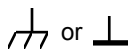

Frame or chassis terminal. A connection to the frame (chassis) of the equipment which normally includes all exposed metal structures.



Alternating current (power line).



Direct current (power line).



Alternating or direct current (power line).

CHAPTER 1

INTRODUCTION

1.0 GENERAL

This chapter covers Features (Paragraph 1.1), Specifications (Paragraph 1.2), and Operating Characteristics (Paragraph 1.3).

1.1 647 MAGNET POWER SUPPLY FEATURES

- **True, Four-Quadrant Bidirectional Power Flow**
Operate current or voltage as a source or a sink in either positive or negative polarities. Sink power returns to the AC line instead of dissipating through an energy absorber.
- **Low Noise, High Stability Current Regulation**
Analog output control uses a precision shunt for current stabilization to better than 50 PPM of full-scale current over an 8-hour period.
- **± 72 A, ± 32 V Output that is Autoranging at up to 2 kVA continuous**
Standard display and programming resolution is 10 mA and 10 mV. 1 mA and 1 mV High Resolution Option is available.
- **No current reversal switch is required**
Output current reversal is smooth and continuous with excellent near zero current performance.
- **Remote and local sensing of the output voltage**
Compensates for voltage drops in the output leads.
- **Quiet switched-mode design**
Results in a highly efficient, lightweight, air-cooled unit.
- **Front Panel Graphic Display**
Allows continuous display of output while setting parameters from the menu-driven keypad. Operating parameters that can be set and monitored are:
 1. Output current and voltage setting
 2. Output current and voltage measurement
 3. Output current step limiting
 4. Output current zeroing
 5. "Soft" current and voltage setting limits
 6. Output ramp programming
 7. Status reporting
 8. Field monitoring (with optional Model 6476 Card)
- **Four methods of setting and monitoring all operating parameters:**
 1. From front panel
 2. From remote interfaces
 3. Through analog inputs and outputs
- **IEEE-488 Interface available.**
- **Gaussmeter Input Option available.**
- **Protection**
Overvoltage/Quench protection circuits protect against internal overtemperature, AC line fault, and unit fault. Also includes a Remote Inhibit (RI) and a discrete Fault Indicator (FLT).

1.2 SPECIFICATIONS

Below are performance specifications for current with a 1 Henry load and voltage with a resistive load.

DC Output: True, Four-Quadrant, Bidirectional Power Flow output. Autoranging current and voltage operate as a source or a sink in either polarity in current or voltage mode. Program current and voltage via the front panel, remote interfaces, or analog input. See Table 1-1 for DC Output Specifications.

Current: 0 to ± 72 A Voltage: 0 to ± 32 V Maximum Power: 2 kVA continuous

Remote Sensing: Corrects for load lead drop of up to 0.5 V per lead. Operation with more drop per load lead is possible with a degradation of the load effect specification.

Output Terminals: The two rear panel output bus bars are isolated from the chassis (earth) ground.

Multiple Unit Operation: Connect up to four units in an auto-parallel configuration for increased output current.

Protection: Front panel annunciators, an audio indicator, and a contact closure indicate faults.

Remote Inhibit (RI): An active RI forces output settings to 0 A and 1 V until the RI is no longer active. To continue normal operation, enter new output settings.

Output Inhibit (OI): Press the front panel OI key to force output settings to 0 A and 1 V. To continue normal operation, enter new output settings.

Output Current Step Limit: The output current settings are forced to 0 A and 1 V if a preset current step limit is exceeded. A key entry is required to continue operation.

Utility Low Line or Loss: Maintains operation until load is discharged or utility is restored.

Utility High Line: Turns off input and maintains operation until load is discharged.

Overvoltage: Crowbars output when output terminal voltage, induced by the load exceeds ± 40 VDC.

Overtemperature: Crowbars output and turns off input when internal heat sink temperature exceeds 95 °C.

AC Input: Factory set for operation from 200, 208, 220, or 240 VAC (-10% , $+5\%$), 50 to 60 Hz, single phase.

Input Protection: A front panel 20 A two-pole circuit breaker protects the AC input. The MPS turns off the breaker in the event of a fault.

Remote Interfaces: RS-232C is standard; IEEE-488 is optional. All front panel functions can be controlled over the interfaces. In addition, interfaces output displayed quantities.

Input Current:

| Nominal Line Voltage (VAC) | Line Voltage Range (VAC) | Maximum Input Current (A rms) |
|----------------------------|--------------------------|-------------------------------|
| 200 | 180 to 210 | 16 |
| 208 | 188 to 218 | 15 |
| 220 | 198 to 231 | 14 |
| 240 | 216 to 250 | 13 |

Front Panel: Contains a menu driven keyboard and graphic display for entry and display of results. Operating parameters to set and monitor from the front panel (and remote interface) include:

- Output current and voltage setting
- Output current and voltage measurement
- Status reporting
- Output ramp programming
- "Soft" current and voltage setting limits
- Field Monitoring (with optional Model 6476 Card)
- Output Current Zeroing
- Output Current Step Limiting

Magnet inductance and maximum charging voltage ($di/dt = V/L$) limit the output ramp programming charging current. Program output for a constant 0.01 to 99.99 amperes per second as long as di_{max}/dt is not exceeded. Energize or de-energize the magnet at a pre-set voltage limit or ramp rate. Pause the ramp at any time during the ramp. During a pause, the MPS maintains output values until the ramp continues.

Agency Approvals: The Model 647 complies with the following requirements:

- UL 1244** - Electrical and Electronic Measuring and Testing Equipment
- VDE 0411** - Electronic Measuring Instruments and Automatic Controls
- FCC 15J** - Level A RFI Suppression
- VDE 0871** - Level A RFI Suppression

Operating Ambient Temperature: 15 to 35 °C (59 to 95 °F)

Dimensions: 483 mm wide x 178 mm high x 508 mm deep (19 x 7 x 20 inches)

Weight: 36.4 kilograms (80 pounds). Rack mounting is standard.

Table 1-1 Model 647 DC Output Specifications

| SPECIFICATION | CURRENT | VOLTAGE |
|---|--------------------------|-------------------------|
| Digital Programming Resolution: Standard/High | 10 mA / 1 mA | 10 mV / 1 mV |
| Digital Programming Accuracy | 0.1% I _{MAX} | 1% V _{MAX} |
| Digital Programming Repeatability | 0.01% I _{MAX} | 0.1% V _{MAX} |
| Electronic Resolution: Standard/High | 4 mA / 1 mA | 1 mV / 1 mV |
| Electronic Accuracy | 0.1% I _{MAX} | 0.1% V _{MAX} |
| Display Resolution: Standard/High | 10 mA / 1 mA | 10 mV / 1 mV |
| Stability (Drift) at 25 ±1 °C: Percent of full scale output change over 8-hours under constant line and load after a 30 minute warm-up. | ±0.005% I _{MAX} | ±0.01% V _{MAX} |
| Ripple and Noise: 10 Hz to 10 MHz at 1000 VA | 40 µA rms | 20 mV rms |
| Temperature Coefficient: Change in output per °C after 30 minute warm-up. | 0.1% I _{MAX} | 0.1% V _{MAX} |
| Source Effect: Line regulation for any line change within the rated line voltage. | 0.005% I _{MAX} | 0.05% V _{MAX} |
| Load Effect: Load regulation for a load change equal to maximum voltage in Constant Current Mode or maximum current in Constant Voltage Mode. | 0.1% I _{MAX} | 0.1% V _{MAX} |
| Analog Resistance Programming Accuracy: 0 to 10 KΩ produces negative full scale to positive full scale current or voltage output. 5 KΩ is 0 current. | 10% I _{MAX} | 10% V _{MAX} |
| Analog Voltage Programming Accuracy: Voltage input is ±0.01 V/A, ±0.01 V/V. | 1% + 100 mA | 2% + 100 mV |
| Monitoring Output Accuracy: Voltage output is ±0.01 V/A, ±0.01 V/V. | 1% + 100 mA | 2% + 100 mV |

1.3 OPERATING CHARACTERISTICS

Many Model 647 MPS operating characteristics ideally suit it for charge and discharge cycling of superconducting magnet loads. These characteristics significantly differentiate the Model 647 from conventional MPS's. Consider them when choosing the best MPS for a particular application.

1.3.1 True, Four-Quadrant Bi-directional Power Flow

Model 647 MPS: Sets either positive or negative current and voltage values. This true, four-quadrant operation significantly simplifies test procedures and system design by eliminating external switching or operator intervention to reverse current polarity. The smooth, continuous transition through zero current allows the user to readily analyze samples at very small current increments (as small as 1 mA) about zero. Power flow is bi-directional. Sink power (energy stored in the magnet) returns to the AC line instead of dissipating in an energy absorber. The MPS either transfers power from the AC line to the magnet, or from the magnet back to the AC line. The MPS also tolerates AC line faults; in the event of utility power failure, it draws power from the charged load to maintain operation until utility restoration.

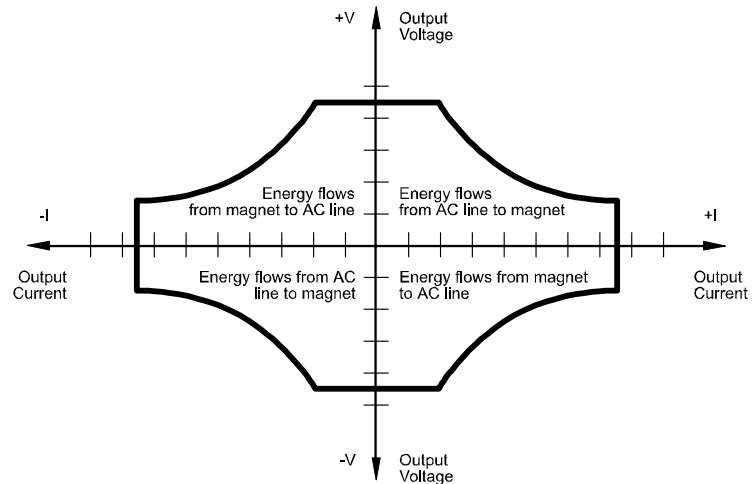

Figure 1-1 Four-Quadrant Power

Other conventional MPS's: Consist of a unipolar power supply with an energy absorber to dissipate magnet energy during discharge. The energy absorber prevents reverse voltage generated during the discharge from damaging the unipolar supply output. Other conventional supplies dissipate magnet energy in the power supply output transistor pass-bank. This two-quadrant performance requires the output stage to absorb considerable power during the discharge. In addition, uniform charge and discharge rates are not always ensured.

Current reversal requires external current reversal switches or manual lead reversal. These units provide pseudo-four-quadrant operation which introduces discontinuities at the current reversal point produced by switching the leads. Current reversal switches may incorporate direction detection diodes which reduce available magnet charging voltage and dissipate additional power. Current reversal switches must also interlock to prevent lead reversal when current is present. Current reversal switches complicate high power cabling requirements, increase chances of introducing output current instabilities, and require time to reverse leads. Manual lead reversal introduces discontinuity at the current reversal point. A discontinuous transition through zero current may require a small external supply for near zero current analysis. Utility power failure in a conventional supply generally results in a magnet quench.

1.3.2 Low Noise, High Stability Current Regulated Output

Model 647 MPS: Maintains a high-stability low-noise current-regulated output. Digital setting and monitoring electronics, and computer interfacing integrate into power management and precision analog control circuitry. This integration maintains high output stability and repeatability. Extensive output filtering and noise cancellation circuitry keep MPS output noise very low. The MPS front panel graphic display allows continuous display of output current and voltage while setting parameters from the menu-driven keypad. In addition to the front panel and remote interface programming, the MPS includes analog inputs and outputs for setting and monitoring operating parameters and requires only 7 inches of rack space.

Other conventional MPS's: Some use a compliance limited output with current monitoring to charge the magnet. Others require output current to drive against the output current limit to prevent output current drift. Most use multi-turn potentiometers and digital (or analog) panel meters for front panel current and compliance voltage setting. The elegance and repeatability of keypad entry is not available. There is no digital setting or monitoring integration in the output control circuitry. Most achieve computer interfacing by adding computer controlled voltage sources to analog program the output current and voltage. Additional inputs must be added to digitize the output current and voltage. Setting and monitoring resolution is one to two orders of magnitude poorer than the standard MPS provides. External setting and monitoring complicates cabling. Degradation of the output current stability due to the addition of external cabling is undefined. Output noise specifications are rarely given and sometimes vary with the type of magnet load driven. These multiple unit configurations require up to 36 inches of rack space.

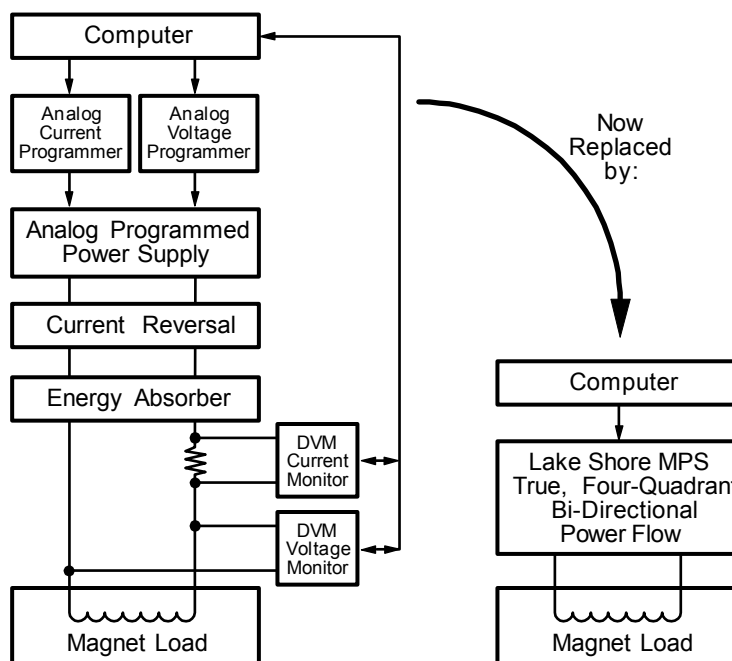

Figure 1-2 Comparison of Old and New MPS Designs

1.3.3 Highly Efficient, Air Cooled, Compact Unit

Model 647 MPS: Quiet switched-mode design. The output uses a proprietary pulse width modulated technique that incorporates power hybrid circuitry. Extremely low conduction loss components minimize internal power dissipation. The MPS is not a direct off-line switching supply. The output is fully floating and isolated from ground. Active power factor correction draws a sinusoidal AC current waveform from the utility, minimizes AC line harmonics, and lowers AC current required. Power factor is the ratio of real power (measured in watts) to the apparent power (measured in volt-amperes). The combination of quiet switched-mode design and active power factor correction results in a compact, highly efficient, air-cooled unit.

Other conventional MPS's: Most use linear regulated outputs. The output transistor pass-bank internally dissipates power not delivered to the magnet. Some units use an off-line switching supply to provide the bulk power and add output regulation. There is no input power factor correction. Low overall efficiency means higher input power and current. Without power factor correction, a non-sinusoidal current with high peaks places tremendous stress on fuses, circuit breakers, outlets, and wiring. Dedicated lines may be required because of potential interaction with other equipment. These factors result in low overall efficiency, large size, and considerable weight.

This Page Intentionally Left Blank

CHAPTER 2

INITIAL SETUP AND CONNECTIONS

2.1 INSPECTING AND UNPACKING

The MPS ships in a special cardboard box with integrated forklift skid openings. Do not stack anything on top of the MPS box. Upon receipt, set the box on a level surface with the pallet side down. Inspect the shipping container for external damage. Make all claims for damage (apparent or concealed) or partial loss of shipment in writing to Lake Shore within five (5) days from receipt of goods. If damage or loss is apparent, notify the shipping agent immediately.

Cut off the plastic strapping and lift off the lid. Locate the MPS packing list and use it to check for receipt of all components, cables, accessories, and manuals. Inspect each item for damage. Use two people to lift the MPS. Retain internal packing material and box for reshipment. Fill out and send the warranty card.

If there is freight damage to any instruments, promptly file proper claims with the carrier and insurance company and notify Lake Shore Cryotronics. Notify Lake Shore of any missing parts immediately. Lake Shore cannot be responsible for any missing parts unless notified within 60 days of shipment. See the standard Lake Shore Cryotronics, Inc. Warranty on the A Page (immediately behind the title page).

2.2 MPS MOUNTING

After unpacking the MPS and verifying receipt of all packing list items, mount the instrument in a suitable location. The MPS ships with feet installed and is ready for use as a bench top instrument. The MPS also ships with 19-inch rack mounting hardware installed for mounting in a standard 19-inch rack enclosure.

CAUTION: To install the MPS in a 19-inch rack mount enclosure at any position other than the bottom, install a slide rail or runner to support the MPS.

2.3 ENVIRONMENTAL REQUIREMENTS

Operate the MPS in an area with an ambient temperature range of 20 to 30 °C (68 to 86 °F). The unit may be operated within the range of 15 to 35 °C (59 to 95 °F) with reduced accuracy.

The MPS is intended for laboratory use: no specific humidity or altitude specifications have been determined. However, relative humidity of 20 to 80 percent (no condensation) and altitudes from sea level to 2.4 km (8,000 feet) are generally acceptable.

WARNING: To prevent electrical fire or shock hazards, do not expose this instrument to moisture.

Provide adequate ventilation. The fan-cooled MPS draws air in from the sides and exhausts it from the rear; install it with sufficient space at the rear and sides for air flow. Filter dust and other particulate matter at the site to a reasonable level. For salt air, corrosive gases, or other air pollutants, consult an air-conditioning expert for special filtering arrangements.

2.4 CONNECTING THE MPS TO POWER

Read and thoroughly understand sections 2.4.1 through 2.4.3 and the **safety recommendations in the Forward** before connecting the MPS to power. Failure to do so may expose operating personnel to lethal voltages or damage the magnet and/or MPS.

2.4.1 Power and Ground Requirements

The AC power source for the MPS should be frequency and voltage regulated and isolated from sources that may generate Electromagnetic Interference (EMI). The MPS is designed for single-phase 3-wire alternating current (AC) power; do not use two-wire (without ground) AC power. Lake Shore recommends Ground Fault Interrupter (GFI) and Transient Surge Protection circuitry at the AC source.

In areas where AC voltage varies, consider using a constant voltage transformer. For power outages, consider using an Uninterruptible Power Supply (UPS).

CAUTION: Do not attempt to apply electrical power until the MPS is checked for proper line voltage settings.

Factory-preset MPS line voltage requirements allow proper operation at the shipping destination. The line voltage setting is indicated on the rear panel. Before applying power to the main input power cable, check for correct input power settings for the power source voltage.

Ground the instrument panels and cabinets. The safety ground provides a true ground path for electrical circuitry and, in the event of internal electrical faults such as shorts, carries the entire fault current to ground to protect users from electrical shock. The MPS has a three-conductor power input connector which grounds the MPS chassis when plugged into a 3-wire receptacle.

EMI is both a natural and man-made electromagnetic phenomena which, either directly or indirectly, may degrade electronic system performance. Natural EMI includes thunderstorms, solar disturbances, cosmic rays, etc. Man-made EMI includes fixed and mobile transmitters, high voltage power lines, power tools and appliances, florescent lights, and other equipment containing motors, heaters, etc. Protect the AC source from EMI. Consider transient surge protectors for lightning protection.

2.4.2 MPS Input Power Ratings

Operate the MPS from a nominal 200, 208, 220, or 240 VAC (–10%, +5%) single-phase AC power source, 50 to 60 Hz. Table 2-1 lists the input voltage range and maximum current required for each nominal input. A rear panel label indicates MPS factory-preset nominal line voltage. Normally, the line voltage setting is not changed in the field. Consult the factory to reconfigure the input power.

| Nominal Line Voltage (VAC) | Line Voltage Range (VAC) | Maximum Input Current (A rms) |
|----------------------------|--------------------------|-------------------------------|
| 200 | 180 to 210 | 16 |
| 208 | 188 to 218 | 15 |
| 220 | 198 to 231 | 14 |
| 240 | 216 to 250 | 13 |

Table 2-1 MPS Line Voltage Limits

2.4.3 Input Power Connections

The MPS uses a three-prong detachable input power connector (supplied) to mate with the UL/CSA/IEC approved rear panel AC input connector. The user supplies a three-conductor power cord rated for at least 85 °C operation. Each conductor must be AWG #16 or larger. Larger wires may be required to prevent excessive voltage drop in AC power lines if unit is located an extended distance from the main AC distribution terminals.

WARNING: For proper circuit breaker protection, mate the wire connected to the “L” terminal of the connector to the “L” (hot) side of the line and mate the wire connected to the “N” terminal to the “N” (neutral) side of the line. Mate the wire connected to the “GND” terminal to earth ground. Do not operate this instrument without an adequate ground connection.

CAUTION: Before applying power to the MPS, verify that the AC source matches the line voltage listed on the rear panel.

NOTE: Make connections to the AC power line in accordance with applicable electrical codes. The international color code for identifying utility supply conductors is green/yellow for earth (“GND”), blue for neutral (N), and brown for line (L). The US and Canadian codes are green for earth (“GND”), white for neutral (N), and black for line (L).

Use this procedure to connect input power to the MPS:

1. Loosen the two connector cover screws and open the cover.
2. Slip the strain relief over the power cable with the flanged end at the end to be terminated.
3. Attach the wires to the connector in accordance with prevailing color codes: green or green/yellow to the "GND" terminal, white or blue to the "N" terminal, and black or brown to the "L" terminal.
4. Position the strain relief, close the cover, and then tighten the cover screws.
5. Connect the other end of the power cord to an appropriate AC power source.
6. Plug the power cord into the detachable power connector plug on the MPS rear panel.

2.5 POWER UP

Read and follow instructions in Paragraphs 2.1 - 2.4.3 and safety recommendations in the Forward before applying power to the MPS. Do not connect the MPS to the magnet at this point. Short the output terminals together with a #4 gauge or larger cable. This protects the magnet against incorrect configurations.

Turn on the MPS. It requires approximately 2 seconds for initialization. Initially, all front panel annunciators come on and the alarm sounds for a short time. Within 1 second, the Fault and Persistent Switch Heater On annunciators and the alarm turn off. If the MPS detects a high or low AC line fault, it blinks the front panel Fault annunciator and turns off the input circuit breaker. If this occurs, verify that the AC source matches the line voltage listed on the MPS rear panel. The MPS front panel AC On LED lights any time the MPS is connected to the AC line and the MPS power switch is ON.

Initially, the entire display clears and the alarm sounds for a short time. The MPS initializes itself and displays the model identification. The Normal Display screen appears with a blinking asterisk indicating each update when the unit is in normal operation.

2.5.1 Magnet Cable Connections

WARNING: Turn off the AC power before changing any rear panel connections and verify that all connections are securely tightened before reapplying power.

CAUTION: Initially, setup the MPS without connecting it to the magnet. This lessens the chance for inadvertent damage to the load while the user learns MPS operation.

Make MPS load connections at the +OUT and -OUT terminals on the rear panel. These plated copper bus bars accommodate 1/4 inch mounting hardware. Use load wires heavy enough to limit the voltage drop to less than 0.5 volts per lead. This ensures proper regulation and prevents overheating while carrying the output current. Use remote sensing to compensate for any voltage drop in the load leads and obtain a more accurate voltage reading. Stranded AWG #4 wire is capable of carrying in excess of 125 amperes. Keep conductor temperature under 85 °C for a 35 °C ambient. Table 2-2 lists the ampere capacity and total +OUT and -OUT lead lengths for load connections.

| AWG | Area (mm ²) | Capacity Amperes | Resistivity Ω/1000 feet | Total Lead Length (feet) | | |
|-----|-------------------------|------------------|-------------------------|--------------------------|-------|-------|
| | | | | 75 A | 100 A | 125 A |
| 0 | 53.5 | 245 | 0.09827 | 135 | 101 | 81 |
| 2 | 33.6 | 180 | 0.1563 | 85 | 64 | 51 |
| 4 | 21.2 | 135 | 0.2485 | 53 | 40 | 32 |
| 6 | 13.3 | 100 | 0.3951 | 33 | 25 | — |
| 8 | 8.4 | 75 | 0.6282 | 21 | — | — |

Table 2-2 Load Wire Lengths and Current Capacity

If connecting multiple loads to the unit, use separate pairs of wires to connect each load to the output terminals. Cut each pair of connecting wires as short as possible.

2.5.2 Shielding, Grounding, and Noise

For noise reduction, tightly twist and shield the leads from the MPS to the magnet. Connect the shield to the MPS chassis as shown in figure 2-4.

WARNING: DO NOT place magnet leads in contact with other MPS/system connections or metal parts.

In some instances, the user's measurement leads may pick up noise from the magnet leads. Although this common mode noise may affect the user's measurement it rarely affects the current in the magnet. If the user's measurement is earth grounded, some improvement is almost always possible by tying the –OUT terminal of the MPS to earth ground – either at the MPS chassis or, if the user's system has one, the common system earth ground point.

WARNING: If the – OUT terminal is tied to earth ground, make certain the +OUT cable from the MPS contacts no other earth ground point - it forces the MPS output current into this other ground point. If the other ground point is a small wire, it may melt or catch fire.

2.5.3 MPS Remote Inhibit and Fault Indicator Connections

The MPS has a Fault Indicator (FLT) output and a discrete Remote Inhibit (RI) input which are both interface independent and provide fault indication and remote output shutdown in the event of catastrophic failure. The Fault Indicator relay contact is open when the MPS detects no faults. When the MPS detects an internal fault, a remote inhibit, or an output inhibit, it lights the front panel Fault LED and closes the relay contact. The contact closure alerts other system components of the fault. In an auto-parallel system (up to four MPS units connected in parallel) these signals connect in parallel between each of the MPS units (See Paragraph 2.6 for details on connections between two auto-parallel units). Make connections to a rear panel detachable terminal block defined in Table 2-3 and Figure 2-2.

| TERMINAL | LABEL | DEFINITION |
|----------|--------------|---|
| 1 2 | RI+ RI– | Remote Inhibit – Active low, TTL-compatible input to remotely force the output settings to 0 A and 1 V. Also activate RI by shorting +RI to -RI with a relay contact closure or a switch. |
| 3 4 | FLT+ FLT– | Fault Indicator – A relay contact that closes to indicate a fault. Contact rating: 0.25 A resistive at 100 VDC, 3 W, 25 VA. |
| 5 6 | ON+ ON– | ON Indicator – A relay contact that closes to indicate when the front panel circuit breaker is in the ON position. Contact rating: 0.25 A resistive at 100 VDC, 3 W, 25 VA. |
| 7 | NONE | Factory Use Only. Do not connect to this terminal. |
| 8 | OVP | In auto-parallel MPS configurations, OVP ensures that the activation of one MPS Over Voltage Protection circuit activates all the other parallel MPS units' protection circuits. |

Table 2-3 RI, FLT, ON, and OVP Connections

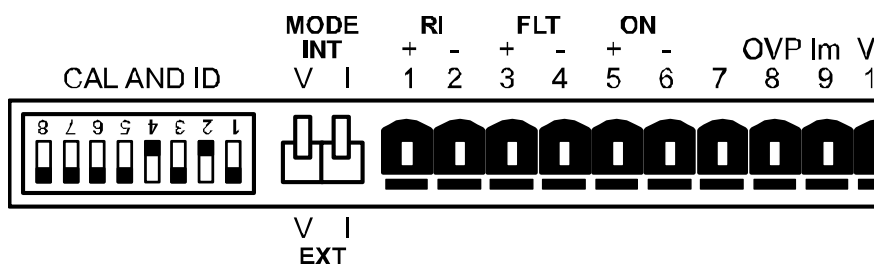

Figure 2-2 RI, FLT, ON and OVP Connections

2.5.4 AC On Indicator

The MPS provides a discrete ON indicator. Terminals 5 and 6 on the terminal block connector, shown in Figure 2-2 above, connect to relay contacts that close when the front panel circuit breaker is in the ON position. There is also a front panel LED that lights when the MPS is ON and connected to AC power.

2.5.5 OVP Connection

In auto-parallel MPS configurations, this connection synchronizes the firing of the Over Voltage Protection (OVP) circuits of each MPS (see Chapter 5). See Paragraph 2.6 and Figure 2-5 for auto-parallel connections.

2.5.6 MPS Analog Current And Voltage Monitoring Connections

The MPS provides amplified and buffered current and voltage monitor output signals at the terminal block on the back panel. Connect these signals to external meters to indicate output current and voltage. Obtain the Current Monitor signal through connections to terminals 9 (Im) and 11 (m) with positive output currents producing a positive monitor voltage of 10 mV/A from Im to m.

Obtain the Voltage Monitor signal through connections to terminals 10 (Vm) and 11 (m) with positive terminal voltages producing a positive monitor voltage of 10 mV/V from Vm to m.

Table 2-4 Analog Monitoring, Programming, & Remote Sense Connections

| TERMINAL | LABEL | DEFINITION |
|----------|-------|--|
| 9 | Im | Output Current Monitor – Voltage output from Im to GND(M) is ± 10 mV/A. |
| 10 | Vm | Output voltage monitor – Voltage output from Vm to GND(M) is ± 10 mV/V. |
| 11 | m | Monitor and program ground. GND(m). |
| 12 | Vp | Not Used. |
| 13 | +Vs | Not Used. |
| 14 | -Is | Negative voltage supply for programming external current with a potentiometer |
| 15 | Ip | Current programming input voltage. Voltage input from Ip to GND(m) produces ± 100 A/V. Voltage may come from a voltage source or from the center tap of a potentiometer connected from -Is to +Is. |
| 16 | +Is | Positive voltage supply for programming external current with a potentiometer. |
| 17 | -S | Remote voltage sense correction. |
| 18 | +S | Correction for load lead drops of up to 0.5 V per lead. |

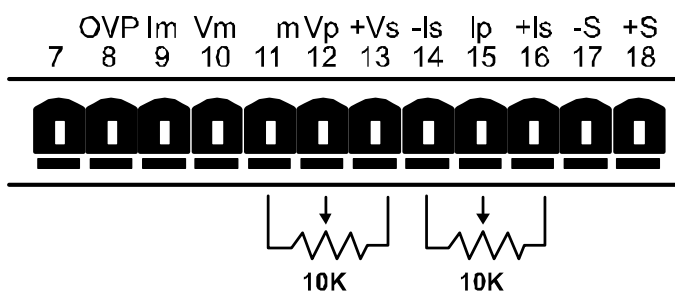

Figure 2-3 Analog Monitoring , Programming, & Remote Sense Connections

2.5.7 External Current Programming

Remotely program MPS output current by an external voltage or potentiometer. Enable external analog programming via the rear panel I MODE switch. When the I MODE switch is in the INT I position, external current mode is disabled. When the I MODE switch is in the EXT I position, the external programming voltage is summed with the internal programming voltage. Set the internal programming to zero for external programming only. Apply an external voltage from Ip to m of 0 to 1.25 volts or use a 10 K Ω potentiometer to control the output current over the entire range. Make connections to rear panel detachable terminal block defined in Tables 2-3 and 2-4 and Figures 2-2 and 2-3. The MPS produces 100 A of output current for 1 V at the current programming input.

NOTE: MPS protection circuits reduce the effect of open external programming leads. An open external programming lead forces external programming voltage to approximately 0 volts.

2.5.8 Remote Sense Connections

The factory configures the MPS to *sense*, but not *control* remote voltage. Call Lake Shore to reconfigure the MPS to *control* voltage at the load. When using remote sense, the MPS measures voltage at the magnet instead of at the MPS output terminals allowing a more accurate reading of magnet voltage by eliminating voltage drops in the leads connecting the MPS to the magnet. If using remote sense, the MPS bases the voltage at the voltage monitor output on the remote sense voltage instead of the MPS terminal voltage.

Use AWG #24, shielded, twisted pair wiring for sense leads to minimize pickup of external noise. Any noise on the sense leads may appear at the unit output. Ground sense shield to the MPS back panel.

Make Remote Sense Connections to rear panel detachable terminal block defined in Table 2-4 and Figure 2-3.

NOTE: The MPS includes a protection circuit which reduces the effect of open sense leads during remote voltage sensing operation. If the +S lead opens, the output voltage changes because it is sensed between +OUT and the negative side of the load. If the -S lead opens, the output voltage changes because it is sensed between the positive side of the load and -OUT. If both leads open, the output voltage is sensed internally.

The procedure below configures the MPS for remote voltage sensing as shown in Figure 2-4.

1. Turn off the unit.
2. If present, disconnect any wires between the +OUT and -OUT terminals and the +S and -S connections on the MPS rear panel.
3. Connect the sense leads from the MPS +S and -S connections to the load. Maintain polarity when making these connections.

CAUTION: Maintain polarity between +S and +OUT and -S and -OUT. The +S and -S inputs control the output voltage. Improper polarity may apply damaging voltages to the load.

4. Connect the ground shield to the mounting screw. Make sure that the shield does not come into electrical contact with either magnet lead.

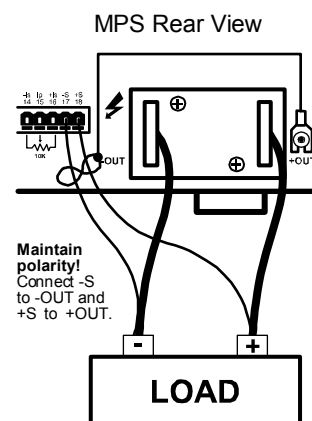

Figure 2-4 Remote Sensing Connections

2.6 MULTIPLE AUTO-PARALLEL SETUP

Connect up to four MPS units in an auto-parallel configuration for increased output current capability. The maximum total current allowed is the sum of the maximum currents of the individual units. For example four 623 MPS units provide $4 \times 155 = 620$ amps total current. The maximum total power is the sum of the maximum power ratings of the individual units.

Assign each unit a unique address: 1 for MPS 1, 2 for MPS 2, etc. The MPS at address 1 polls the control bus to determine if an auto-parallel configuration is present and how many MPS units are involved. When multiple MPS units are present, MPS 1 sends the output current and voltage limits, ramp status, output current step limit, and other operating parameters to the other MPS units so all units operate identically.

For two MPS configuration, each MPS is programmed for half of the total output current. This is true for the ramp destination current and ramp rate. Each MPS contributes half the output current required. MPS 1 software polls MPS 2 to determine the total output current. The output voltage, current settings during a ramp, and instrument status from MPS 1 are reported (since the values are the same for both units.)

An analog signal is also provided for remote activation of the output over voltage protection (OVP) circuit. The signals connect in parallel so that the output OVP circuits of each MPS activate in unison.

CAUTION: Consult Lake Shore prior to operating multiple MPS units in auto-parallel mode.

Use the procedure below and see Figure 2-5 to connect multiple MPS units in auto-parallel configuration:

1. Turn off all units and completely disconnect power at the source before changing MPS configuration.
2. Determine which MPS to assign as MPS 1 and configure it as follows:
 - a. Locate the CAL AND ID DIP switches on the rear panel. Turn ON (up position) switches 1 and 4. Turn OFF (down position) switches 2, 3, and 5 through 8. (Switch 4 ON designates multiple MPS operation. Switches 3, 2, and 1 respectively OFF, OFF, and ON assign the MPS address as 1.) Note that the CAL AND ID switch numbers are upside down (as viewed from the rear panel). Switch 1 is on the right and switch 8 is on the left. Take care to use the correct switch numbers.
 - b. Move the I MODE switch to the INTernal (up) position.
 - c. Locate the Communications Microprocessor (CMP) in the MPS rear panel. The CMP is the module with the two RJ-11 telephone jacks. Loosen the two screws securing the CMP to the MPS rear panel and slide the CMP out. Just inside the CMP front panel, there is a set of DIP switches. Verify that switches 5, 6, and 7 are ON (closed) and switches 1 through 4 and 8 are OFF (OPEN). (Switches 1–4 define the control bus as Serial (RS-232C). Switches 5–8 define the control bus as RS-485 multidrop. Switch 8 terminates the bus for long communications loop runs. Close switch 8 to terminate the control bus only if the MPS units are a significant distance from each other.) Replace the CMP.
3. Configure the second MPS as MPS 2:
 - a. Locate the CAL AND ID switches on the rear panel. Turn ON (up position) switches 2 and 4. Turn OFF (down position) switches 1, 3, and 5 through 8. (Switch 4 ON designates Multiple MPS operation. Switches 3, 2 and 1 as OFF, ON, OFF, respectively, assign the MPS address as 2.)
 - b. Move the I MODE switch to the INTernal (up) position.
 - c. On the CMP, verify that switches 5, 6 and 7 are ON (closed) and switches 1 through 4 and 8 are OFF (OPEN). Replace the CMP.
4. Connect the control bus. Use Lake Shore Model 2001 Modular Cables (provided) to interconnect the two MPS CMP units.
5. Connect the MPS 1 over voltage protection (OVP) pin 8 to MPS 2 pin 8.
6. Connect the RI and FLT signals. Connect the +RI (terminal 1) to the +FLT (terminal 3) on MPS 2. Connect the –RI (terminal 2) to the –FLT (terminal 4) on MPS 2. Do the same on MPS 1. Connect the +RI/+FLT connection of MPS 2 to the +RI/+FLT connection of MPS 1. Connect the –RI/–FLT connection of MPS 2 to the –RI/–FLT connection of MPS 1. If an external contact closure will remotely inhibit operation, connect it across the +RI and –RI terminals of MPS 1. The +FLT and –FLT contact closure of MPS 1 indicates a fault.
7. Connect the +OUT terminal of MPS 1 to the +OUT terminal of MPS 2. Connect the –OUT terminal of MPS 1 to the –OUT terminal of MPS 2. Make these leads as short as possible to minimize output potential differences between the two MPS units and large enough to handle the maximum MPS current. Connect the output terminals to the load using leads large enough to handle the total output current of both MPS units.

NOTE: For proper operation, turn on MPS 1 and then MPS 2 within 15 seconds of MPS 1.

8. Verify all connections as summarized in Table 2-5.
9. To add a third MPS or a fourth MPS in parallel, make the RI/FLT, OVP, CMP and output connections in parallel with the connections of MPS 1 and MPS 2. For MPS 3, set the CAL AND ID switches on the rear panel as follows : switches 5 through 8 are OFF, switches 4, 3, 2 and 1 are ON, OFF, ON, ON respectively. For MPS 4, set the rear panel CAL AND ID switches as follows : switches 5 through 8 are OFF, switches 4, 3, 2 and 1 are ON, ON, OFF, OFF respectively. Configure the CMP switches for MPS 3 and MPS 4 as those in MPS 1 and MPS 2.

| MPS 1 | MPS 2 |
|------------------------|------------------------|
| Control Bus 8 (OVP) | Control Bus 8 (OVP) |
| 1 (+RI), 3 (+FLT) | 1 (+RI), 3 (+FLT) |
| 2 (-RI), 4 (-FLT) | 2 (-RI), 4 (-FLT) |
| +OUT | +OUT |
| -OUT | -OUT |

Table 2-5 Two-MPS Autoparallel Configuration Connections

NOTE: For proper operation, turn on MPS 1 and then the remaining MPS units within 15 seconds.

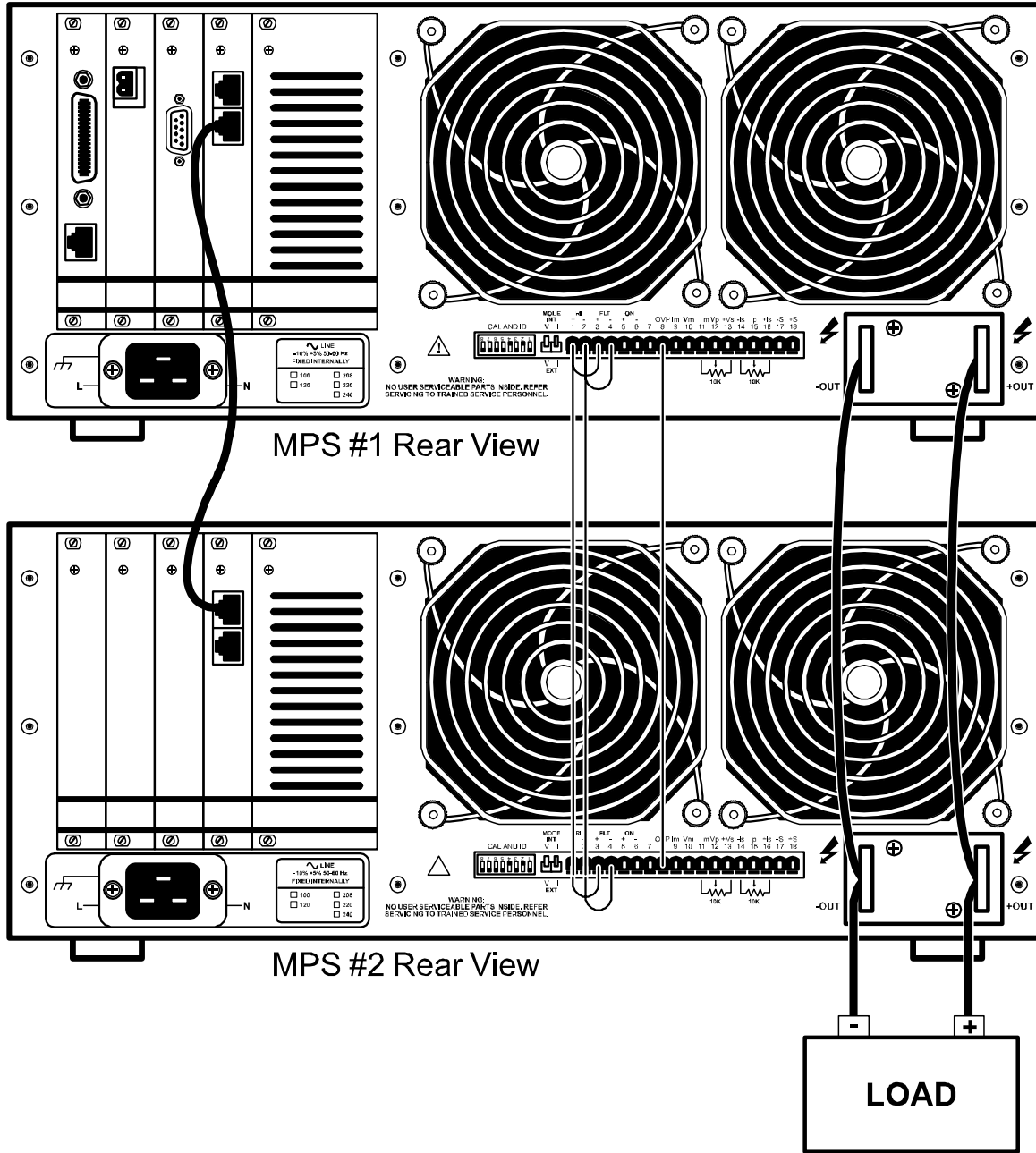

Figure 2-5 Typical Multiple MPS Connections For Two MPS Units

2.7 POST-INSTALLATION INSTRUCTIONS

The MPS is electrically and mechanically inspected and operationally tested prior to shipment. It should be damage-free and in perfect working order upon receipt. To confirm this, visually inspect the instrument for damage and test it electrically to detect any concealed damage upon receipt. Study the entire MPS User's Manual before attempting to run the unit. See Chapter 3 for any questions on front panel control operation.

2.8 SYSTEM SHUTDOWN AND REPACKAGING FOR STORAGE OR SHIPMENT

Follow these general guidelines for system shutdown for storage or reshipment. If returning something, call Lake Shore first to obtain a Return Goods Authorization (RGA) Number.

1. Turn off the power to all instruments. Unplug the power cord.
2. Remove or disconnect any interface cables and the magnet current output cables.
3. Repack the MPS upside down in the original box. If returning the MPS to Lake Shore and original box is unavailable, please call Lake Shore for a replacement box.
4. Label the box for storage or shipment.

2.9 RETURNING EQUIPMENT TO LAKE SHORE

To return the MPS for repair or replacement, obtain a Return Goods Authorization (RGA) number from a factory representative before returning the instrument to our service department. When returning an instrument for service, Lake Shore requires the following information before attempting any repair:

1. Instrument model and serial number
2. User's name, company, address, and phone number
3. Malfunction symptoms
4. Description of system
5. Returned Goods Authorization number

Consult the factory for shipping instructions. Ship the MPS upside down in the original shipping box.

This Page Intentionally Left Blank

CHAPTER 3

OPERATION

3.0 GENERAL

This chapter covers seven areas: MPS Front Panel (Paragraph 3.1), Power Up (Paragraph 3.2), Setting Current on an MPS with Manual PSH Control (Paragraph 3.3), Setting Current with Automatic PSH Control (Paragraph 3.4), Instrument Setup Screens (Paragraph 3.5), Function Menus (Paragraph 3.6), and an Automatic Persistence Control Example (Paragraph 3.7).

Setup the MPS software with the MPS output terminals shorted together as in section 3.2. This ensures that while the user learns MPS operation, an inadvertent keystroke causes no damage to the magnet.

3.1 THE MPS FRONT PANEL

Figure 3.1 below shows the MPS Front Panel. The up or down Display Cursor Control keys move the line indicator to the line containing a value to be changed. Use either the Data Entry Keypad to enter the desired value or the up or down Numeric Entry keys to increment or decrement the value. The Enter key accepts the update, while the Esc key discards the change and returns to the prior value. Move the cursor to a particular digit with the right and left Display Cursor Control keys and change it with the Numeric Entry keys.

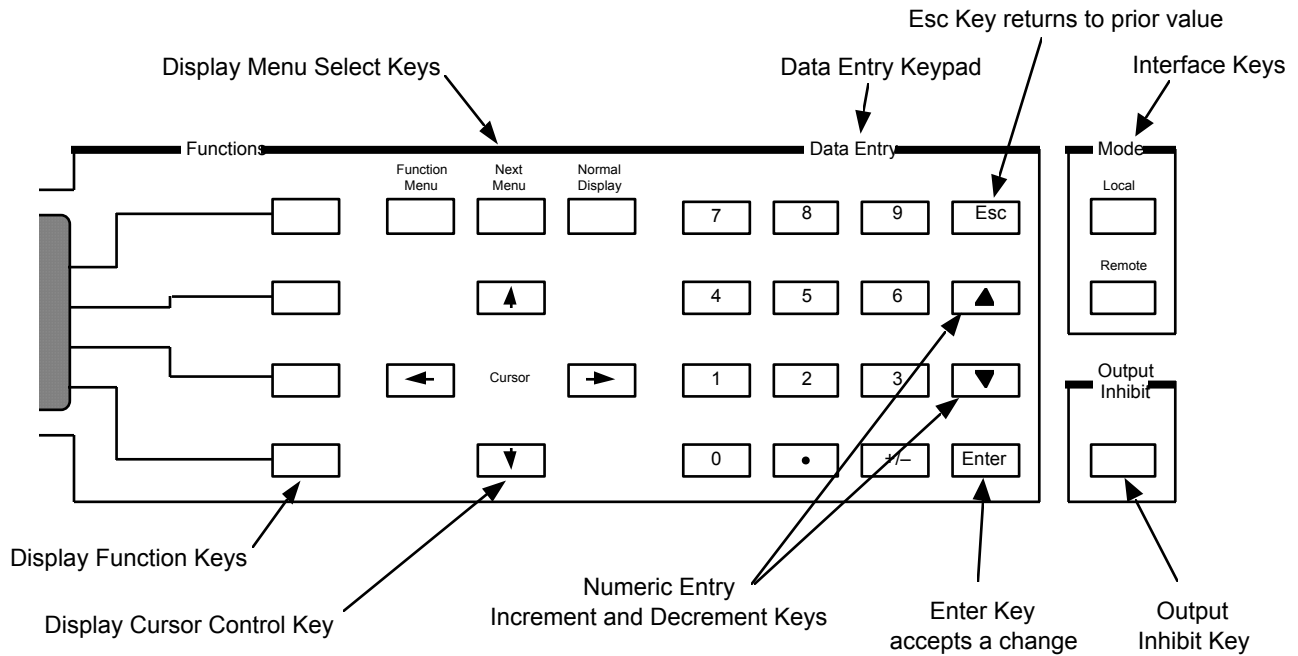

Figure 3-1 Front Panel Numeric Entry Keys

3.2 POWER UP

Read and follow instructions in Paragraphs 2.1 - 2.4.3 and the Forward safety recommendations before applying power to the MPS. **Do not connect the MPS to the magnet yet.** Short the output terminals together with a #4 gauge or larger cable to protect the magnet against incorrect configurations.

Turn on the MPS. It requires approximately 2 seconds for initialization. Initially, all front panel annunciators come on and the alarm sounds for a short time. Within 1 second, the Fault and Persistent Switch Heater On annunciators and the alarm turn off. If the MPS detects a high or low AC line fault, it blinks the front panel Fault annunciator and turns off the input circuit breaker. If this occurs, verify that the AC source matches the line voltage listed on the MPS rear panel.

Initially, the entire display clears and the alarm sounds for a short time. The MPS initializes itself and displays the model identification. The Normal Display screen appears with a blinking asterisk indicating each update when the unit is in normal operation.

CAUTION: Set magnet parameters according to manufacturer's specifications. Failure to do so may damage the magnet and threaten user safety.

3.3 GENERAL DISPLAY DESCRIPTION

In general, screen displays are split into two sections. The left section is the Entry Window where users enter new parameters. The right section is the Menu Window where Menus display when Output values do not. The arrow (+) symbol is the line indicator. The cursor up and down keys move the line indicator.

Shown to the right is the Normal Display screen. It is unique because it allows Settings entry at any time. The IMAX SET and VMAX SET values are the soft current and voltage setting limits. Settings entered cannot exceed these limits. These limits can be changed from the SETUP screen.

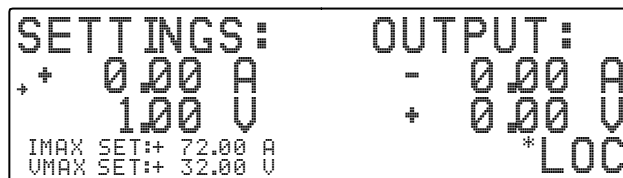

The OUTPUT screen indicates the output values and the interface status. The Normal Display key returns the display to this screen at any time.

3.4 NUMERIC ENTRY

Move the line indicator to the desired line to change a value. Use the Up or down Numeric Entry keys (not cursor keys) to increment or decrement the value. **Enter** accepts the update, while **Esc** returns to the previous value. Use the cursor right and left keys to move the cursor to a particular digit, or enter numbers with the up or down Numeric Entry keys.

3.5 FUNCTION MENU 1 SCREEN

Press **Function Menu** to display Function Menu 1. The 1/3 in the upper right corner indicates Menu 1 of 3. To exit Menu 1, press **Function Menu** again.



3.5.1 Setup Screen

To verify setup, press the **SETUP** Function key. The Setup screen to the right displays with Output values.

Use the Cursor keys to move the line indicator up or down. The up and down arrow icon indicates parameters that can only be changed with the up or down Numeric Entry keys. All others can be changed using all the numeric entry modes, including the cursor. Below are valid Setup entries:

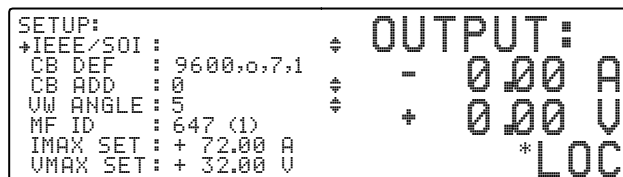

IEEE/SIO:

See Paragraph 4.1.1 to set the optional IEEE/SIO Interface. <NP> indicates the IEEE/SIO option is Not Present.

CB DEF: 9600,0,7,1

The Control Bus Definition is fixed at 9600 Baud, odd parity, 7 data bits, and 1 stop bit. See Appendix B.

CB ADD: 0 to 32

Control Bus Address in the range of 0 to 32. See Appendix B.

VW ANGLE: 2 to 9

Display viewing angle. 9 = view from above, 5 = view in the middle, 2 = view from below. Initial condition is 5. Use the up or down Numeric Entry keys to increment or decrement the value.

MF ID: 647 (1)

MPS ID. 1 = single MPS, 2 = multiple MPS configuration. The MPS and quantity are determined from polling done at power up. This line is skipped in the cursor up and down line selection.

IMAX SET: + 0.00 A to +72.00 A

Soft current limit. A current setting cannot exceed this limit. Initial condition is +72.00 A. Use any numeric entry mode to change the value. See Chapter 5 for error messages and action to take if IMAX is exceeded.

VMAX SET: + 0.00 V to +32.00 V

Soft voltage limit. A voltage setting cannot exceed this limit. Initial condition is +32.00 V. Use any numeric entry mode to change the value. See Chapter 5 for error messages and action to take if VMAX is exceeded.

3.5.2 Output Only Screen

Press the **OUTPUT ONLY** Function key to fill the display screen with the output values.

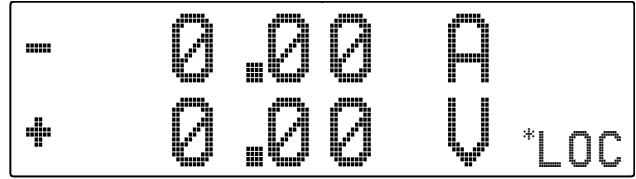

3.5.3 Display Plot Screen

Press the **DISPLAY PLOT** Function key to display a graphic plot of output values on the left side of the display and the current and voltage output values on the right side of the display.

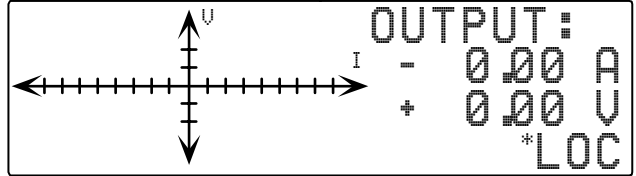

3.5.4 Ramp Status Screen

Press the **RAMP STATUS** Function key to display the Ramp Status screen to the right.

Use the Cursor keys to move the line indicator up or down. The \oplus icon indicates parameters that can only be changed using the up or down Numeric Entry keys. Change all others using all the numeric entry modes, including the cursor. Below are valid Ramp Status entries:

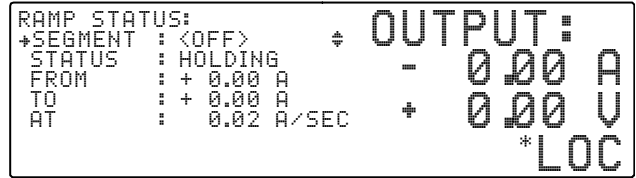

SEGMENT: <OFF> or <ON >

Ramp status. The ramp segment can be put in the Hold (Pause) mode at any time during the ramp. Use the Up or down Numeric Entry keys to toggle the status.

STATUS: HOLDING or RAMPING

Indicates the ramp status. If the ramp is OFF, the status will be HOLDING. If the ramp is on, it will be RAMPING. This line is skipped in the cursor up and down line selection.

FROM: +72.00 A to -72.00 A

Initial ramp current. This value is the present current setting, or the current setting when the ramp was put in hold mode. If the ramp is put in the hold mode, the value will be whatever the current output setting is. When the ramp is complete, this value is changed to the present current setting.

TO: +72.00 A to -72.00 A

Destination ramp current. Use any numeric entry mode to change the value.

AT: 0.00 A/SEC to 99.99 A/SEC

Ramp rate. Use any numeric entry mode to change the value. While ramping, the message "RAMPING / TO HOLD" appears to the left of the interface status. This allows the ramp segment to be put in the hold mode using the Up or down Numeric Entry keys from any screen.

3.6 FUNCTION MENU 2 SCREEN

To determine available secondary functions available, press **Function Menu** to display Function Menu 1. Press **Next Menu** to display Function Menu 2. <NP> indicates the function is "Not Present" and the associated function key is ignored.

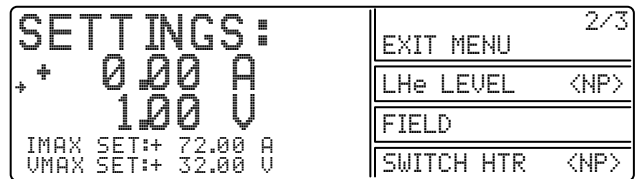

EXIT MENU

Returns to the display screen the Function Menu 2 was entered from.

LHe LEVEL

Liquid Helium Level is not used with the Model 647 and shows <NP>.

FIELD

Enters the Field screen. See Paragraph 6.2.

SWITCH HTR

Persistent Switch Heater is not used with the Model 647 and shows <NP>.

3.7 FUNCTION MENU 3 SCREEN

Press **Function Menu** to display Function Menu 1.
Press **Next Menu** twice to display Function Menu 3.

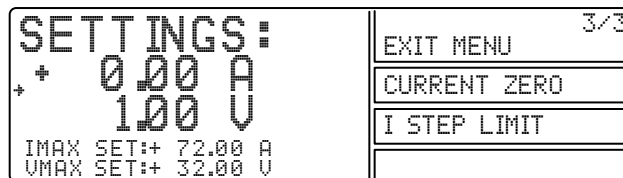

EXIT MENU

Returns to the display screen the Function Menu 3 was entered from.

CURRENT ZERO

Enters the Current Zero screen. See Paragraph 3.7.1.

I STEP LIMIT

Enters the Current Step Limit screen. See Paragraph 3.7.2.

3.7.1 Current Zero Screen

Remotely program MPS current and voltage by external voltages or potentiometers in addition to internal digital programming. Enable external analog programming via the rear panel MODE switches. When the mode switch is in the INT I or V position, external current or voltage programming mode is disabled. When it is in the EXT I or V position, external programming voltage sums with internal programming voltage.

There may be configurations, like multiple auto-parallel MPS units, that introduce an output current offset from zero. This small offset current may translate into a large energy stored in the magnet load. The output current zero feature allows users to zero this output current offset from the MPS front panel. The current zero feature is enabled when either internal or external programming is used. The current zero value stores in non-volatile MPS memory.

Access output current zero from the MPS front panel. Enter a current setting of zero and allow the output current to settle to the offset value. Press the CURRENT ZERO Function key on Function Menu 3 to display the Current Zero screen with the output values. The Up or down Numeric Entry keys toggle the status. If the status is ON, it must be toggled to OFF to clear the old value before a new value is accepted. When the status is toggled ON, the output current stores as the current zero and displays as the I ZERO value.

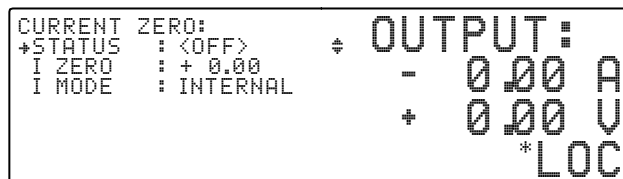

3.7.2 Current Step Limit Screen

When a superconducting magnet quench occurs, the magnet becomes resistive. The output current forces MPS output to the voltage setting (constant voltage mode) and output current drops rapidly. To avoid excessive cryogen boil off, the output current setting should be changed to 0 as quickly as possible.

The output current step limit feature allows users to enter a current step limit which, if exceeded, automatically resets the output settings to 0A and 1V. Press the I STEP LIMIT Function Key on Function Menu 3 to display the Current Step Limit screen.

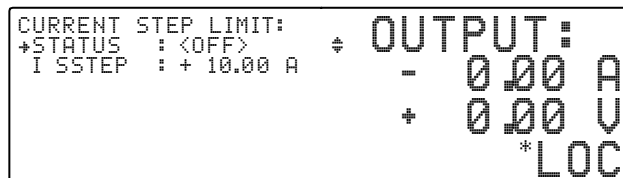

Use the Cursor keys to move the line indicator up and down. The ÷ icon indicates parameters that can only be changed using the up or down Numeric Entry keys. Change all others using all the numeric entry modes, including the cursor. (See Section 3 for keypad operations.) Below are valid Output Current Step Limit entries:

STATUS: <OFF> or <ON>

Output Current Step Limit Status. Use the Up or down Numeric Entry keys to toggle the status.

I STEP + 0.00 A to + 999.99 A

Output Current Step Limit. Use any numeric entry mode to change the value. If the MPS detects a change in output current that exceeds the step limit, it enters Step Limit Mode and forces output settings to 0 amps and 1 volt. On the next update cycle, it closes the FLT contacts to indicate the fault and the internal audio indicator beeps about once per second. See Chapter 5 for error messages and action to take if the Current Step Limit is exceeded.

CHAPTER 4

REMOTE OPERATION

4.0. GENERAL

Either of two computer interfaces available for the Model 647 permit remote MPS operation: the IEEE-488 Interface (Paragraph 4.1) and the Serial Interface (Paragraph 4.2). Use only one of the interfaces at a time. The two interfaces share a common set of commands described in Paragraph 4.3. For further information on RS-485 Mainframe Control Bus Operation, see Appendix C.

4.1. IEEE-488 INTERFACE

The IEEE-488 Interface is an instrumentation bus with hardware and programming standards that simplify instrument interfacing. The MPS IEEE-488 Interface complies with the IEEE-488.2-1987 standard and incorporates the functional, electrical, and mechanical specifications of the standard unless otherwise specified in this manual.

All instruments on the interface bus perform one or more interface function: TALKER, LISTENER, or BUS CONTROLLER. A TALKER transmits data onto the bus to other devices. A LISTENER receives data from other devices through the bus. The BUS CONTROLLER designates to the devices on the bus which function to perform. The MPS performs the functions of TALKER and LISTENER but cannot be a BUS CONTROLLER. The BUS CONTROLLER is the digital computer which tells the MPS which functions to perform.

Below are MPS IEEE-488 interface capabilities:

- **SH1:** Source handshake capability
- **RL1:** Complete remote/local capability
- **DC1:** Full device clear capability
- **DT0:** No device trigger capability
- **C0:** No system controller capability
- **T5:** Basic TALKER, serial poll capability, talk only, unaddressed to talk if addressed to listen
- **L4:** Basic LISTENER, unaddressed to listen if addressed to talk
- **SR1:** Service request capability
- **AH1:** Acceptor handshake capability
- **PP0:** No parallel poll capability

4.1.1 Interface Settings

To use the IEEE-488 interface, the user must set the IEEE Address and Terminators. Press **Function Menu**, then press the key corresponding to **SETUP** to display the Setup screen. Use the cursor keys to move the arrow indicator to **IEEE/SIO**, then press either of the Up or down Numeric Entry keys to display the IEEE Interface screen.

```

SETUP:
+IEEE/SOI :          ⚡
CB DEF   : 9600,0,7,1
CB ADD   : 0          ⚡
VW ANGLE : 5         ⚡
MF ID    : 647 (1)
IMAX SET : + 72.00 A
UMAX SET : + 32.00 U
OUTPUT:
- 0.00 A
+ 0.00 U
* LOC
    
```

IEEE ADD: 1 to 30

Use the cursor keys to move arrow indicator to IEEE ADD. The Up or down Numeric Entry keys increment or decrement the IEEE Address. The default value is 12. The range of choices is from 1 to 30.

```

IEEE INTERFACE:
+IEEE ADD : 12      ⚡
TERMS    : (CR)(LF) ⚡
EOI      : <ON>    ⚡
RS-232 INTERFACE:
BAUD     : 9600     ⚡
DEF      : 0,7,1
OUTPUT:
- 0.00 A
+ 0.00 U
* LOC
    
```

TERMS: CR LF, LF CR, LF, DAB

Use the cursor keys to move the arrow indicator to TERM. The Up or down Numeric Entry keys cycle through the following choices: (CR LF), (LF CR), (LF), (DAB). The default is Carriage Return and Line Feed (CR LF).

EOI: ON or OFF

Use the cursor keys to move the arrow indicator to **EOI**. The Up or down Numeric Entry keys toggle EOI On or Off. The default is On. If turned on, End Or Identify is asserted during the last byte of a multibyte transfer.

BAUD: 300, 1200, 9600

Use the cursor keys to move the arrow indicator to **BAUD**. The Up or down Numeric Entry keys cycle through the following baud rates for the RS-232 interface: 300, 1200, 9600.

4.1.2 IEEE-488 Command Structure

The Model 647 supports several command types. There are three groups of commands:

1. Bus Control – see Paragraph 4.1.2.1.
 - a. Universal
 - (1) Uniline
 - (2) Multiline
 - b. Addressed Bus Control
2. Common – see Paragraph 4.1.2.2.
3. Interface and Device Specific – see Paragraph 4.1.2.3.

4.1.2.1 Bus Control Commands

A Universal Command addresses all devices on the bus. Universal Commands include Uniline and Multiline Commands. A Uniline Command (Message) asserts only a single signal line. The MPS recognizes two of these messages from the BUS CONTROLLER: **Remote (REN)** and **Interface Clear (IFC)**. The MPS sends one Uniline Command: **Service Request (SRQ)**.

REN (Remote) – Puts the MPS into remote mode.

IFC (Interface Clear) – Stops current operation on the bus.

SRQ (Service Request) – Tells the bus controller that the MPS needs interface service.

A Multiline Command asserts a group of signal lines. All devices equipped to implement such commands do so simultaneously upon command transmission. These commands transmit with the Attention (ATN) line asserted low. There are two Multiline commands recognized by the MPS:

LLO (Local Lockout) – Prevents the use of instrument front panel controls.

DCL (Device Clear) – Clears MPS interface activity and puts it into a bus idle state.

Finally, Addressed Bus Control Commands are Multiline commands that must include the MPS listen address before the instrument responds. Only the addressed device responds to these commands. The MPS recognizes three of the Addressed Bus Control Commands:

SDC (Selective Device Clear) – The SDC command performs essentially the same function as the DCL command except that only the addressed device responds.

GTL (Go To Local) – The GTL command is used to remove instruments from the remote mode. With some instruments, GTL also unlocks front panel controls if they were previously locked out with the LLO command.

SPE (Serial Poll Enable) and **SPD (Serial Poll Disable)** – Serial polling accesses the Service Request (SRQ) Status Register. This status register contains important operational information from the unit requesting service. The SPD command ends the polling sequence.

4.1.2.2 Common Commands

Common Commands are addressed commands which create commonality between instruments on the bus. All instruments that comply with the IEEE-488 1987 standard share these commands and their format. Common commands all begin with an asterisk. They generally relate to “bus” and “instrument” status and identification. Common query commands end with a question mark (?). See Paragraph 4.3 for a complete listing of all MPS common commands.

4.1.2.3 Interface and Device Specific Commands

Device Specific Commands are addressed commands. The MPS supports a variety of Device Specific commands to program instruments remotely from a digital computer and to transfer measurements to the computer. Most Device Specific Commands perform functions also performed from the front panel. This section discusses Common and Device Specific commands. Device Specific Commands consist of Interface, Display, Channel, Control Process and Curve commands. See Paragraph 4.3 for a complete listing of all MPS interface and device specific commands.

4.1.3 Status Registers

There are two status registers: the Status Byte Register (Paragraph 4.1.3.1), and the Standard Event Status Register (Paragraph 4.1.3.2).

4.1.3.1 Status Byte and Service Request Enable Registers

The Status Byte Register consists of a single data byte containing seven bits of MPS status information.

STATUS BYTE REGISTER FORMAT

| | | | | | | | | |
|------------|------------|------------|------------|------------|------------|------------|------------|-----------|
| 7 | 6 | 5 | 4 | 3 | 2 | 1 | 0 | Bit |
| 128 | 64 | 32 | 16 | 8 | 4 | 2 | 1 | Weighting |
| SDR | SRQ | ESB | OVP | ERR | RSC | LIM | ODR | Bit Name |

If the Service Request is enabled, any bits that are set cause the MPS to pull the SRQ management low to signal the BUS CONTROLLER. These bits reset to zero upon a serial poll of the Status Byte Register.

The Service Request Enable Register inhibits or enables any of the status reports in the Status Byte Register. The *SRE command sets the bits. A bit that is set enables its function. Inhibit these reports by turning OFF their corresponding bits in the Service Request Enable Register. Refer to the *SRE discussion.

Setting Data Ready (SDR) Bit (7). When set, the MPS resets current and voltage to 0 A and 1 V because of OVP or RI activity.

Service Request (SRQ) Bit (6). Determines whether the MPS is to report via the SRQ line and five bits determine which status reports to make. If bits 0, 1, 2, 3, 4 and/or 5 are set, then the corresponding bit in the Status Byte Register is set. The MPS produces a service request only if bit 6 of the Service Request Enable Register is set. If disabled, the Status Byte Register can still be read by the BUS CONTROLLER by means of a serial poll (SPE) to examine the status reports, but the Service Request does not interrupt the BUS CONTROLLER. The *STB common command reads the Status Byte Register but does not clear the bits. Certain bits in the Status Byte Register continually change. Above are bit assignments in the Status Byte Register. These reports occur only if the bits are enabled in the Service Request Enable Register.

Event Status (ESB) Bit (5). When set, it indicates if one of the bits from the Standard Event Status Register has been set. (Refer to Paragraph 4.1.4.2.)

Overvoltage Protection (OVP) Bit (4) Indicates overvoltage (quench) protection circuit activation.

Error (ERR) Bit (3). Indicates operation error. The error displays on the front panel and can be read using the *TST? Command.

Ramp Segment Complete (RSC) Bit (2). Indicates active ramp segment completion.

Limit Exceeded (LIM) Bit (1). Indicates a new current or voltage exceeds the current or compliance voltage limit. Read the new setting with the ISET? or VSET? commands.

Output Data Ready (ODR) Bit (0). When set, makes current and voltage readings available.

4.1.3.2 Standard Event Status and Standard Event Status Enable Registers

The Standard Event Status Register supplies various conditions of the instrument.

STANDARD EVENT STATUS REGISTER FORMAT

| | | | | | | | | |
|------------|----------|------------|------------|------------|------------|----------|------------|-----------|
| 7 | 6 | 5 | 4 | 3 | 2 | 1 | 0 | Bit |
| 128 | 64 | 32 | 16 | 8 | 4 | 2 | 1 | Weighting |
| PON | not used | CME | EXE | DDE | QYE | not used | OPC | Bit Name |

Bits 2 and 6 are not used. The reports of this register occur only if the bits are enabled in the Standard Event Status Enable Register along with bit 5 of the Service Request Enable Register.

The Standard Event Status Enable Register enables any of the Standard Event Status Register reports. The Standard Event Status Enable command (*ESE) sets the Standard Event Status Enable Register bits. Set a bit to enable its function. To set a bit, send the *ESE command with the bit weighting for each bit to set added together. See the *ESE command for further details.

The Standard Event Status Enable Query, *ESE?, reads the Standard Event Status Enable Register. *ESR? reads the Standard Event Status Register. Once this register is read, all bits are reset to zero.

Power On (PON) Bit (7). This bit is set when the power cycles from OFF to ON.

Command Error (CME) Bit (5). Set upon detection of a command error since the last reading. This means the instrument could not interpret the command due to a syntax error, unrecognized header, unrecognized terminators, or unsupported command.

Execution Error (EXE) Bit (4). Set upon detection of an execution error. Occurs when the instrument is instructed to do something outside its capabilities.

Device Dependent Error (DDE) Bit (3). Reserved for future use.

Query Error (QYE) Bit (2). Indicates a query error. Occurs rarely and involves loss of data due to a full output queue.

Operation Complete (OPC) Bit (0). Generated in response to the *OPC (operation complete) common command. It indicates MPS completion of all selected pending operations.

4.1.4 Example IEEE Setup and Program

Below is an example of how to setup and run a simple program using the built-in MPS IEEE-488 Interface. It does not reflect every hardware/software configuration found in the field. This example uses the National Instruments GPIB - PCII/IIA card and QuickBasic 4.0 or 4.5 on a PC compatible.

4.1.4.1 GPIB Board Installation

Use the following procedure to install the GPIB Board.

1. Install GPIB-PCII/IIA card using National Instruments instructions.
2. Install NI - 488.2 software (for DOS). Version 2.1.1 was used for the example.
3. Verify that config.sys contains the command: device = C:\GPIB.COM
4. Reboot the computer.
5. Run IBTEST to test software configuration. Do not install the instrument before running IBTEST.
6. Run IBCONF to configure the GPIB - PCII/IIA board and dev 12. Set the EOS byte to 0AH. See setup in Fig 4-1. IBCONF modifies gpib.com.
7. Connect the instrument to the interface board and power up the instrument. Verify the address as 12 and the terminators as CR LF.

4.1.4.2 Run The Example QuickBasic Program

Use the following procedure to run the QuickBasic Program.

1. Copy c:\gpib-pc\Qbasic\qbib.obj to the QuickBasic directory (QB4).
2. Change to the QuickBasic directory and type: `link /q qbib.obj,,,bq1b4x.lib` where x = **0** for QB4.0 and **5** for QB4.5 This one-time only command produces the library file qbib.qib. The procedure is found in the National Instruments QuickBasic readme file Readme.qb.
3. Start QuickBasic. Type: `qb /l qbib.qib`. Start QuickBasic in this way each time the IEEE interface is used to link in the library file.
4. Create the IEEE example interface program in QuickBasic. See Table 4-1. Name the file "ieeeeexam.bas" and save.
5. Run the program.

4.1.5 Notes On Using the IEEE Interface

- The term "free field" indicates a floating decimal point that may be placed any appropriate place in the string of digits.
- **[term]** indicates where the user places terminating characters or where they appear on a returning character string from the MPS.
- To chain commands together, insert a semi-colon, comma, or blank space between them. Some programming languages allow only blank spaces to chain. Multiple queries cannot be chained. The MPS responds to the last query entered when addressed as a talker.
- Queries generally use the same syntax as an associated setting command followed by a question mark. They most often return the same information that is sent. Some queries have no command form.
- Leading zeros and zeros following a decimal point are unneeded in a command string, but they are sent in response to a query. A leading "+" is not required, but a leading "-" is required.
- As characters are received over the interface, they store in a buffer with a length of 95 characters. After receiving the terminators, any new parameters are stored. The Mainframe requires about 100 msec to store new parameters before receiving any new commands.
- The Mainframe implements new parameters and updates measurement data once per 500 msec operation cycle (noted by the blinking asterisk to the left of the mode status). Sending new parameters or requesting data at a rate faster than 2 Hz is not recommended.

Table 4-1 Sample BASIC IEEE-488 Interface Program

```

' IEEEXAM.BAS      EXAMPLE PROGRAM FOR IEEE-488 INTERFACE
'
' This program works with QuickBasic 4.0/4.5 on an IBM PC or compatible.
'
' The example requires a properly configured National Instruments GPIB-PC2 card. The REM
' $INCLUDE statement is necessary along with a correct path to the file QBDECL.BAS. CONFIG.SYS
' must call GPIB.COM created by IBCONF.EXE prior to running Basic. There must be QBIB.QBL
' library in the QuickBasic Directory and QuickBasic ' must start with a link to it. All
' instrument settings are assumed to be defaults: Address 12, Terminators <CR> <LF> and EOI
' active.
'
' To use, type an instrument command or query at the prompt. The command transmits to the
' instrument and the MPS receives and displays the response. If no query is sent, the
' instrument responds to the last query received. Type "EXIT" to exit the program. NOTE: The
' INPUT instruction accepts no commas as part of an input string. If a comma appears in an
' instrument command, replace it with a space.
'
'
' REM $INCLUDE: 'c:\gpib-pc\qbasic\qbdecl.bas'      'Link to IEEE calls
' CLS                                             'Clear screen
' PRINT "IEEE-488 COMMUNICATION PROGRAM"
' PRINT
'
' CALL IBFIND("dev12", DEV12%)                  'Open communication at address 12
' TERM$ = CHR$(13) + CHR$(10)                   'Terminators are <CR><LF>
'
' LOOP2: IN$ = SPACE$(2000)                      'Clear for return string
'
' INPUT "ENTER COMMAND (or EXIT):"; CMD$        'Get command from keyboard
' CMD$ = UCASE$(CMD$)                            'Change input to upper case
' IF CMD$ = "EXIT" THEN END                      'Get out on Exit
' CMD$ = CMD$ + TERM$
'
' CALL IBWRT(DEV12%, CMD$)                      'Send command to instrument
'
' CALL IBRD(DEV12%, IN$)                        'Get data back each time
'
' ENDTEST = INSTR(IN$, CHR$(13))                'Test for returned string
' IF ENDTEST > 0 THEN                           'String is present if <CR> is seen
'   IN$ = MID$(IN$, 1, ENDTEST - 1)             'Strip off terminators
'   PRINT "RESPONSE:", IN$                     'Print return string
' ELSE
'   PRINT "NO RESPONSE"                        'No string present if timeout
' END IF
' GOTO LOOP2                                    'Get next command

```

| National Instruments | GPIB0 configuration | GPIB-PC2/2A Ver 2.1 |
|---|---|---------------------|
| Primary GPIB Address..... →0 Secondary GPIB Address..... NONE Timeout setting 10sec Terminate Read on EOS Yes Set EOI with EOS on Writes ... Yes Type of compare on EOS 7-Bit EOS byte 0Ah Send EOI at end of Write..... Yes System Controller Yes Assert REN whe SC No Enable Auto Serial Polling No Enable CIC Protocol No Bus Timing..... 500nsec Parallel Poll Duration Default Use this GPIB board..... Yes Board Type PCII Base I/O Address 02B8h | ↑ Select the primary GPIB address by using the left and right arrow keys. This address is used to compute the talk and listen addresses which identify the board or device on the GPIB. Valid primary addresses range from 0 to 30 (00H to 1EH). * Adding 32 to the primary address forms the Listen Address (LA). * Adding 64 to the primary address forms the Talk Address (TA). EXAMPLE: Selecting a primary address of 10 yields the following: $10 + 32 = 42$ (Listen address) $10 + 64 = 74$ (Talk address) | |
| F1: Help F6: Reset Value F9/Esc: Return to Map Ctl PgUp/PgDn: Next/Prev Board | | |

| National Instruments | DEV12 Configuration | GPIB-PC2/2A Ver 2.1 |
|--|---|---------------------|
| Primary GPIB Address..... →12 Secondary GPIB Address..... NONE Timeout setting 10sec Terminate Read on EOS Yes Set EOI with EOS on Writes ... Yes Type of compare on EOS 7-Bit EOS byte 0Ah Send EOI at end of Write..... Yes Enable Repeat Addressing Yes | ↑ Select the primary GPIB address by using the left and right arrow keys. This address is used to compute the talk and listen addresses which identify the board or device on the GPIB. Valid primary addresses range from 0 to 30 (00H to 1EH). * Adding 32 to the primary address forms the Listen Address (LA). * Adding 64 to the primary address forms the Talk Address (TA). EXAMPLE: Selecting a primary address of 10 yields the following: $10 + 32 = 42$ (Listen address) $10 + 64 = 74$ (Talk address) | |
| F1: Help F6: Reset Value F9/Esc: Return to Map Ctl PgUp/PgDn: Next/Prev Board | | |

Figure 4-1 Typical National Instruments GPIB Configuration from IBCONF.EXE

4.2. SERIAL I/O INTERFACE

RS-232C is a standard of the Electronics Industries Association (EIA) and one of the most common interfaces between a computer and electronic equipment. The Customer supplied computer must have a Serial Interface port. The MPS Serial Interface complies with the electrical format of the RS-232C Interface Standard. A Serial Interface between the computer and the MPS permits remote monitoring and control of MPS control functions, which in turn controls MPS operation. See Figure 4-2.

The Serial Interface can both transmit and receive information. In transmit (Tx) mode, the instrument converts parallel information to serial and sends it over a cable up to 50 feet long (or longer with proper shielding). In receive (Rx) mode, the instrument converts serial information back to parallel for processing.

See Paragraph 4.2.1 for Serial Interface hardware configuration and adapters, Paragraph 4.2.2 for Serial Interface settings, and Paragraph 4.2.3 for a sample BASIC program to establish communications between the computer and the MPS.

The Serial Interface shares Device Specific commands with the IEEE-488 interface listed in Paragraph 4.3. However, without the advantage of the IEEE-488 Architecture, there are several limitations:

- The *OPC and *RST Common Commands are not supported.
- The END Bus Control Command is not supported.
- Terminators are fixed to CRLF.
- A query must be added to the end of a command string if the MPS must return information. (Over IEEE-488, the last query response is sent when addressed to talk.) For example: "ISET 10;ISET?" would set the output current to 10 A and immediately query the output current setting.

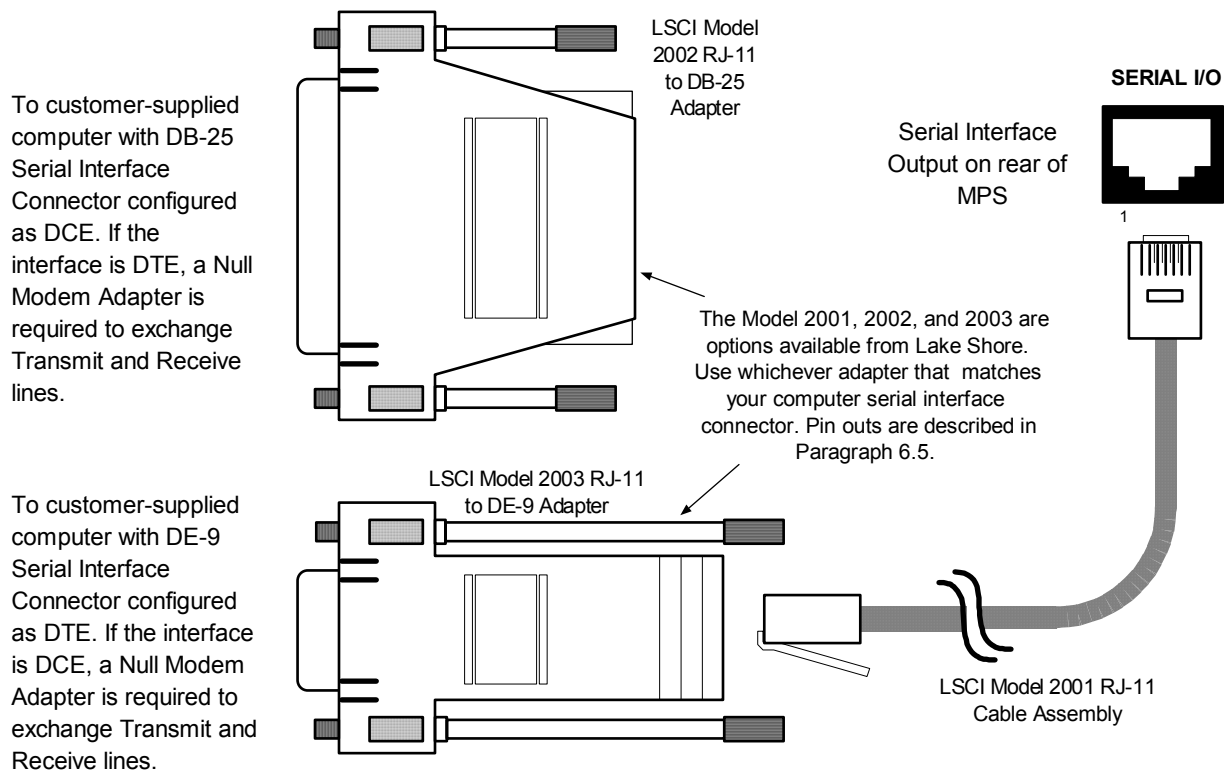

Figure 4-2 Serial Interface Adapters

4.2.1 Serial Interface Hardware Configuration

Below is a technical description of the 6224 option card for the Serial Interface configuration. (**Note:** See Appendix C for Serial Interface on CMP.) Table 4.2 defines communication parameters. Terminators are fixed to Carriage Return (CR) and Line Feed (LF).

The serial interface connector is a standard 6-wire RJ-11 (telephone) jack. Lake Shore offers the Model 2001 10-foot Cable Assembly, Model 2002 RJ-11 to DB-25 Adapter, and the Model 2003 RJ-11 to DE-9 Adapter. See Chapter 4 – Service for Serial I/O connector and adapter pin out details, and Chapter 5 – Options and Accessories for adapter dimensions.

Table 4-2 Serial Interface Specifications

| | |
|---|--|
| Transmission: Three-Wire | Bits per Character: 1 Start, 8 Data, and 1 Stop |
| Baud Rate: 300, 1200 or 9600 | Timing Format: Asynchronous |
| Parity Type: None | Connector: Two RJ-11 Modular Socket |
| Fixed Terminator: CR (0DH) LF (0AH) | Transmission Mode: Half Duplex |
| Data Interface Levels: Transmits & Receives Using EIA Voltage Levels | |

4.2.2 Serial Interface Settings

To use the Serial Interface, set the Baud rate. See Paragraph 4.1.1.

4.2.3 Sample BASIC Serial Interface Program

The QuickBASIC V4.0 program in Table 4.3 is a sample interactive serial poll routine for the MPS Serial Interface. Below are typical examples using this BASIC program. (User input is in **bold type**.)

| | |
|--------------------------------------|---|
| ENTER COMMAND? *IDN? | Identification Query. Returns manufacturer, model number, 0, and Firmware Date. |
| LSCI,622,0,120193 | |
| ENTER COMMAND? ISSET 25;IOUT? | Output Current Setting and Query. Instructs unit to set current to 25 amps and then asks for current reading. |
| +24.9975A | |
| ENTER COMMAND? OVP? | Overvoltage (Quench) Protection Circuit Status Query. Unit returns setting, where 0 = Off and 1 = On. |
| 0 | |
| ENTER COMMAND? RI? | Remote Inhibit Status Query. Unit returns setting, where 0 = Inactive and 1 = Active. |
| 0 | |
| ENTER COMMAND? MODE? | Mode Status Query. Instrument returns mode, where 0 = Local, 1 = Remote, or 2 = Remote with Lockout. |
| 1 | |

4.2.4 Notes On Using The Serial Interface

- To chain commands together, insert a semi-colon (;) between them. Multiple queries cannot be chained.
- Queries use the same syntax as the associated setting command followed by a question mark (?). They usually return the same information that is sent.
- Add a query to the end of a command string if the controller must return information. For example, RMP 0;RMP? commands the MPS to pause the ramp then return the ramp status to confirm the change.
- The MPS returns nothing queries without a "?" and ignores misspelled commands and queries.
- The term "**free field**" indicates a floating decimal point that can be placed at any appropriate place in the string of digits.
- Leading zeros and zeros following a decimal point are unneeded in a command string, but they are sent in response to a query. A leading "+" is not required, but a leading "-" is required.
- **[term]** indicates where the user places terminating characters or where they appear on a returning character string from the MPS.

Table 4-3 Sample BASIC Serial Interface Program

```

SEREXAM.BAS      EXAMPLE PROGRAM FOR SERIAL INTERFACE
'
' This program works with QuickBasic 4.0/4.5 or Qbasic on an IBM PC or compatible
' with a serial interface. It uses the COM1 communication port at 9600 BAUD. Enter
' an instrument command or query at the prompt. The command transmits to the
' instrument which displays any query response. Type "EXIT" to exit the program.
' NOTE: The INPUT instruction in this example accepts no commas as part of an input
' string. If a comma appears in an instrument command, replace it with a space.
'
CLS              'Clear screen
PRINT " SERIAL COMMUNICATION PROGRAM"
PRINT
TIMEOUT = 2000   'Read timeout (may need more)
BAUD$ = "9600"

TERM$ = CHR$(13) + CHR$(10)      'Terminators are <CR><LF>

OPEN "COM1:" + BAUD$ + ",N,8,1,RS" FOR RANDOM AS #1 LEN = 256

LOOP1: INPUT "ENTER COMMAND (or EXIT):"; CMD$ 'Get command from keyboard
CMD$ = UCASE$(CMD$) 'Change input to upper case
IF CMD$ = "EXIT" THEN CLOSE #1: END 'Get out on Exit
CMD$ = CMD$ + TERM$
PRINT #1, CMD$; 'Send command to instrument

IF INSTR(CMD$, "?") <> 0 THEN 'Test for query
RS$ = "" 'If query, read response
N = 0 'Clr return string and count

WHILE (N < TIMEOUT) AND (INSTR(RS$, TERM$) = 0) 'Wait for response
IN$ = INPUT$(LOC(1), #1) 'Get one character at a time
IF IN$ = "" THEN N = N + 1 ELSE N = 0 'Add 1 to timeout if no chr
RS$ = RS$ + IN$ 'Add next chr to string
WEND 'Get chrs until terminators

IF RS$ <> "" THEN 'See if return string is empty
RS$ = MID$(RS$, 1, (INSTR(RS$, TERM$) - 1)) 'Strip off terminators
PRINT "RESPONSE:"; RS$ 'Print response to query
ELSE
PRINT "NO RESPONSE" 'No response to query
END IF
END IF 'Get next command
GOTO LOOP1

```

4.3 SUMMARY OF IEEE-488/SERIAL INTERFACE COMMANDS

Below is an alphabetical list of IEEE-488/Serial Interface commands consisting of Operational Commands (Paragraph 4.3.1.1), Interface Commands (Paragraph 4.3.1.2), Ramping Commands (Paragraph 4.3.1.3), Current Zero Commands (Paragraph 4.3.1.4), Current Step Limit Commands (Paragraph 4.3.1.5), and Common Commands (Paragraph 4.3.1.6).

OPERATIONAL COMMANDS

| <i>Cmd</i> | <i>Function</i> |
|------------|------------------------------|
| ERR? | Error Status Summary |
| IMAX | Upper Current Limit |
| IMAX? | Upper Current Limit Query |
| IOUT? | Output Current Query |
| ISET | Output Current Setting |
| ISET? | Output Current Setting Query |
| IV? | Output Summary Query |
| OVP? | Overvoltage Protection Query |
| RI? | Remote Inhibit Status Query |
| VOUT? | Output Voltage Query |
| VSET | Output Voltage Setting |
| VSET? | Output Voltage Setting Query |

INTERFACE COMMANDS

| <i>Cmd</i> | <i>Function</i> |
|------------|-----------------------------|
| END | EOI Status |
| END? | EOI Status Query |
| MODE | Interface Status Mode |
| MODE? | Interface Status Mode Query |
| TERM | Terminator |
| TERM? | Terminator Query |

RAMPING COMMANDS

| <i>Cmd</i> | <i>Function</i> |
|------------|-------------------------------|
| RAMP | Ramp Segment Parameters |
| RAMP? | Ramp Segment Parameters Query |
| RMP | Ramp Status |
| RMP? | Ramp Status Query |
| SEG | Active Ramp Segment |
| SEG? | Active Ramp Segment Query |

CURRENT ZERO COMMANDS

| <i>Cmd</i> | <i>Function</i> |
|------------|--------------------------------|
| IMODE? | Current Programming Mode Query |
| VMODE? | Voltage Programming Mode Query |
| ZI | Zero Current Value Status |
| ZI? | Zero Current Value Query |
| ZIS | Zero Current Status |
| ZIS? | Zero Current Status Query |

CURRENT STEP LIMIT COMMANDS

| <i>Cmd</i> | <i>Function</i> |
|------------|------------------------------------|
| ISTP | Output Current Step Limit |
| ISTP? | Output Current Step Limit Query |
| ISTPS | Output Current Step Limit Status |
| ISTPS? | Output I Step Limit Status Query |
| STEP? | Output I Step Limit Exceeded Query |
| STEPR1 | Output I Step Limit Exceeded Reset |

COMMON COMMANDS

| <i>Cmd</i> | <i>Function</i> |
|------------|--------------------------------|
| *CLS | Interface Clear |
| *ESE | Std. Event Status Enable Reg |
| *ESE? | Std. Event Status Query |
| *ESR? | Std. Event Status Enable Query |
| *IDN? | Identification Query |
| *OPC | Operation Complete |
| *OPC? | Operation Complete Query |
| *RST | Reset Command |
| *SRE | Service Request |
| *SRE? | Service Request Query |
| *STB? | Status Byte Query |
| *TST? | Self Test Query |
| *WAI | Wait-To-Continue |

See Chapter 6 for additional IEEE-488 commands for the Model 6476 Gaussmeter Input Card and the Model 6477 High Resolution Display and Programming Option.

4.3.1 Commands List Structure Description

COMMAND (Shortcut Command): Short command description.

Input: Syntax of user input.

Returned: Response to command.

Remarks: Further explanation and definition.

4.3.1.1 Operational Commands Description

Below is a list of MPS Operational Commands which configure the various functions.

ERR?: Error Status Query

Input: ERR?

Returned: [OVP] [RI] [STEP]

Remarks: Returns **0** if the error is inactive or **1** if it is active. Returns three characters plus up to two terminators.

IMAX: Programs Upper Current Limit

Input: IMAX [current] where [current] = a value between **0** and **+72 A**.

Remarks: Programs the upper (soft) current limit of the MPS. Truncates the value to the 0.001 place. The initial condition is +000.0000 A. The current limit is always forced to a plus. Setting is limited by product limits. Control Bus inputs 4 places, display rounds to 0.01 or 0.001 place.

IMAX?: Current Limit Query

Input: IMAX?

Returned: A number between **0** and **+72 A**.

Remarks: Nine characters plus up to two terminators are returned. Value is shown as a "+," but applies to both positive and negative entries.

IOUT? (I?): Output Current Query

Input: IOUT? or I?

Returned: A number between **±72 A**.

Remarks: Returns nine characters plus up to two terminators.

ISET (I): Enter Output Current

Input: ISET [current] or I [current] where [current] = a value between **±72 A**.

Remarks: Value is truncated to the 0.001 place. Initial condition is +000.0000 A. Setting is limited by IMAX. Control Bus inputs 4 places, display rounds to 0.01 or 0.001 place.

ISET?: Output Current Setting Query

Input: ISET?

Returned: A number between **±72 A**.

Remarks: Returns nine characters plus up to two terminators.

IV?: Output Summary Query

Input: IV?

Returned: [IOUT], [VOUT], [STB], [I MODE], [V MODE]

Remarks: Returns twenty-seven characters plus up to two terminators.

OVP?: Overvoltage (Quench) Protection Circuit Status Query

Input: OVP?

Returned: **0** if the circuit is inactive, or **1** if it is active.

Remarks: One character plus up to two terminators are returned.

RI?: Remote Inhibit Status Query

Input: RI?

Returned: 0 if the remote inhibit is inactive, or 1 if it is active.

Remarks: One character plus up to two terminators are returned.

VOUT? (V?): Output Voltage Query

Input: VOUT? or V?

Returned: A number between 0 and ± 32.0000 V.

Remarks: Returns nine characters plus up to two terminators.

VMAX: Programs an upper (soft) voltage limit that the unit will accept.

Input: VMAX[voltage] where [voltage] = 0 to +32.0000 V.

Remarks: Normal resolution truncates the value to 0.01 place. High resolution truncates the value to the 0.001 place. The initial condition is +000.0000 V. The voltage limit is always forced to a plus.

VMAX?: Voltage Limit Query.

Input: VMAX?

Returned: A value between 0 and +32.0000 V.

Remarks: Returns a nine character value with up to two terminators.

VSET (V): Programs the output voltage in the voltage mode.

Input: VSET[voltage] or V[voltage] where [voltage] = 0 to +32.0000 V.

Remarks: Normal resolution truncates the value to 0.01 place. High resolution truncates the value to the 0.001 place. The initial condition is +00.0000 V. The voltage setting is always forced to a "+." Setting is limited by VMAX. Control Bus inputs 4 places, display rounds to 0.01 or 0.001 place.

VSET?: Output Voltage Setting Query.

Input: VSET?

Returned: A value between 0 and +32.0000 V.

Remarks: Returns a nine character value with up to two terminators.

4.3.1.2 Interface Commands Description

The MPS Interface Commands below help configure IEEE-488 interface compatibility for a variety of computer equipment.

END: Programs MPS Interface EOI (End Or Identify) Status

Input: **END [status]** where **[status]** = **0** to enable the EOI, or **1** to disable it.

Remarks: When enabled, the hardware EOI line becomes active with the last byte of a transfer. Not supported by Control Bus.

END?: End Of Identify (EOI) Query

Input: **END?**

Returned: **0** if EOI is enabled, or **1** if it is disabled.

Remarks: Returns 1 character plus up to 2 terminators. Not supported by Control Bus.

MODE: Programs MPS Interface Mode Status

Input: **MODE [status]** where **[status]** = **0** for local mode, **1** for remote mode, or **2** for remote mode with local lockout. Supported in Control Bus operation.

MODE?: Interface Mode Status Query

Input: **MODE?**

Returned: **0** for local mode, **1** for remote mode, or **2** for remote mode with local lockout.

Remarks: Returns 1 character plus up to 2 terminators. Supported by Control Bus.

TERM: Programs MPS Interface Terminating Characters

Input: **TERM [type]** where **[type]** =
0 for a carriage return and line feed (CR)(LF^{EOI}),
1 for a line feed and carriage return (LF)(CR^{EOI}),
2 for a line feed (LF^{EOI}),
3 for no terminating characters (DAB^{EOI}) DAB = Last Data Byte

Remarks: Terminating characters are sent when the MPS completes its message on output. They also identify the end of an input message. Control Bus fixes terminators at (CR)(LF) on receipt and transmission.

TERM?: Terminator Query

Input: **TERM?**

Returned: **0** for a carriage return and line feed (CR)(LF^{EOI})
1 for a line feed and carriage return (LF)(CR^{EOI})
2 for a line feed (LF^{EOI})
3 for no terminating characters (DAB^{EOI}) DAB = Last Data Byte

Remarks: Control Bus fixes terminators at (CR)(LF) on receipt and transmission.

4.3.1.3 Ramping Commands Description

The following MPS Ramping Commands configure the various functions of the ramping features.

RAMP: Programs Ramp Segment Parameters

Input: **RAMP[segment],[initial ramp current],[final ramp current],[ramp rate],[00],[--:--:--:--]**

where: **[segment]** = 1. (Future updates will allow up to nine segments.)

[initial ramp current] = 0 to ± 72 A.

[final ramp current] = 0 to ± 72 A.

[ramp rate] = 0 to 99.9999 A/S.

[00]: Reserved for future use (Operation to perform). Need not be present for proper command operation.

[--:--:--:--]: Reserved for future use (DWEELL time in days, hours, minutes and seconds). Does not need to be present for proper command operation.

Remarks: Truncates value to 0.001 place. Enter values with no embedded spaces. Undefined parameters are set to 0. Control Bus inputs 4 places, display rounds to 0.01 or 0.001 place.

Example: **RAMP1,+72.0000,-72.0000,01.0000[term]**

Indicates: Ramp Segment = 1;
 Initial Ramp Current = +72.0000 A;
 Final Ramp Current = -72.0000 A;
 Ramp Rate = 01.0000 A/S; commas can be replaced by blanks.

RAMP?: Ramp Parameter Query

Input: **RAMP?**

Returned: Values are the same format as described above for programming in the ramp segments.

Remarks: Returns 48 characters and up to two terminators.

RMP: Programs Ramp Status

Input: **RMP [ramp status]** where **[ramp status]** = 0 to turn off (HOLD) the ramp definitely, or 1 to turn on the ramp segment or continue a ramp on hold.

RMP?: Ramp Status Query

Input: **RMP?**

Returned: 0 for holding, or 1 for ramping.

Remarks: One character plus up to two terminators are returned.

SEG: Programs Active Ramp Segment

Input: **SEG [segment]** where **[segment]** = 1. (Future updates will allow multiple ramp segments).

SEG?: Active Ramp Segment Query

Input: **SEG?**

Returned: 1. (Future updates will allow multiple ramp segments).

Remarks: Returns one character plus up to two terminator.

4.3.1.4 Current Zero Commands Description

The following MPS commands configure the various functions of the current zero features.

IMODE?: Current Programming Mode Query

Input: **IMODE?**

Returned: **0** if I MODE switch is set to EXT, or **1** if set to INT.

Remarks: Returns one character plus up to two terminators. When multiple MPS units are present, the current programming mode of MPS No. 1 is reported.

VMODE?: Voltage Programming Mode Query

Input: **VMODE?**

Returned: **0** if the V MODE switch is set to EXT, or **1** if set to INT.

Remarks: Returns one character plus up to two terminators. When multiple MPS units are present, the voltage programming mode of MPS No. 1 is reported.

ZI: Programs Current Zero Value

Input: **ZI [current zero]** where **[current zero]** = a value between ± 999.9999 .

Remarks: Enter this setting after enabling ZI Status. Control Bus inputs 4 places, display rounds to 0.01 or 0.001 place. If a ZI value is entered over the Control Bus, status automatically turns ON.

ZI?: Current Zero Value Query

Input: **ZI?**

Returned: A number between ± 999.9999 .

Remarks: Returns nine characters plus up to two terminators.

ZIS: Programs Current Zero Status

Input: **ZIS [status]** where **[status]** = **0** to turn OFF the current zero, or **1** to turn it ON.

Remarks: When the current zero is turned off, the current zero value resets to 0.

ZIS?: Current Zero Status Query

Input: **ZIS?**

Returned: **0** if the current zero is OFF, or **1** if it is ON.

Remarks: Returns one character plus up to two terminators.

4.3.1.5 Current Step Limit Commands Description

The following MPS commands configure the various functions of the current step limit features.

ISTP: Programs Output Current Step Limit

Input: **ISTP [step limit]** where **[step limit]** = a value between 0 and +999.9900.

Remarks: Truncates the value to the 0.001 place. The initial condition is +000.000 A. The step limit is forced to a plus. Control Bus inputs 4 places, display rounds to 0.01 or 0.001 place.

ISTP?: Output Current Step Limit Query

Input: **ISTP?**

Returned: A number between 0 and +999.9900 A.

Remarks: Returns nine characters plus up to two terminators. Value is shown as a "+", but applies to both positive and negative step changes.

ISTPS: Programs Output Current Step Limit Status

Input: **ISTPS [status]** where **[status]** = **0** to turn OFF output current step limit, or **1** to turn it ON.

Remarks: The initial condition is **0**.

ISTPS?: Output Current Step Limit Status Query

Input: **ISTPS?**

Returned: **0** for OFF, or **1** for ON.

Remarks: Returns one character plus up to two terminators.

STEP?: Output Current Step Limit Exceeded Query

Input: **STEP?**

Returned: **0** if the step limit has not been exceeded, or **1** if it has been exceeded.

Remarks: Returns one character plus up to two terminators.

STEPR1: Output Current Step Limit Status Reset

Input: **STEPR1**

Returned: Nothing

Remarks: When the output current step limit has been exceeded, this command must be issued before normal operation can be resumed.

4.3.1.6 Common Commands Description

The MPS Common Commands below are input/output commands defined by the IEEE-488 standard and shared with other instruments complying with the standard. Common commands begin with “*”.

*CLS: Clear Status Register Command

Input: *CLS

Returned: Nothing.

Remarks: Clears the Status Register, but *not* the instrument. It clears the bits in the Status Byte Register and the Standard Event Status Register and terminates all pending operations. The instrument-related command is *RST.

*ESE: Enables Status Reports In The Standard Event Status Enable Register

Input: *ESE [bit weighting] where [bit weighting] = the sum of the bit weighting of each bit to be set. The value can be 000 to 255. See the discussion on registers and below.

Remarks: Each bit is assigned a bit weighting. See the format of the Standard Event Status Register (given below) to see bit weighting and register placement. Further explanation of each bit is discussed in the register section following the Common Command Table. See Paragraph 4.1.3.2 for a complete description of status bits.

| | | | | | | | | |
|------------|----------|------------|------------|------------|------------|----------|------------|-----------|
| 7 | 6 | 5 | 4 | 3 | 2 | 1 | 0 | Bit |
| 128 | 64 | 32 | 16 | 8 | 4 | 2 | 1 | Weighting |
| PON | not used | CME | EXE | DDE | QYE | not used | OPC | Bit Name |

Example: To set a bit, send the command *ESE with the sum of the bit weighting for each bit desired. For example, to set bits 0, 3, 4, and 5, send the command *ESE57. 57 is the sum of the bit weighting for each bit:

| | |
|-----|-----------|
| Bit | Weighting |
| 0 | 1 |
| 3 | 8 |
| 4 | 16 |
| 5 | <u>32</u> |
| | 57 |

*ESE?: Standard Event Status Enable Query

Input: *ESE?

Returned: An integer between **000** and **255**.

Remarks: Reads the Standard Event Status Enable Register. The integer returned represents the bits set in the Standard Event Status Enable Register. It is a sum of the bit weighting of each bit set. Returns three digits plus up to two terminators.

*ESR?: Standard Event Status Register Query

Input: *ESE?

Returned: An integer between **000** and **255**.

Remarks: Reads the Standard Event Status Register. The integer returned represents bits set in the Service Request Enable Register. It is a sum of the bit weighting of each bit set. This Query supplies various error conditions and whether the MPS has been powered off and on since the last query. Returns three digits plus up to two terminators.

***IDN?**: Identification Query

Input: *IDN?

Returned: Manufacturer, Model Number, Model Serial Number, Firmware Date.

Remarks: Returns seventeen characters plus up to two terminators.

Example: LSCI,622,0,120193[term]

***OPC:** Operation Complete Status

Input: *OPC

Returned: Nothing.

Remarks: Causes the MPS to set an update cycle counter to 2. Each time through an update cycle, parameters entered by device dependent commands update and the cycle count decrements. Two update cycles complete all pending device dependent commands. When this occurs, the MPS sets the operation complete bit in the Standard Event Status Register (not the IEEE-488.2 defined operation). Not supported by Control Bus.

***OPC?:** Operation Complete Status Query

Input: *OPC?

Returned: 0 or 1, where 0 indicates incomplete, 1 indicates complete.

Remarks: Places 1 in the instrument output queue and sets the Operation Complete Bit in the Standard Event Status Register upon completion of all pending selected device operations. This must be sent as the last command in a command string. Returns one character plus up to two terminators. Not supported by Control Bus.

***RST:** Instrument Reset Command

Input: *RST

Returned: Nothing.

Remarks: Restores MPS to power-up settings just like the DCL and SDC bus commands. The MPS reverts to the Normal Display Screen, forces ramp status to the Hold mode, and clears any latched error along with the Status Byte and the Standard Event Status Registers. Not supported by Control Bus.

***SRE:** Enables Status Reports In The Service Request Enable Register

Input: *SRE [bit weighting] where [bit weighting] = the sum (000 to 255) of bit weighting of each bit to be set. See the discussion on registers and below.

Remarks: Each bit is assigned a bit weighting. See the format of the Status Byte Register (given below) to see weighting and register placement of bits. See the register section following the Common Command Table. See Paragraph 4.1.3.1 for a complete description of status bits.

| | | | | | | | | |
|------------|------------|------------|------------|------------|------------|------------|------------|-----------|
| 7 | 6 | 5 | 4 | 3 | 2 | 1 | 0 | Bit |
| 128 | 64 | 32 | 16 | 8 | 4 | 2 | 1 | Weighting |
| SDR | SRQ | ESB | OVP | ERR | RSC | LIM | ODR | Bit Name |

Example: If a bit in the Service Request Enable Register is set (1), its function is enabled and reported in the Status Byte Register. For example, to enable bits 1, 2, 4 and 6, send the command ***SRE86**. 86 is the sum of the bit weighting for each bit:

| <u>Bit</u> | <u>Weighting</u> |
|------------|------------------|
| 1 | 2 |
| 2 | 4 |
| 4 | 16 |
| 6 | <u>64</u> |
| | 86 |

***SRE?:** Service Request Enable Query

Input: *SRE?

Returned: An integer from **000-255**.

Remarks: Reads the Service Request Enable Register. The integer returned represents the sum of the bit weighting of each bit set. Returns three digits plus up to two terminators.

***STB?:** Status Byte Query

Input: *STB?

Returned: An integer from **000-255**.

Remarks: Reads the Status Byte Register. The integer returned represents the sum of the bit weighting of each bit set. Although this query acts like a serial poll, it does not reset the register to all zeros. Returns three digits plus up to two terminators.

***TST?:** Self Test Query

Input: *TST?

Returned: 0 = No errors 3 = Reserved 6 = AC High 9 = OI Active
 1 = Remote Inhibit Active 4 = STP Error 7 = Rail High
 2 = OVP Active 5 = AC Low 8 = Overtemperature Error

Remarks: Causes instrument to report any failures. Returns 1 character plus up to 2 terminators.

***WAI:** Wait-to-Continue Command

Input: *WAI

Returned: Nothing.

Remarks: The command prevents the instrument from executing any further commands or queries until all previous ones have been serviced. This command is accepted but not supported (not the IEEE-488.2 defined operation). Not supported by the Control Bus.

CHAPTER 5

ERROR MESSAGES AND TROUBLESHOOTING

5.0 GENERAL

This chapter covers Software Error Messages (Paragraph 5.1), Factory Default Settings (Paragraph 5.2), Calibration Procedure (Paragraph 5.3), Performance Test (Paragraph 5.4), Rear Panel Connectors Definition (Paragraph 5.5), IEEE-488 Connector Definition (Paragraph 5.6), and Serial Interface Cable and Adapters (Paragraph 5.7).

5.1 SOFTWARE ERROR MESSAGES

The MPS constantly monitors its circuits for faults like low or high line voltage, line loss, or internal temperature and rail faults. Upon detection, the error and a brief description display. Below are error messages that may display during normal operation:

Error 01 – Unwriteable NOVRAM Error

```

ERROR 01:
AN UNWRITEABLE NOVRAM DATA LOCATION
EXISTS IN THE CONTROL UNIT. INITIALIZE
THE NOVRAM BY PRESSING THE Esc KEY FOR
10 SECONDS. IF THE ERROR STILL EXISTS,
CONTACT LSCI FOR A REPLACEMENT NOVRAM.
    
```

Error 02 – NOVRAM Data Verification Error

```

ERROR 02:
A NOVRAM VERIFICATION ERROR
EXISTS IN THE CONTROL UNIT. INITIALIZE
THE NOVRAM BY PRESSING THE Esc KEY FOR
10 SECONDS. IF THE ERROR STILL EXISTS,
CONTACT LSCI FOR A REPLACEMENT NOVRAM.
    
```

Error 06 – Calibration Data NOVRAM Error

```

ERROR 06:
A CALIBRATION DATA NOVRAM ERROR EXISTS
IN THE MAINFRAME. MAINFRAME CALIBRATION
MUST BE PERFORMED. CONTACT LSCI.
    
```

Output Current Step Limit Exceeded

If the MPS detects an output current change that exceeds the step limit, it enters Step Limit Mode and forces MPS output to 0 amps and 1 volt. On the next display update cycle, the MPS closes the FLT contacts to indicate the fault, sounds an alarm about once per second, and displays:

```

I STEP LIMIT EXCEEDED: OUTPUT:
OUTPUT CURRENT CHANGED - 0.00 A
MORE THAN THE I STEP
LIMIT IN ONE UPDATE. + 0.00 V
THE OUTPUT SETTINGS ARE
FORCED TO 0 A AND 1 V. STP *LOC
PRESS ↵ TO CLEAR ERROR.
    
```

The MPS sounds the alarm and halts operation until the user presses a Data Entry up (▲) or down (▼) key to clear the fault. When the fault clears, the MPS opens the FLT contacts, silences the alarm, and displays the normal display.

Remote Inhibit (RI) Detected

The Remote Inhibit (RI) and Fault (FLT) indicators provide hardware fault indication and remote shutdown in addition to internal protection features. The FLT indicator is a set of normally closed contacts when the unit is OFF. When the unit is ON and no fault is present, the contacts are open. If the MPS detects a fault or an RI input assertion from an external contact closure, it enters Remote Inhibit Mode, forces output settings to 0 amps and 1 volt, and turns ON the front panel Fault annunciator. The MPS closes the FLT contacts to indicate a fault, sounds the alarm once per second, and displays:

```

REMOTE INHIBIT: OUTPUT:
THE OUTPUT SETTINGS ARE - 0.00 A
FORCED TO 0 A AND 1 V.
THE OUTPUT SETTINGS + 1.00 V
CANNOT BE CHANGED UNTIL
RI IS RELEASED. RI *LOC
    
```

The alarm stops sounding when RI is removed, but the MPS continues to display RI until the user enters new output settings, then turns them OFF. This latching action informs the user of RI activity.

When the MPS detects no RI input activity, it turns OFF the front panel Fault annunciator and internal alarm, and opens the FLT contacts. When the MPS software detects open FLT contacts (RI is inactive), it displays the Normal Display.

To insert a 2 to 3 second delay between RI activation and the initial fault operation, turn CAL AND ID switch 7 ON (up); the MPS polls for RI activity after the delay. If RI is still active, the fault operation continues; if not, it is ignored.

In multiple MPS configuration, if an external contact closure activates the MPS RI indicators, the MPS units enter Multiple MPS Remote Inhibit Mode. They activate their output over voltage protection (OVP) circuits and turn off their output circuits. If a charged load is present, the OVP circuits discharge it, the front panel Fault annunciators turn ON, and the alarm sounds about once per second. If a MPS detects a fault, it closes the FLT contacts to initiate Multiple MPS Remote Inhibit Mode.

No delay is allowed (CAL AND ID switch 7 OFF, down) and multiple MPS operation (CAL AND ID switch 4 ON, up) must be selected. After the load discharges, turn OFF all units to reset. The MPS displays the OVP error message.

Overvoltage Protection (OVP) Circuit Activated

If the voltage across the MPS output terminals rises above ± 40 volts, the output over voltage protection (OVP) circuit activates. The MPS also may activate the OVP circuit in response to faults. Upon activation, the OVP circuit uses thyristors to crowbar the output voltage to between 1 and 1.3 volts until magnet current reaches zero. If this occurs, change the output current setting to zero.

If the MPS detects OVP activity on power up (output current greater than ± 1 A), it turns ON the front panel Fault annunciator, closes FLT contacts, and sounds the alarm twice per second. When the MPS detects the fault, it closes the FLT contacts to indicate a fault, sounds the alarm once per second, and displays:

```

OVERVOLTAGE PROTECTION:  OUTPUT:
THE OUTPUT SETTINGS ARE  -  0.00 A
FORCED TO 0 A AND 1 V.   +  1.00 V
OVP IS ACTIVE UNTIL THE  OVP *LOC
OUTPUT CURRENT FALLS
BELOW 1 A.
    
```

When output current falls below 1 A, the MPS turns OFF the front panel Fault annunciator and alarm, and opens the FLT contacts. When the MPS detects no OVP activity, the Normal Display appears.

The MPS continues to display OVP and sounds the alarm until the user enters new output settings, then turns them OFF. This latching action informs the user of OVP activity. The MPS opens the FLT contacts upon detecting OVP inactivity.

Low AC (LO AC) Detected

If the AC line falls below 80% of the nominal line selected, the MPS enters AC Loss Mode. If this occurs on power up, the MPS turns off the front panel circuit breaker and displays:

```

LO AC INPUT  OUTPUT:
LINE FAULT:  -  0.00 A
              +  1.00 V
THE UNIT WILL BE TURNED
OFF TO AVOID DAMAGE.
VERIFY AC INPUT SETTING. LOAC *LOC
    
```

This indicates that the AC source does not match the line voltage listed on the rear panel.

Upon utility loss during normal operation of a single MPS with a charged load, the MPS disables utility input circuitry and uses the load as an energy source. It turns OFF the front panel Power annunciator and turns ON the front panel Fault annunciator. It closes the FLT contacts to indicate

a fault and sounds the alarm about once per second. The MPS sets output voltage compliance to the level required to maintain operation and continuously monitors output current. If the utility recovers, the MPS enters Remote Inhibit Mode and forces output settings to 0 amps and 1 volt. If the utility does not recover, the MPS activates the output OVP circuit and turns OFF the front panel circuit breaker when the output current drops below 10 amps. Upon power down, the MPS enters AC Loss Mode.

NOTE: A utility loss while the MPS returns energy from a charged load to the utility presents no hazard to personnel working on the utility circuit. The MPS is not a UPS. It uses the utility voltage wave form to draw energy from the utility with a sinusoidal current and return energy to the utility with a sinusoidal current. If there is no utility reference signal, the MPS disables utility input circuitry and uses the load for energy.

If utility loss occurs during normal operation in a multiple MPS configuration, the MPS detecting the utility loss initiates Multiple MPS Remote Inhibit Mode by closing the FLT contacts and turning off the front panel circuit breaker. Then the remaining MPS units enter Multiple MPS Remote Inhibit Mode.

High AC (HI AC) Detected

Any time the AC line rises above 120% of the nominal line selected, the MPS turns off the front panel circuit breaker and enters AC Loss Mode. This halts excessive utility voltages to internal circuitry. If this occurs on power up, the MPS turns off the front panel circuit breaker and displays:

```

HI AC INPUT  OUTPUT:
LINE FAULT:  -  0.00 A
              +  1.00 V
THE UNIT WILL BE TURNED
OFF TO AVOID DAMAGE.
VERIFY AC INPUT SETTING. HIAC *LOC
    
```

Overtemperature Detected

If the MPS detects internal over temperature or other internal fault, it activates the OVP circuit, turns off the front panel circuit breaker, and then turns itself off. OVP stays active until it completely discharges the load. If the heat sink temperature exceeds 95 °C (203 °F), the MPS displays:

```

INTERNAL     OUTPUT:
TEMP FAULT:  -  0.00 A
              +  1.00 V
THE UNIT WILL BE TURNED
OFF TO AVOID DAMAGE.
INTERNAL TEMP TOO HI.  TEMP *LOC
    
```

Rail Fault Detected

Excessive DC rail voltage (unable to return power to the utility or some other internal fault), causes the MPS to display:

```
INTERNAL      OUTPUT:
RAIL FAULT : - 0.00 A
              + 1.00 V
THE UNIT WILL BE TURNED
OFF TO AVOID DAMAGE.
DC RAIL VOLTAGE TOO HI. RAIL *LOC
```

I STEP Limit Exceeded

When the user attempts to change the current setting by more than the step limit setting, the MPS displays:

```
I STEP LIMIT EXCEEDED:  OUTPUT:
OUTPUT CURRENT CHANGED  - 0.00 A
MORE THAN THE I STEP    + 0.00 V
LIMIT IN ONE UPDATE.
THE OUTPUT SETTINGS ARE
FORCED TO 0 A AND 1 V.  STP *LOC
PRESS + TO CLEAR ERROR.
```

5.2 FACTORY DEFAULT SETTINGS

Below is a list of factory-presets. To reinitialize the MPS to factory presets, hold **Esc** for about 15 seconds.

Normal Display Screen

I SET: +0.00A – Current Setting
V SET: +1.00V – Voltage Setting

Setup Screen

IEEE / SIO: – IEEE/SIO Option Status (<NP> if not present)
CB DEF: 9600,0,7,1 – Control Bus Definition (9600 Baud, Odd Parity, 7 Data Bits, 1 Stop Bit)
CB ADD: 0 – Control Bus Address
VW ANGLE: 5 – Viewing Angle (5 = Straight On)
IMAX SET: + 72.00 A – Maximum Current Setting in Amps
VMAX SET: + 30.00 V – Maximum Voltage Setting in Volts

IEEE/SIO Setup Screen (If Present)

IEEE ADD: 12 – IEEE Address
TERMS: (CR LF) – Terminators Status (Carriage Return & Line Feed)
EOI: <ON> – EOI Status = On
BAUD: 1200 – Baud Rate for RS-232
DEF: 0,7,1 – SIO Definition (Odd Parity, 7 Data Bits, 1 Stop Bit)

Ramp Status Screen

SEGMENT: <OFF> – Ramp Segment = Off
STATUS: HOLDING – Ramp Status = Holding
FROM: + 0.00 A – Ramp From (in Amps)
TO: + 0.00 A – Ramp To (in Amps)
AT: + 0.00 A/Sec – Ramp At (in Amps per Second)

Field Measurement Screens (If Present)

READING: <OFF> – Reading Status = Off
UNITS: kG – Field Units in Kilogauss
mV/kG: + 0.800 – Field Probe Sensitivity
ZERO RDG: <OFF> – Field Probe Zero and Status = Off

Output Current Zero Screen

STATUS: <OFF> – Output Current Zero Status = Off
I ZERO: + 0.00 A – Output Current Zero Value
I MODE: INTERNAL – Output Current Programming Mode (Display Only)

Current Step Limit Screen

STATUS: <ON> – Output Current Step Limit Status = On
I STEP: + 10.00 A – Output Current Step Limit = +10.00 Amps

5.3 CALIBRATION

NOTE: Calibration is only as accurate as the current monitor shunt. The factory uses a current monitor shunt rated at 0.02% accuracy. Shunt manufacturers typically stock accuracy values of 0.25% or better. To use a different value, adjust the readings given in the procedure.

1. Equipment requirements for MPS calibration:
 - a. Current monitor shunt, 100 mV output at 100A (1 milliohm), 0.02% accurate.
 - b. Load resistor, 10V at 100A (0.1 ohm), 1 kW.
 - c. Digital Volt Meter (DVM) with a resolution of 100 nV, 6 1/2 digits, 0.0035% accurate (HP 3457A or equivalent).
 - d. A computer with a RS-232C serial interface.
 - e. LSCI Model 2002 RJ-11 to DB-25 adapter or Model 2003 RJ-11 to DE-9 adapter, depending on the computer serial output connector.
 2. Turn OFF and unplug the MPS before configuring it for calibration.
 3. Configure the Control Bus Serial Interface for RS-232C Operation. See Paragraph C4.0. Connect output to a computer using a modular cable, or if equipped, use the IEEE 6224 card.
 4. Connect current monitoring shunt and load resistor in series to +OUT and –OUT terminals.
 5. Enable MPS calibration. Locate rear panel CAL AND ID switches and turn ON (up) switch 8. Verify that both MODE switches in the INTernal (up) position.
 6. Plug the MPS in, turn it ON, and allow it to warm up for one hour.
- NOTE:** To terminate calibration at any time, send the CALDN command. Cycle MPS power to recover calibration constants present prior to calibration initiation.
- Calibration determines a zero, positive span, and negative span digital calibration constant for both current and voltage. Enter calibration constants with extreme caution. If a constant is entered incorrectly, terminate the calibration procedure with the CALDN command and re-start the sequence.
7. When calibrating current, the MPS forces ISET to the calibration current. When calibrating voltage, the MPS forces VSET to the calibration voltage and ISET to IMAX. Set IMAX to equal or greater than the calibration current. Input and note the IMAX value using the IMAX? command. For this calibration procedure, send IMAX+50 to set IMAX to 50. Turn OFF the output current step feature during calibration. Input and note the output current step status using the ISTPS? command. Send the ISTPS0 command to turn OFF output current step limiting.
 8. Connect the DVM reading voltage across the +OUT and –OUT terminals.
 9. Send the command 'VZER' to inform the MPS of output voltage calibration and force output voltage to 0V. Verify a DVM reading of 0V \pm 0.1V. Allow MPS output to settle for 2 minutes.
 10. Read actual output voltage from the DVM. Send the MPS the actual voltage using the command 'CALZ+xxx.xxxx'. If actual voltage is +0.0123 volts, send 'CALZ+0.0123'. The MPS determines the zero voltage calibration constant.
 11. Send 'VCAL5' to force output voltage to +5 volts. Verify that the DVM reads +5V \pm 10%. Allow MPS output to settle for 2 minutes.
 12. Read actual output voltage from the DVM. Send the actual voltage with the command 'CALPL+xxx.xxxx'. If actual voltage is +5.1234V, send 'CALPL+5.1234'. The MPS determines the positive voltage calibration constant.
 13. After the MPS determines the positive voltage calibration constant, it automatically sets output voltage to the same value with the opposite sign. Verify a DVM reading of -5V \pm 10%. Allow MPS output to settle for 2 minutes.
 14. Read actual output voltage from the DVM. Send the actual voltage with the command 'CALMN-xxx.xxxx'. If actual voltage is -4.8766V, send 'CALMN-4.8766'. The MPS determines the negative voltage calibration constant.
 15. The MPS stores the zero, positive, and negative voltage calibration constants, then sets the output voltage to 0. Verify a DVM reading of 0V \pm 0.1V before continuing the calibration.
 16. Connect the DVM across the current monitoring resistor.
 17. Send 'IZER' to force output current to 0 amps for output current calibration. Verify a DVM reading of 0V \pm 0.01V. Allow MPS output to settle for 2 minutes.
 18. Convert the DVM voltage reading to current. A reading of +0.000345V equals +0.345A. Send the actual current with the command 'CALZ+xxx.xxxx'. If the actual current is +0.345 amps, send 'CALZ+0.3450'. The MPS determines the zero current calibration constant.
 19. Send 'ICAL50' to inform the MPS of output current calibration and to force output current to +50 amps. Verify a DVM reading of +0.05V \pm 10%. Allow MPS output to settle for 2 minutes.

20. Convert DVM voltage reading to current. A reading of +0.512345V equals +51.2345A. Send actual current with 'CALPL+xxx.xxxx'. If actual current is +51.2345A, send 'CALPL+51.2345'. The MPS determines the positive current calibration constant.
21. After the MPS determines the positive current calibration constant, it automatically sets output current to the same value with the opposite sign. Verify that the DVM reads -0.05V \pm 10%. Allow MPS output to settle for 2 minutes.
22. Convert voltage read from the DVM to current. A reading of -0.0487655V equals -48.7655A. Send actual current with the command 'CALMN-xxx.xxxx'. If actual current is 48.7655A, send

'CALMN-48.7655'. The MPS determines the negative current calibration constant.

23. The MPS stores the zero, positive, and negative current calibration constants then sets output current to 0. Verify a DVM reading of 0V \pm 0.00005V before continuing the calibration.
24. Use IMAX and STPS commands to restore IMAX and output current step to Step 7 values.
25. Turn off MPS and disconnect calibration loads.
26. Restore original Control Bus Serial Interface settings.
27. Disable MPS calibration. Turn OFF (down) CAL AND ID switch 8.

4. Turn ON MPS. Initially, the display clears and the alarm sounds for a short time. Within two seconds, the Normal Display appears.

5.4 PERFORMANCE TEST

Performance tests verify proper MPS operation into a resistive load without testing all specified parameters. The tests include no troubleshooting information, but can provide information that may localize faults. If any tests fail, contact authorized service personnel.

WARNING: For service, return the MPS to Lake Shore or a factory representative. Lake Shore Cryotronics, Inc. cannot be held liable for injury or death of personnel attempting unauthorized MPS repairs.

Test Equipment Required

1. Current monitor shunt, 100 mV output, rated at 150 A. Manufacturers typically stock this shunt value. If a different value is used, adjust readings given in the procedure.
2. Digital Volt Meter (DVM) capable of reading DC voltage from 100 mV with 0.1 mV accuracy to 35 V with 0.1 V resolution.

Performance Test Procedure

The test procedure includes both front panel and remote operation. Execute the performance tests in the order given. Note any non-compliance.

Test Setup

1. Connect input power to the MPS as outlined in Sections 2.5 through 2.5.3 of this manual.
2. Disconnect any leads from MPS output terminals.
3. Set Programming Mode Switches on the MPS rear panel(s) to the INT (up) position. Set the CAL and ID switch 7 OFF (down).

Output Voltage Verification

5. From the MPS front panel, select the Instrument Setup (INSTR. SETUP) menu and change compliance voltage to 5 V. Press the Normal Display key to return to the Normal Display screen.
6. Set output current to +1 A. Use the DVM to read the voltage across the MPS unit(s) output terminals. The reading should be +5 V \pm 0.3 V.
7. Set output current to 1 A. The DVM should read 5 V \pm 0.3 V.
8. Turn OFF MPS.

Output Current Verification

9. Use AWG #4 wire to connect the current monitor shunt between the MPS +OUT and -OUT terminals. Connect DVM across the shunt monitoring terminals. Note DVM offset reading.
10. Turn ON MPS. Within two seconds, the Normal Display appears.
11. Select the Instrument Setup (INSTR. SETUP) menu and change compliance voltage to 2 Volts. Press the Normal Display key to return to the Normal Display screen.
12. Wait 1 minute for MPS output to settle. The DVM should read the same as recorded for Step 9 \pm 0.01 mV.
13. Set output current to +50 Amps The DVM should read about +33 mV. After about 1 minute, the DVM should read +33.333 mV \pm 0.117 mV (not including offset from Step 9).

14. Set output current to +100 Amps. The DVM should read about +66 mV. After about 1 minute, the DVM should read +66.666 mV ± 0.233 mV (not including offset from Step 9).
15. Set output current to -50 Amps. The DVM should read about -33 mV. After about 1 minute, the DVM should read -33.333 mV ± 0.117 mV (not including the offset from Step 9).
16. Set output current to -100 A mps. The DVM should read about -66 mV. After 1 minute, the DVM should read -66.666 mV ± 0.233 mV (not including the offset from Step 9).

17. Set output current to 0 A.

Fault/RI Operation Verification

18. Short the MPS RI input with a shorting jumper. MPS output current should drop to 0 A, and the alarm should sound about once per second. Verify the MPS displays the RI screen shown in Paragraph 3.7.1.
19. With the unit ON, disconnect AC power connector. The front panel circuit breaker should trip.
20. The performance verification is complete.

5.5 REAR PANEL CONNECTOR DETAILS

Figure 5-1 MPS Rear Panel Connectors

Table 5-1 Rear Panel Connector Definitions

| TERMINAL | LABEL | DEFINITION |
|----------|---------------|---|
| 1 2 | RI+ RI- | Remote Inhibit – Active low, TTL-compatible input to remotely disable the output (force the output settings to 0 A and 1 V). |
| 3 4 | FLT + FLT- | Fault Indicator – Normally open contact closure to indicate a fault condition has occurred. Contact rating: 0.25 A resistive at 100 VDC, 3 W, 25 VA. |
| 5 6 | ON+ ON- | ON Indicator – Contact closure to indicate when the front panel circuit breaker is in the ON position. Contact rating: 0.25 A resistive at 100 VDC, 3 W, 25 VA. |
| 7 | Reserved | None |
| 8 | OVP | Overvoltage Protection Enable – Analog signal connected in parallel to other MPS Units to remotely activate the output overvoltage protection circuit. |
| 9 | Im | Output Current Monitor – Voltage output from Im to GND(M) is ± 0.01 V/A. |
| 10 | Vm | Output voltage monitor – Voltage output from Vm to GND(M) is ± 0.01 V/V. |
| 11 | m | Monitor and program ground. GND(M). |
| 12 | Vp | Factory Use Only |
| 13 | +Vs | Factory Use Only |
| 14 | -Is | Enable external output current programming via MODE switch. |
| 15 | Ip | Voltage input from Ip to GND(M) is ± 0.01 V/A. |
| 16 | +Is | A 10 k Ω potentiometer from +Is to -Is with center tap to Ip produces the minimum voltage for full scale current output (± 1.25 V for Model 622 or ± 1.55 V for Model 623). Voltage applied to Ip sums with internal current programming voltage. |
| 17 18 | -S +S | Remote voltage sense correction. Correction for load lead drops of up to 0.5 V per lead. |

Figure 5-2 Serial Interface Connector

Table 5-2 Serial Interface Connector Definition

| PIN | RS-232C FUNCTION | RS-485 FUNCTION |
|-----|------------------|-----------------|
| 1 | No Function | No Connection |
| 2 | Receive Data | A |
| 3 | Signal Ground | No Connection |
| 4 | Signal Ground | No Connection |
| 5 | Transmit Data | B |
| 6 | No Connection | No Connection |

5.6 IEEE-488 INTERFACE CONNECTOR

(When Model 6224 Option Is Present)

Connect to the rear MPS IEEE-488 Interface connector with cables specified in the IEEE-488-1978 standard document. The cable has 24 conductors with an outer shield. The connectors at each end are 24-way Amphenol 57 Series (or equivalent) with piggyback receptacles to daisy-chain multiple devices. Secure the connectors in the receptacles by a pair of captive locking screws with metric threads.

The total length of cable allowed in a system is 2 meters for each device on the bus, or 20 meters total for a maximum of 15 devices. The figure below and the table to the right shows the IEEE-488 Interface connector pin location and signal names.

| PIN | SYMBOL | DESCRIPTION |
|-----|--------|--------------------------------------|
| 1 | DIO1 | Data Input/Output Line 1 |
| 2 | DIO2 | Data Input/Output Line 2 |
| 3 | DIO3 | Data Input/Output Line 3 |
| 4 | DIO4 | Data Input/Output Line 4 |
| 5 | EOI | End Or Identify |
| 6 | DAV | Data Valid |
| 7 | NRFD | Not Ready For Data |
| 8 | NDAC | Not Data Accepted |
| 9 | IFC | Interface Clear |
| 10 | SRQ | Service Request |
| 11 | ATN | Attention |
| 12 | SHIELD | Cable Shield |
| 13 | DIO5 | Data Input/Output Line 5 |
| 14 | DIO6 | Data Input/Output Line 6 |
| 15 | DIO7 | Data Input/Output Line 7 |
| 16 | DIO8 | Data Input/Output Line 8 |
| 17 | REN | Remote Enable |
| 18 | GND 6 | Ground Wire – Twisted pair with DAV |
| 19 | GND 7 | Ground Wire – Twisted pair with NRFD |
| 20 | GND 8 | Ground Wire – Twisted pair with NDAC |
| 21 | GND 9 | Ground Wire – Twisted pair with IFC |
| 22 | GND 10 | Ground Wire – Twisted pair with SRQ |
| 23 | GND 11 | Ground Wire – Twisted pair with ATN |
| 24 | GND | Logic Ground |

Figure 5-3 IEEE-488 Interface Connector

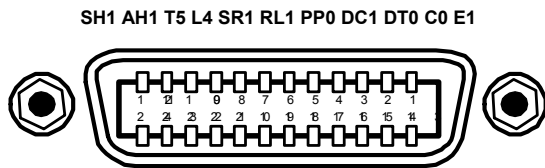

5.7 SERIAL INTERFACE CABLE AND ADAPTERS

To aid in Serial Interface troubleshooting, the figures below provide wiring information for the cable assembly and the two mating adapters.

Figure 5-4 Model 2001 RJ-11 Cable Assembly Wiring

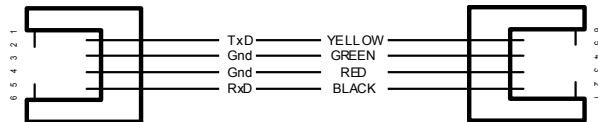

Figure 5-5 Model 2002 RJ-11 to DB-9 Adapter Wiring

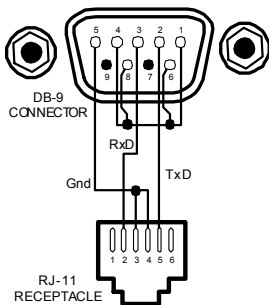
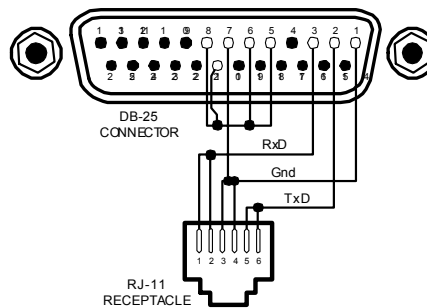

Figure 5-6 Model 2003 RJ-11 to DB-25 Adapter Wiring



● = Not Used

This Page Intentionally Left Blank

CHAPTER 6

OPTIONS AND ACCESSORIES

6.0 GENERAL

This chapter covers Model 647 MPS options and accessories: Model 6224 IEEE-488/Serial Interface (Paragraph 6.1), Model 6476 Gaussmeter Input Card (Paragraph 6.2), Model 6477 High Resolution Display and Programming Option (Paragraph 6.3), and Accessories (Paragraph 6.4).

6.1 MODEL 6224 IEEE-488/SERIAL INTERFACE

This option interfaces with a Customer-supplied computer equipped with a compatible IEEE-488 or Serial Interface. It accesses operating data and stored parameters and remotely controls front panel operations. Only one Model 6224 is required for multiple MPS installations. See Chapter 4 for MPS remote operation.

Installation Procedure

WARNING

- **This procedure is intended for trained service personnel who understand electronic circuitry and the hazards involved. Do not attempt this procedure unless qualified.**
- **To prevent shock hazard, turn off the instrument and disconnect AC line power and all test equipment before proceeding.**

1. Turn unit OFF and disconnect power cord.
2. Remove the two screws of the blank option cover plate to the far left of the MPS rear panel and remove the cover plate. If another option exists in this slot, remove it. The IEEE cable should point down. Install the option in the far slot to avoid IEEE cable interference with the power cord.
3. Slide the Model 6224 board into the MPS with the board handle towards the bottom of the MPS. Tighten the two screws that secure the board to the MPS rear panel.
4. (If Required) Install the option removed from the Model 6224 slot into a different slot.
5. Set the IEEE-488 operating parameters as outlined in Paragraph 4.1.1 and the Serial Interface as outlined in Paragraph 4.2.2.

6.2 MODEL 6476 GAUSSMETER INPUT CARD

This option provides quantitative magnetic field monitoring. Each input has independent excitation. Display the field in kilogauss or tesla. Field interfacing supports Hall sensors and includes probe zero and entry of probe sensitivity in millivolts per kilogauss. Below are specifications for the Model 6476 Gaussmeter Input Card:

Cryogenic Hall Sensor Type: Lake Shore Model HGCT-3020 (transverse) or Model HGCA-3020 (axial)

Number of Inputs: 1 four-lead measurement

Nominal Excitation Current: 100 mA

Display Resolution: 0.01 kG, 0.001 tesla

Probe Magnetic Sensitivity: 0.8 mV/kG \pm 30%

Electronic Accuracy: 1% of full scale

Nominal Field Range: Nominal \pm 125 kG (@ 0.8 mV/kG)

Input Voltage Resolution: > 0.01 mV out of 0.1 volts full scale

Sample Interval: Probe excited continuously & read when level is not

Contact Lake Shore for details on a variety of Hall Probes and Sensors.

6.2.1 Hall Sensor Mounting Considerations

The Lake Shore Model HGCT-3020 (Transverse) and Model HGCA-3020 (Axial) Cryogenic Hall Sensors are four terminal, solid state devices that produce output voltage proportional to the product of the input current, magnetic flux density, and the sine of the angle between the field vector and the plane of the Hall generator.

The active area of the Model HGCT-3020 Transverse Hall Sensor is approximately 0.04 inch in diameter with the center indicated by a cross on one face of the package. When the control current is applied with the red lead positive with respect to the black lead, and the magnetic field is perpendicular into the face of the probe with the cross on it, the Hall voltage will be positive at the blue lead with respect to the yellow lead. A reversal

in the mechanical orientation or in the direction of either the magnetic field or the control current will result in a polarity change of the output voltage.

The active area of the Model HGCA-3020 Axial Hall Sensor is approximately 0.03 inch in diameter in the center of the face opposite the leads. When the control current is applied with the red lead positive with respect to the black lead, and the magnetic field is perpendicular into the face of the probe opposite the leads, the Hall voltage is positive at the blue lead with respect to the yellow lead. Again, a reversal in mechanical orientation or in the direction of either the magnetic field or control current results in a output voltage polarity change.

Handle the Hall sensor with care. The ceramic substrate is brittle and very sensitive to bending stress. Mount the sensor to minimize mechanical strains as the sensor cools. Failure rates approaching 10% occur on initial cool down with improperly installed sensors (sensors surviving initial cool down generally experience no problems on subsequent cycles). Avoid applying tension to the leads. Bend the leads at any angle so long as the bend is at least 0.125 inch away from the substrate connection. Mount the device to a non-flexible, smooth surface with a coefficient of thermal expansion no greater than a factor of three different from that of the ceramic substrate (about 7×10^{-6} in/in per K).

Locate the probe in a cavity that is 0.003 inch wider and 0.01 inch longer than the substrate, and with a depth the same or slightly greater than the thickness of the package. Tack the leads outside the slot with GE-7031 varnish or other similar substance. Sparingly apply the mounting substance to the corners or a dot on each side of the sensor to hold it in place. Avoid applying mounting substance on top of the sensor. Alternately, use Kapton[®] tape or a mechanical cover over the top of the sensor to keep it in place. The tape or cover should apply only light pressure to the sensor. If epoxy is the mounting substance, use it sparingly and use the same type as is used in the sensor, Stycast[®] 2850-FT epoxy. Never pot the probe.

A room temperature calibration over the range of ± 30 kG comes with each probe. The calibration specifies the terminating resistor (not included) required to maintain an accuracy of $\pm 1\%$ of reading up to ± 30 kG and $\pm 2\%$ of reading up to ± 150 kG over the entire temperature range. For a terminating resistor, use a metal film resistor with 1% or better accuracy mounted across the output voltage leads as close to the probe as is practical. To extend the leads, use AWG 34 stranded copper with Teflon insulation (the same wire used on the probe). Any impedance in the output leads acts as a voltage divider with the terminating resistor. Probe reading reproducibility is within $\pm 1\%$ over repeated thermal cycling between 4.2 K and room temperature.

6.2.2 Connections

The Model 6476 has one rear panel 9-pin connector to interface with the level and field probes. See Table 6-1 to the right.

6.2.3 Installation

The 6476 Gaussmeter Input Option is factory-installed if ordered with a MPS or may be field installed at a later date. For field installation, use the procedure below:

WARNING

- **This procedure is intended for trained service personnel who understand electronic circuitry and the hazards involved. Do not attempt this procedure unless qualified.**
- **To prevent shock hazard, turn off the instrument and disconnect AC line power and all test equipment before removing cover.**

1. Turn off the MPS and disconnect the power cord.
2. Locate the Optional Plug-In Board Slots on the MPS rear panel. Loosen the two screws that secure one of the blank cover plates and remove the cover plate.
3. Slide the Model 6476 board into the MPS with the board handle towards the bottom of the MPS. Tighten the two screws that secure the board to the MPS rear panel.

| Terminal | Description |
|----------|----------------|
| 1 | Field -Current |
| 2 | Field -Voltage |
| 3 | Field +Voltage |
| 4 | Field +Current |
| 5 | Shield |
| 6 | Not Used |
| 7 | Not Used |
| 8 | Not Used |
| 9 | Not Used |

Table 6-1 Model 6476 Connections

6.2.4 Operation

To access field monitoring, press **Function Menu**, then **Next Menu**. Function Menu 2 displays. Press the **FIELD** Function key to display the Field Measurement screen. The Menu window returns to displaying the Output values.



The following are valid Field Measurement entries:

READING: <OFF> or <ON>

Field Reading Status.

CHANGE PROBE SETTING

Change Field Probe Settings. Press either of the Data Entry up or down keys to display the Field Probe Setting screen to the right.

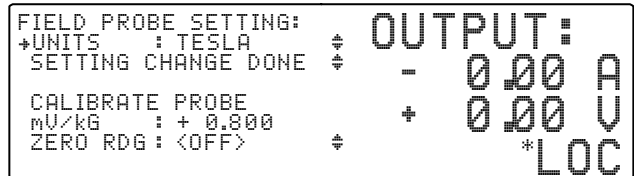

The cursor up and down keys move the line indicator (→). The up and down arrow icon indicates parameters that can only be changed using the Data Entry up and down arrows.

When there are <ON> or <OFF> indicators, the Data Entry up and down arrows change the status. The following are valid Field Probe Setting entries:

UNITS: T or kG

Field Units. The Up or down Numeric Entry keys scroll between the units: **T** (tesla) or **kG** (kilogauss). The default is **kG**.

SETTING CHANGE DONE

Field Probe Setting Change Done. The Up or down Numeric Entry keys exit the Field Probe Setting screen and return to the Field Measurement screen.

NOTE: The entries below change probe calibration. Do not change unless probe is actually being calibrated.

CALIBRATE PROBE:

mV/kG: +XXX.XXX

Field Probe Sensitivity. Each Hall Probe comes with a mV/kG sensitivity. Use any numeric entry mode to change the value from 0 to 999.999.

ZERO RDG: <OFF> or <ON>

Field Probe Zero Reading. Connect the Hall Probe and place it in zero magnetic field. Press a Data Entry up or down arrow key to zero the probe. The display changes to **<ON>** to indicate an active field probe zero reading. When the field probe zero is complete, the display returns to **<OFF>**.

6.2.5 Remote Operation Commands

Below is a list of IEEE-488 commands that control Model 6476 remote operation.

BFLD? Magnetic Field Query

Input: **BFLD?**

Returned: A number between ±999.9999.

Remarks: Returns nine characters plus up to two terminators.

BUNI Program Magnetic Field Units

Input: **BUNI [units]** where **[units]** = **kG** for kilogauss, or **T** for tesla (10 kilogauss).

Remarks: The initial status is kG. Verify there is a space between the command and units parameter.

BUNI? Magnetic Field Units Query
Input: **BUNI?**
Returned: Either **kG** for kilogauss or **T** for tesla (10 kilogauss).
Remarks: Returns two characters plus up to two terminators.

IBS? Magnetic Field Summary Query
Input: **IBS?**
Returned: **[IOUT], [BFLD], [STB]**
Remarks: Returns 23 characters plus up to two terminators.

6.3 MODEL 6477 HIGH RESOLUTION DISPLAY AND PROGRAMMING OPTION

This option increases the current and voltage setting, and monitoring resolution to 1 mA and 1 mV respectively. The standard display and programming resolution is 10 mA and 10 mV.

The standard current setting DAC (digital to analog converter) has a bipolar resolution of 15 bits. The smallest step change is 4 mA. The Model 6477 High Resolution current setting DAC has a bipolar resolution of 17 bits and improves step change resolution to 1 mA. The voltage setting, current and voltage monitoring go through the same type of resolution increase.

The factory must install this option prior to shipment; it cannot be field-installed. With the option installed, Setting and Output display resolution automatically expands to the 0.001 place. Remote interface operation does not change since remote resolution is already to the 0.0001 place. The increased resolution does not increase MPS stability or accuracy over the standard resolution. Specifications for the Model 6477 are:

Current Display and Programming Resolution: 1 mA

Voltage Display and Programming Resolution: 1 mV

RES? Resolution Query.
Input: **RES?**
Returned: Either **0** for low resolution or **1** for high resolution.
Remarks: Returns two characters plus up to two terminators.

6.4 ACCESSORIES

Accessories are devices that perform a secondary duty as an aid or refinement to the primary unit. Below are accessories for the Model 647 MPS:

| MODEL NUMBER | DESCRIPTION OF ACCESSORY |
|--------------|--|
| 106-720 | Terminal Block Mate, 18-Contact. |
| 106-726 | Detachable Power Connector. |
| 115-010 | Detachable 240 VAC Line Cord (Great Britain). |
| 115-011 | Detachable 120 VAC Line Cord (USA, Canada). |
| 115-012 | Detachable 220 VAC Line Cord (Europe, SA). |
| 2001 | RJ-11 Cable Assembly. Four-Wire Cable Assembly with RJ-11 plugs on each end. Used with RS-232C Interface. Cable is 14 feet (4.6 meters) long. See Figure 7-1. |
| 2002 | RJ-11 to DB-25 Adapter. Adapts RJ-11 receptacle to female DB-25 connector. Used to connect Model 647 to Serial Port on rear of Customer's computer. See Figure 7-2. |
| 2003 | RJ-11 to DE-9 Adapter. Adapts RJ-11 receptacle to female DE-9 connector. Used to connect Model 647 to Serial Port on rear of Customer's computer. See Figure 7-3. |
| 8072 | IEEE-488 Interface Cable. Cable is 3.4 feet (1 meter) in length. |
| MST-410 | Transverse Probe. Used in electromagnetic fields. This probe is the same as used with the Lake Shore Model 410 Gaussmeter. |
| MSA-410 | Axial Probe. Used in electromagnetic fields. This probe is the same as used with the Lake Shore Model 410 Gaussmeter. |
| MPEC-410-3 | Extension Cable. Used with the Model MST-410 and MSA-410 listed above. |
| HGCT-3020 | Hall Sensor, Magnetic Field, Cryogenic, Transverse. This is an individual transverse Hall sensor meant for use in cryogenic magnet applications. Refer to Paragraph 7.4.1. for mounting considerations. |
| HGCA-3020 | Hall Sensor, Magnetic Field, Cryogenic, Axial. This is an individual axial Hall sensor meant for use in cryogenic magnet applications. Refer to Paragraph 7.4.1. for mounting considerations. |
| MCT-3160-WN | Probe, Magnetic Field, Cryogenic, Transverse. This is a complete 60 inch long Probe Assembly using a Model HGCT-3020 Transverse Hall Sensor. |
| MCA-2560-WN | Probe, Magnetic Field, Cryogenic, Axial. This is a complete 60 inch long Probe Assembly using a Model HGCA-3020 Axial Hall Sensor. |
| — | Output Cable Set. Output cables are 4 AWG. Each cable is 12 feet (3 meters) long. |

This Page Intentionally Left Blank

APPENDIX A

UNITS FOR MAGNETIC PROPERTIES

| Conversion from CGS to SI Units | | | | |
|--|-------------------------------------|--------------------------------------|--|--|
| Quantity | Symbol | Gaussian & CGS emu ^a | Conversion Factor, C ^b | SI & Rationalized mks ^c |
| Magnetic flux density, Magnetic induction | B | gauss (G) ^d | 10 ⁻⁴ | tesla (T), Wb/m ² |
| Magnetic Flux | Φ | maxwell (Mx), G•cm ² | 10 ⁻⁸ | weber (Wb), volt second (V•s) |
| Magnetic potential difference, magnetomotive force | U, F | gilbert (Gb) | 10/4π | ampere (A) |
| Magnetic field strength, magnetizing force | H | oersted (Oe), ^e Gb/cm | 10 ³ /4π | A/m ^f |
| (Volume) magnetization ^g | M | emu/cm ^{3h} | 10 ³ | A/m |
| (Volume) magnetization | 4πM | G | 10 ³ /4π | A/m |
| Magnetic polarization, intensity of magnetization | J, I | emu/cm ³ | 4π x 10 ⁻⁴ | T, Wb/m ²ⁱ |
| (Mass) magnetization | σ, M | emu/g | $\frac{1}{4\pi \times 10^{-7}}$ | A•m ² /kg Wb•m/kg |
| Magnetic moment | m | emu, erg/G | 10 ⁻³ | A•m ² , joule per tesla (J/T) |
| Magnetic dipole moment | j | emu, erg/G | 4π x 10 ⁻¹⁰ | Wb•m ^l |
| (Volume) susceptibility | χ, κ | dimensionless emu/cm ³ | $(4\pi)^{-2} \times 10^{-7}$ | Henry per meter (H/m), Wb/(A•m) |
| (Mass) susceptibility | χ _p , κ _p | cm ³ /g, emu/g | $\frac{4\pi \times 10^{-3}}{(4\pi)^2 \times 10^{-10}}$ | m ³ /kg H•m ² /kg |
| (Molar) susceptibility | χ _{mol} , κ _{mol} | cm ³ /mol, emu/mol | $\frac{4\pi \times 10^{-6}}{(4\pi)^2 \times 10^{-13}}$ | m ³ /mol H•m ² /mol |
| Permeability | μ | dimensionless | 4π x 10 ⁻⁷ | H/m, Wb/(A•m) |
| Relative permeability ^j | μ _r | not defined | - | dimensionless |
| (Volume) energy density, energy product ^k | W | erg/cm ³ | 10 ⁻¹ | J/m ³ |
| Demagnetization factor | D, N | dimensionless | 1/4π | dimensionless |

NOTES:

- a. Gaussian units and cgs emu are the same for magnetic properties. The defining relation is $B = H + 4\pi M$.
- b. Multiply a number in Gaussian units by C to convert it to SI (e.g. $1 \text{ G} \times 10^{-4} \text{ T/G} = 10^{-4} \text{ T}$).
- c. SI (Système International d'Unités) has been adopted by the National Bureau of Standards. Where two conversion factors are given, the upper one is recognized under, or consistent with, SI and is based on the definition $B = \mu_0(H + M)$, where $\mu_0 = 4\pi \times 10^{-7} \text{ H/m}$. The lower one is not recognized under SI and is based on the definition $B = \mu_0 H + J$, where the symbol I is often used in place of J.
- d. $1 \text{ gauss} = 10^5 \text{ gamma } (\gamma)$.
- e. Both oersted and gauss are expressed as $\text{cm}^{-1/2} \cdot \text{g}^{1/2} \cdot \text{s}^{-1}$ in terms of base units.
- f. A/m was often expressed as "ampere-turn per meter" when used for magnetic field strength.
- g. Magnetic moment per unit volume.
- h. The designation "emu" is not a unit.
- i. Recognized under SI, even though based on the definition $B = \mu_0 H + J$. See footnote c.
- j. $\mu_r = \mu/\mu_0 = 1 + \chi$, all in SI. μ_r is equal to Gaussian μ .
- k. $B \cdot H$ and $\mu_0 M \cdot H$ have SI units J/m³, $M \cdot H$ and $B \cdot H/4\pi$ have Gaussian units erg/cm³.

R.B. Goldfarb and F.R. Fickett, U.S. Department of Commerce, National Bureau of Standards, Boulder, Colorado 80303, March 1985, NBS Special Publication 696. For sale by the Superintendent of Documents, U.S. Government Printing Office, Washington, D.C. 20402.

This Page Intentionally Left Blank

APPENDIX B

MAINFRAME CONTROL BUS OPERATION

B1.0 GENERAL

There are seven elements to the Model 647 Mainframe Control Bus operating instructions: Control Bus Serial Interface Specifications (Paragraph B2.0), Control Bus Serial Interface Connector (Paragraph B3.0), Control Bus Serial Interface Configuration (Paragraph B4.0), Selecting the Control Bus Serial Interface Address (Paragraph B5.0), Control Bus Serial Interface Operation (Paragraph B6.0), and a sample control bus serial interface program (Paragraph B7.0).

B2.0 CONTROL BUS SERIAL INTERFACE SPECIFICATIONS

The MPS Mainframe control bus serial interface may be configured either for RS-232C or RS-485. RS-232C is an unbalanced (single ended), non terminated line for short distances (typically less than 50 feet) where the host computer serial interface is dedicated to one MPS Mainframe. RS-485 is a balanced, terminated line for multidrop (party-line) configurations with up to 32 drivers and receivers sharing the same line for data transmission. Each interface instrument has a unique address and operates in a polled mode. Set the MPS Mainframe to respond to one of 32 addresses.

| Serial Interface Specification | Configured For RS-232C | Configured For RS-485 |
|--------------------------------|-----------------------------------|-----------------------|
| Transmission | Three Wire | Two Wire |
| Address Configuration | None | Polled 1-32 |
| Distance | 50 Feet | 4000 Feet |
| Connector | Dual RJ-11 Modular (phone) Jacks | |
| Timing Format | Asynchronous | |
| Transmission Rate | Half Duplex | |
| Baud Rate | 9600 | |
| Bits per Character | 1 Start, 7 Data, 1 Parity, 1 Stop | |
| Parity Type | Odd | |
| Data Interface Levels | Tx/Rx Using EIA Levels | |
| Terminator | LF (0AH) | |

B3.0 CONTROL BUS SERIAL INTERFACE CONNECTOR

The serial interface connectors use dual standard 6-wire RJ-11 modular (phone) jacks. The two connectors are in parallel and facilitate the RS-485 multidrop configuration. Lake Shore Model 2001 data cables, which maintain pin 1 polarity, simplify multiple Mainframe interconnection. Lake Shore offers the Model 2002 RJ-11 to DB-25 adapter and Model 2003 RJ-11 to DE-9 adapter to connect to the host computer.

| Pin | RS-232C Function | RS-485 Function |
|-----|------------------|-----------------|
| 1 | No Connection | No Connection |
| 2 | Receive Data | A |
| 3 | Signal Ground | No Connection |
| 4 | Signal Ground | No Connection |
| 5 | Transmit Data | B |
| 6 | No Connection | No Connection |

B4.0 CONTROL BUS SERIAL INTERFACE CONFIGURATION

Configure the control bus serial interface for either RS-232C or RS-485 communications with DIP switches on the Communications Processor Board (CMP). The CMP plugs into the Mainframe rear panel. The standard control bus serial interface configuration is RS-485. Use the procedure below to change or verify the serial interface configuration.

1. Turn off the Mainframe and unplug the power cord.
2. Loosen the two screws that secure the CMP to the rear panel and slide the CMP out.

3. Locate and configure the control bus serial interface DIP switches as defined in the table to the right. The DIP switches are just inside the CMP front panel. Switches 1-4 define the interface as RS-232C. Switches 5-8 define the interface as RS-485 multidrop. Switch 8 activates 100 Ω bus termination for long serial interface runs. For RS-485, terminate extremely long main lines at the furthest point from the host. Limit main line length to under 4000 feet and multiple short stub lines from the main line (Mainframe to Mainframe) to under 50 feet. A typical RS-485 configuration runs the main line from the host to one of the first Mainframe serial interface jacks; a Lake Shore 2001 cable plugs into the other first Mainframe serial interface jack to connect to the second Mainframe, and so on. Connect up to 32 Mainframes in this way. Terminate the last Mainframe only if it is a significant distance from the host. Assign unique addresses to multiple Mainframes on a RS-485 interface.

| CMP Configuration DIP Switch | RS-232C | Terminated RS-485 | Unterminated RS-485 |
|------------------------------|---------|-------------------|---------------------|
| 1 | Closed | Open | Open |
| 2 | Closed | Open | Open |
| 3 | Closed | Open | Open |
| 4 | Closed | Open | Open |
| 5 | Open | Closed | Closed |
| 6 | Open | Closed | Closed |
| 7 | Open | Closed | Closed |
| 8 | Open | Closed | Open |

4. Replace the CMP.

B5.0 SELECTING THE CONTROL BUS SERIAL INTERFACE ADDRESS

Multiple Mainframes on the RS-485 interface each have a unique address and operate in a polled mode. Set the MPS Mainframe to respond to one of 32 addresses. Prefix all commands sent to a Mainframe with the Mainframe address. A Mainframe query response includes the address prefix if the address is not 0. The receipt of the LF (0AH) terminator resynchronizes communications and alerts all Mainframes that the next character is an address. A Mainframe with address 0 responds to all commands on the interface. A Mainframe using RS-232C can be given a unique address as well, but RS-232C is not suited for multi-drop operation. Access the Control Bus serial interface address from the Interface Setup screen. Press the Function Menu key to display Function Menu 1. Press the key corresponding to INTERFACE SETUP to display the Interface Setup screen.

```

SETUP:
+IEEE/SOI :          ⚡
CB DEF   : 9600,0,7,1
CB ADD   : 0          ⚡
UW ANGLE : 5         ⚡
MF ID    : 647 (1)
IMAX SET : + 72.00 A
UMAX SET : + 32.00 U
                                *LOC
OUTPUT:
- 0.00 A
+ 0.00 U
    
```

CB ADD: 0 to 32

Control Bus Address. Use the cursor key to move to the line indicating CB ADD. Use the Up or down Numeric Entry keys to increment or decrement the Control Bus Address. The initial condition is 0. Range is 0 to 32.

B6.0 CONTROL BUS SERIAL INTERFACE OPERATION

The host computer initiates the serial interface link and transmits either a command or a query to the Mainframe. The Mainframe stores the characters in a buffer until the carriage return (CR), line feed (LF) terminator sequence. After receiving the terminators, the Mainframe responds appropriately to a query, if present, and stores the new input parameters.

Queries output requested data immediately following the processing of the command and terminator sequence. If more than one query is sent, the last query received is acknowledged. Commands and queries can be sent in the same command string. For example, the command string **ISET+10 VSET+10** updates the current setting to +10 amps and the voltage setting to +10 volts. No query was sent, therefore the Mainframe returns no response. The command string **ISET+10 VSET+10 ISET?** causes the Mainframe to return the current setting as well.

The serial interface shares device specific commands with the IEEE-488 interface. Tables B-1 and B-2 summarize the commands. See Chapter 3 of this manual for detailed command descriptions. The END and TERM remote commands are IEEE-488 interface specific commands not supported by the serial interface.

When programming a Mainframe from the serial interface, consider the notes below. See Chapter 3 for additional notes on commands.

- The control bus serial interface transmission mode (asynchronous half duplex), format (10 bits per character; 1 start, 7 data, 1 odd parity, and 1 stop), and baud rate (9600) are all fixed at the factory as outlined previously in the Serial Interface Specifications.
- The control bus cannot be used for remote interfacing if a Multiple Mainframe (MMF) configuration is used. In MMF mode, the Control Bus is used for Mainframe to Mainframe communications.
- End of string terminators are fixed at (CR)(LF).
- Add a query to the end of a command string if the Mainframe is required to return information.
- Chain commands together with a semi-colon, a comma, or a blank. Some programming languages do not allow separators other than a blank.
- At 9600 baud, each character takes about 1 millisecond to transmit. Some host computers DMA serial interface access. The program must allow for the transmission time delay before looking for a query response.
- Characters received by the Mainframe store in a buffer. After receiving the terminators, the Mainframe stores any new parameters and responds to the query (if requested). The Mainframe requires about 100 milliseconds to store new parameters before receiving any more new commands.
- The Mainframe implements new parameters and updates measurement data once per 500 millisecond operation cycle. Do not send new parameters or request data at a rate faster than 2 Hz.

B7.0 CONTROL BUS SERIAL INTERFACE SAMPLE PROGRAM

The following PC program is an interactive program that prompts the user for a Mainframe command and displays the Mainframe response. The command must include a query for the Mainframe to respond.

```
'This QuickBasic 4.0 program is for an IBM PC or compatible. Enter the
'Mainframe command at the prompt. The Mainframe response then displays.
'"END" exits the program.

COUNT = 1000
TERM$ = CHR$(13) + CHR(10)

OPEN "com1:9600,0,7,1,RS" FOR RANDOM AS #1 LEN = 256
L1: INPUT "ENTER COMMAND (END TO EXIT):", CMD$
CMD$ = UCASE$(CMD$)
IF CMD$ = "END" THEN CLOSE #1: END
PRINT #1, CMD$ + TERM$

IF INSTR(CMD$, "W") <> 0 OR INSTR(CMD$, "XD") <> 0 OR INSTR(CMD$, "?") <> 0 THEN
  RS$ = ""
  N = 0
  WHILE (N < COUNT) AND ((INSTR(RS$, TERM$) = 0) OR (RS$ = ""))
    R$ = INPUT$(LOC(1), #1)
    IF R$ = "" THEN N = N + 1 ELSE N = 0
    RS$ = RS$ + R$
  WEND
  IF RS$ <> "" THEN
    RS$ = MID$(RS$, 1, (INSTR(RS$, TERM$) - 1))
    PRINT "RESPONSE: "; RS$
  ELSE
    PRINT "NO RESPONSE"
  END IF
END IF
GOTO L1

END
```

Table B-1 MPS Mainframe Control Bus Remote Command Summary

| Input Command | Query | Function |
|--|-----------|--|
| *CLS | – | Clear all pending status. |
| *ESE | *ESE? | Event status register enable. |
| – | *ESR? | Event status register contents. |
| – | *IDN? | Product identification. |
| *SRE | *SRE? | Service request (status byte) enable. |
| – | *STB? | Status byte register contents. |
| – | *TST? | Self-test error status. |
| MODE | MODE? | IEEE interface mode status (not used). |
| TERM | TERM? | IEEE interface terminator status. Terminators fixed at (CR)(LF). |
| I, ISET | I?, ISET? | Output current setting. |
| V, VSET | V?, VSET? | Output compliance voltage setting. |
| – | IOUT? | Output current measurement. |
| – | VOUT? | Output voltage measurement. |
| – | ? | Output current, voltage, status byte, and programming mode. |
| IMAX | IMAX? | Maximum output current setting limit. |
| RAMP1 | RAMP? | Ramp segment parameter programming. |
| SEG | SEG? | Active ramp segment (fixed at 1). |
| RMP | RMP? | Ramp active enable and status. |
| VCAL ICAL CALPL CALMN VZER IZER CALZ | – | Mainframe digital calibration. |
| ZI | ZI? | Output current zero setting. |
| ZIS | ZIS? | Output current zero enable and status. |
| – | IMODE? | Current programming mode switch status. |
| – | VMODE? | Voltage programming mode switch status. |
| – | RES? | Normal or high resolution status. |
| – | OVP? | Output overvoltage protection status. |
| – | ERR? | Error Status. |
| – | RI? | Remote inhibit status. |
| ISTP | ISTP? | Output current step setting. |
| ISTPS | ISTPS? | Output current step enable and status. |
| STEPR1 | – | Output current step status reset. |

Table B-2 Additional MPS Mainframe Control Bus Remote Commands

| Input Command | Query | Function |
|------------------------------|-----------|--|
| – | ADR | Mainframe address. Multidrop address 0-32 available. Commands sent must have the address as the first character. Query response will be “00” thru “32.” |
| LOC LOCK UNLOCK REM | CMD | Mainframe Programming Status. Query response will be the same as what is programmed. There is no real change in Mainframe status. MPS equivalent commands are: LOC UNLOCK MODE0 MODE0 LOCK REM MODE2 MODE1 |
| – | ERRC | Mainframe Operational Status. Query response is status byte register contents, comma, standard event status register contents (equivalent to *STB? and *ESR? queries). Form of the response is XXX,XXX where XXX ranges from 000 to 255. *SRE and *ESE are forced to 255 to get a status response. |
| – | S1 | Mainframe Error Status. Query response is equivalent to ERR?. |
| WA | RA | Output Current Setting. MPS equivalent commands are: WA ISET ISET? RA |
| PO | OP | Output Current Polarity Setting and Status. |
| – | AD1, AD8 | Output Current Measurement. MPS equivalent command: IOUT? |
| – | AD2 | Output Voltage Measurement. MPS equivalent command: VOUT? |
| – | AD3 – AD7 | Internal Control Voltages. Query response forced to 000 until required responses are defined. |
| BAUD | – | Communications Baud Rate (Not Supported). Fixed at 9600. |
| N | – | Turn Mainframe Power ON (Not Supported). |
| F | – | Turn Mainframe Power OFF (Not Supported). |
| RS | – | Reset Mainframe Faults. (Only action taken is I Step Reset.) |