



Tate Lab Lakeshore 340; SN 343843
 Dual Input A & B Pt resistance thermometers
 Dual Input TC Model 3464; SN 334A021

User's Manual

Model 340

Temperature Controller

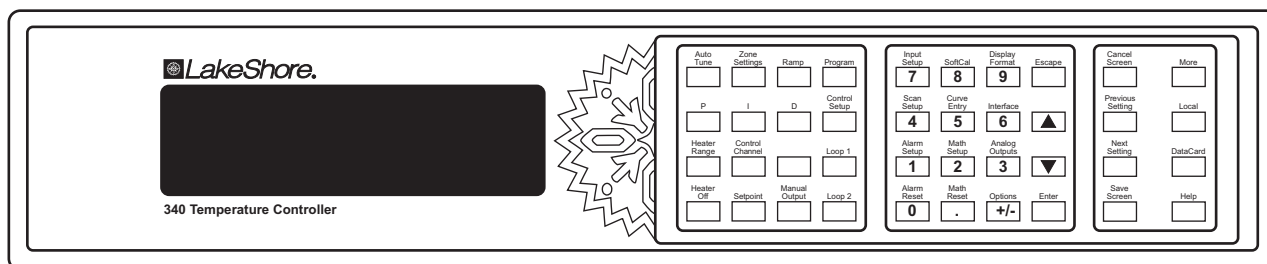

Lake Shore Cryotronics, Inc.
 575 McCorkle Blvd.
 Westerville, Ohio 43082-8888 USA

Internet Addresses:
sales@lakeshore.com
service@lakeshore.com

Visit Our Website:
www.lakeshore.com

Fax: (614) 891-1392
 Telephone: (614) 891-2243

Methods and apparatus disclosed and described herein have been developed solely on company funds of Lake Shore Cryotronics, Inc. No government or other contractual support or relationship whatsoever has existed which in any way affects or mitigates proprietary rights of Lake Shore Cryotronics, Inc. in these developments. Methods and apparatus disclosed herein may be subject to U.S. Patents existing or applied for. Lake Shore Cryotronics, Inc. reserves the right to add, improve, modify, or withdraw functions, design modifications, or products at any time without notice. Lake Shore shall not be liable for errors contained herein or for incidental or consequential damages in connection with furnishing, performance, or use of this material.

LIMITED WARRANTY STATEMENT

WARRANTY PERIOD: ONE (1) YEAR

1. Lake Shore warrants that this Lake Shore product (the "Product") will be free from defects in materials and workmanship for the Warranty Period specified above (the "Warranty Period"). If Lake Shore receives notice of any such defects during the Warranty Period and the Product is shipped freight prepaid, Lake Shore will, at its option, either repair or replace the Product if it is so defective without charge to the owner for parts, service labor or associated customary return shipping cost. Any such replacement for the Product may be either new or equivalent in performance to new. Replacement or repaired parts will be warranted for only the unexpired portion of the original warranty or 90 days (whichever is greater).
2. Lake Shore warrants the Product only if it has been sold by an authorized Lake Shore employee, sales representative, dealer or original equipment manufacturer (OEM).
3. The Product may contain remanufactured parts equivalent to new in performance or may have been subject to incidental use.
4. The Warranty Period begins on the date of delivery of the Product or later on the date of installation of the Product if the Product is installed by Lake Shore, provided that if you schedule or delay the Lake Shore installation for more than 30 days after delivery the Warranty Period begins on the 31st day after delivery.
5. This limited warranty does not apply to defects in the Product resulting from (a) improper or inadequate maintenance, repair or calibration, (b) fuses, software and non-rechargeable batteries, (c) software, interfacing, parts or other supplies not furnished by Lake Shore, (d) unauthorized modification or misuse, (e) operation outside of the published specifications or (f) improper site preparation or maintenance.
6. TO THE EXTENT ALLOWED BY APPLICABLE LAW, THE ABOVE WARRANTIES ARE EXCLUSIVE AND NO OTHER WARRANTY OR CONDITION, WHETHER WRITTEN OR ORAL, IS EXPRESSED OR IMPLIED. LAKE SHORE SPECIFICALLY DISCLAIMS ANY IMPLIED WARRANTIES OR CONDITIONS OF MERCHANTABILITY, SATISFACTORY QUALITY AND/OR FITNESS FOR A PARTICULAR PURPOSE WITH RESPECT TO THE PRODUCT. Some countries, states or provinces do not allow limitations on an implied warranty, so the above limitation or exclusion might not apply to you. This warranty gives you specific legal rights and you might also have other rights that vary from country to country, state to state or province to province.
7. TO THE EXTENT ALLOWED BY APPLICABLE LAW, THE REMEDIES IN THIS WARRANTY STATEMENT ARE YOUR SOLE AND EXCLUSIVE REMEDIES.
8. EXCEPT TO THE EXTENT PROHIBITED BY APPLICABLE LAW, IN NO EVENT WILL LAKE SHORE OR ANY OF ITS SUBSIDIARIES, AFFILIATES OR SUPPLIERS BE LIABLE FOR DIRECT, SPECIAL, INCIDENTAL, CONSEQUENTIAL OR OTHER DAMAGES (INCLUDING LOST PROFIT, LOST DATA OR DOWNTIME COSTS) ARISING OUT OF THE USE, INABILITY TO USE OR RESULT OF USE OF THE PRODUCT, WHETHER BASED IN WARRANTY, CONTRACT, TORT OR OTHER LEGAL THEORY, AND WHETHER OR NOT LAKE SHORE HAS BEEN ADVISED OF THE POSSIBILITY OF SUCH DAMAGES. Your use of the Product is entirely at your own risk. Some countries, states and provinces do not allow the exclusion of liability for incidental or consequential damages, so the above limitation may not apply to you.

LIMITED WARRANTY STATEMENT (Continued)

9. EXCEPT TO THE EXTENT ALLOWED BY APPLICABLE LAW, THE TERMS OF THIS LIMITED WARRANTY STATEMENT DO NOT EXCLUDE, RESTRICT OR MODIFY, AND ARE IN ADDITION TO, THE MANDATORY STATUTORY RIGHTS APPLICABLE TO THE SALE OF THE PRODUCT TO YOU.

CERTIFICATION

Lake Shore certifies that this product has been inspected and tested in accordance with its published specifications and that this product met its published specifications at the time of shipment. The accuracy and calibration of this product at the time of shipment are traceable to the United States National Institute of Standards and Technology (NIST); formerly known as the National Bureau of Standards (NBS).

FIRMWARE LIMITATIONS

Lake Shore has worked to ensure that the Model 340 firmware is as free of errors as possible, and that the results you obtain from the instrument are accurate and reliable. However, as with any computer-based software, the possibility of errors exists.

In any important research, as when using any laboratory equipment, results should be carefully examined and rechecked before final conclusions are drawn. Neither Lake Shore nor anyone else involved in the creation or production of this firmware can pay for loss of time, inconvenience, loss of use of the product, or property damage caused by this product or its failure to work, or any other incidental or consequential damages. Use of our product implies that you understand the Lake Shore license agreement and statement of limited warranty.

FIRMWARE LICENSE AGREEMENT

The firmware in this instrument is protected by United States copyright law and international treaty provisions. To maintain the warranty, the code contained in the firmware must not be modified. Any changes made to the code is at the user's risk. Lake Shore will assume no responsibility for damage or errors incurred as result of any changes made to the firmware.

Under the terms of this agreement you may only use the Model 340 firmware as physically installed in the instrument. Archival copies are strictly forbidden. You may not decompile, disassemble, or reverse engineer the firmware. If you suspect there are problems with the firmware, return the instrument to Lake Shore for repair under the terms of the Limited Warranty specified above. Any unauthorized duplication or use of the Model 340 firmware in whole or in part, in print, or in any other storage and retrieval system is forbidden.

TRADEMARK ACKNOWLEDGMENT

Many manufacturers and sellers claim designations used to distinguish their products as trademarks. Where those designations appear in this manual and Lake Shore was aware of a trademark claim, they appear with initial capital letters and the TM or [®] symbol.

Apiezon[®] is a trademark of Biddle Instruments.

CalCurve[™], Carbon-Glass[™], Cernox[™], DriftTrak[™], Duo-Twist[™], Quad-Lead[™], Quad-Twist[™], Rox[™], SoftCal[™], and Thermox[™] are trademarks of Lake Shore Cryotronics, Inc.

Chromel[™] and Alumel[™] are trademarks of Hoskins Manufacturing Company.

Formvar[™] is a trademark of Monsanto Chemical Company.

MS-DOS[®] and Windows[®] are trademarks of Microsoft Corporation.

NI-488.2[™] is a trademark of National Instruments.

PC, XT, AT, and PS-2 are trademarks of IBM.

Stycast[®] is a trademark of Emerson & Cuming.

Teflon[®] is a trademark of DuPont De Nemours.

Copyright ©1996 – 2001 and 2003 – 2009 by Lake Shore Cryotronics, Inc. All rights reserved. No portion of this manual may be reproduced, stored in a retrieval system, or transmitted, in any form or by any means, electronic, mechanical, photocopying, recording, or otherwise, without the express written permission of Lake Shore.



Declaration of Conformity

We: **Lake Shore Cryotronics, Inc.**
575 McCorkle Blvd.
Westerville, OH 43082-8888 USA

hereby declare that the equipment specified conforms to the following Directives and Standards:

Application of Council directives: **73/23/EEC**
89/336/EEC

Standard to which Conformity is declared:..... **EN 61010-1:2001**
Overvoltage II
Pollution Degree 2
EN 61326 A2:2001
Class A
Annex B

Model Number:..... **340**

1-7-2004

Signature

Date

Ed Maloof
Printed Name

Vice President of Engineering
Position

This Page Intentionally Left Blank

TABLE OF CONTENTS

<i>Chapter/Paragraph</i>	<i>Title</i>	<i>Page</i>
1	Introduction	1-1
1.0	Product Description	1-1
1.1	Sensor Inputs.....	1-1
1.2	Temperature Control	1-2
1.3	Interface.....	1-2
1.4	Configurable Display	1-3
1.5	Additional Inputs Available For Model 340	1-3
1.5.1	3462 Dual Standard Input Option Card	1-3
1.5.2	3464 Dual Thermocouple Input Option Card	1-3
1.5.3	3465 Single Capacitance Input Option Card	1-3
1.5.4	3468 Eight Channel Input Option Card	1-4
1.6	Sensor Selection	1-4
1.7	Specifications	1-7
1.7.1	Thermometry	1-7
1.7.2	Control	1-8
1.7.3	Front Panel	1-9
1.7.4	Interfaces	1-9
1.7.5	General	1-10
1.7.6	Product Configuration	1-10
2	Cooling System Design	2-1
2.0	General	2-1
2.1	Temperature Sensor Selection	2-1
2.1.1	Temperature Range	2-1
2.1.2	Sensor Sensitivity	2-1
2.1.3	Environmental Conditions	2-2
2.1.4	Measurement Accuracy	2-2
2.1.5	Sensor Package	2-2
2.2	Calibrated Sensors	2-2
2.2.1	Traditional Calibration	2-2
2.2.2	SoftCal™	2-3
2.2.3	Standard Curves	2-4
2.2.4	CalCurve™	2-4
2.3	Sensor Installation	2-4
2.3.1	Mounting Materials	2-4
2.3.2	Sensor Location	2-4
2.3.3	Thermal Conductivity	2-5
2.3.4	Contact Area	2-5
2.3.5	Contact Pressure	2-5
2.3.6	Lead Wire	2-6
2.3.7	Lead Soldering	2-6
2.3.8	Heat Sinking Leads	2-6
2.3.9	Thermal Radiation	2-6
2.4	Heater Selection and Installation	2-6
2.4.1	Heater Resistance and Power	2-6
2.4.2	Heater Location	2-7
2.4.3	Heater Types	2-7
2.4.4	Heater Wiring	2-7
2.5	Considerations for Good Control	2-7
2.5.1	Thermal Conductivity	2-7
2.5.2	Thermal Lag	2-8
2.5.3	Two-Sensor Approach	2-8
2.5.4	Thermal Mass	2-8

2.5.5	System Nonlinearity	2-8
2.6	PID Control	2-9
2.6.1	Proportional (P)	2-9
2.6.2	Integral (I)	2-9
2.6.3	Derivative (D)	2-9
2.6.4	Manual Heater Output (MHP).....	2-11
2.7	Manual Tuning	2-11
2.7.1	Setting Heater Range	2-11
2.7.2	Tuning Proportional	2-11
2.7.3	Tuning Integral	2-12
2.7.4	Tuning Derivative	2-12
2.8	AutoTuning	2-13
2.9	Zone Tuning	2-14
3	Installation	3-1
3.0	General	3-1
3.1	Receiving the Model 340	3-1
3.1.1	Inspection and Unpacking	3-1
3.1.2	Repackaging For Shipment.....	3-1
3.1.3	Safety Summary	3-2
3.1.4	Safety Symbols	3-2
3.1.5	Handling Liquid Helium and Liquid Nitrogen	3-3
3.1.5.1	Properties.....	3-3
3.1.5.2	Handling Cryogenic Storage Dewars	3-3
3.1.5.3	Liquid Helium and Nitrogen Safety Precautions	3-3
3.1.5.4	Recommended First Aid	3-4
3.2	Rear Panel Definition	3-4
3.3	Line Input Assembly	3-5
3.3.1	Line Voltage	3-5
3.3.2	Line Fuse and Fuse Holder	3-6
3.3.3	Power Cord	3-6
3.3.4	Power Switch	3-6
3.4	Standard Sensor Inputs	3-6
3.4.1	Sensor Input Connector and Pinout	3-6
3.4.2	Sensor Lead Cable	3-6
3.4.3	Grounding and Shielding Sensor Leads	3-7
3.4.4	Sensor Polarity	3-7
3.4.5	Four-Lead Sensor Measurement	3-7
3.4.6	Two-Lead Sensor Measurement	3-7
3.4.7	Lowering Measurement Noise	3-8
3.5	Heater Output Setup	3-8
3.5.1	Loop 1 Output	3-8
3.5.2	Heater Output Connector for Loop 1	3-8
3.5.3	Heater Output Wiring for Loop 1	3-8
3.5.4	Heater Protection and Fuse for Loop 1	3-9
3.5.5	Loop 1 Heater Noise	3-9
3.5.6	Model 3003 Heater Output Conditioner	3-9
3.5.7	Loop 2 Output	3-10
3.5.8	Loop 2 Output Resistance	3-10
3.5.9	Loop 2 Output Connector	3-10
3.5.10	Loop 2 Heater Protection	3-10
3.5.11	Boosting the Output Power	3-10
3.6	Analog Outputs	3-11
3.7	Digital I/O	3-12
3.8	Relays	3-12
4	Front Panel Operation	4-1
4.0	General	4-1

4.1	Turning Power On	4-1
4.2	Display Formats	4-1
4.2.1	Normal Display	4-2
4.2.2	Setting Displays	4-2
4.2.3	Data Entry Displays	4-2
4.2.4	Error Displays	4-2
4.3	Keypad Description	4-2
4.4	Keypad Navigation	4-3
4.4.1	Changing Parameters	4-3
4.4.2	Direct Settings	4-3
4.4.3	Using Setting Screens	4-4
4.4.4	Data Entry Screens	4-4
4.4.5	The Help Key	4-4
4.4.6	Keypad Time-out	4-4
4.4.7	Key Definitions	4-5
4.5	Changing Display Format	4-6
4.5.1	Number of Readings Displayed	4-6
4.5.2	Sensor Input	4-6
4.5.3	Reading Source and Display Units	4-7
4.5.4	Control Loop Display	4-7
4.5.5	Large Heater Display	4-7
4.5.6	Heater Output Display Units	4-8
4.5.7	Display Contrast	4-8
4.5.8	Display Backlight On/Off	4-8
4.5.9	Locking the Keypad	4-8
4.6	Default Values	4-8
5	Sensor Input and Temperature Measurement Operation	5-1
5.0	General	5-1
5.1	Sensor Input Setup	5-1
5.1.1	Sensor Type	5-1
5.1.2	Voltage Excitation (Current Autorange)	5-2
5.1.3	Thermal EMF Compensation with Voltage Excitation	5-2
5.1.4	Special Sensor Type Configuration	5-2
5.1.5	Turning an Input Off	5-3
5.2	Selecting a Temperature Response Curve	5-3
5.3	Filter and Math	5-4
5.3.1	Filter	5-4
5.3.2	Max/Min	5-5
5.3.3	Linear Equation	5-6
5.4	Scanner Support	5-6
5.4.1	Scan Modes	5-6
5.4.2	Input Setup with a Scan Mode Active	5-7
5.4.3	Manual Scanning	5-7
5.4.4	Auto Scanning	5-8
5.4.5	Slave Scanning	5-8
6	Temperature Control Operation	6-1
6.0	General	6-1
6.1	Control Loop Displays	6-1
6.1.1	Control Loops on the Normal Display	6-1
6.1.2	Loop Indication on the Normal Display	6-1
6.1.3	Loop Indication on Setting Screens	6-1
6.1.4	Control Output Display	6-2
6.2	Control Loop Enable	6-2
6.3	Control Loop Filter	6-2
6.4	Control Channel	6-3
6.5	Control Modes	6-3

6.6	Manual Setting of PID Control Parameters	6-4
6.6.1	Proportional (P)	6-4
6.6.2	Integral (I)	6-4
6.6.3	Derivative (D)	6-4
6.6.4	Manual Output	6-4
6.7	Selecting an AutoTune Control Mode	6-4
6.8	Zone Control Data Entry	6-5
6.9	Using Open Loop Control	6-7
6.10	Setting a Setpoint and Setpoint Units	6-7
6.11	Setpoint Ramping	6-8
6.12	Control Output	6-8
6.12.1	Heater Output Parameter Settings and Heater Range	6-8
6.12.2	Analog Output As Loop 2 Control Output	6-10
6.13	Control Output Limits	6-11
6.13.1	Setpoint Limit	6-11
6.13.2	Control Output Slope Limit	6-11
6.13.3	Heater Range Limit	6-11
7	Analog Output, Digital I/O, Alarm, And Relay Operation	7-1
7.0	General	7-1
7.1	Analog Outputs	7-1
7.1.1	Input Mode for Analog Output	7-2
7.1.2	Example of Low and High Parameter Setting	7-2
7.1.3	Loop 2 Mode for Analog Output 2	7-2
7.1.4	Manual Mode Operation of the Analog Outputs	7-3
7.2	Digital Inputs and Outputs (I/O)	7-3
7.2.1	Digital Output Modes	7-3
7.2.2	Digital Outputs in Alarm Mode	7-3
7.2.3	Digital Outputs in Scanner Mode	7-3
7.2.4	Digital Outputs in Manual Mode	7-4
7.2.5	Digital Input Modes	7-4
7.3	Input Alarms	7-4
7.3.1	Enabling an Input Alarm	7-4
7.3.2	Selecting an Input Alarm Source	7-5
7.3.3	Input Alarm High and Low Settings	7-5
7.3.4	Input Alarm Latching	7-5
7.3.5	Input Alarm Relay Setup	7-5
7.3.6	Input Alarm Reset	7-6
7.3.7	Audible Beeper	7-6
7.4	High and Low Relays	7-6
7.4.1	Selecting a Relay Mode	7-6
7.4.2	Manually Setting a Relay	7-6
8	Instrument Programming	8-1
8.0	General	8-1
8.1	Curve Entry From The Front Panel	8-1
8.1.1	Curve Numbers and Storage	8-1
8.1.2	Front Panel Curve Entry Operations	8-1
8.1.3	Front Panel Curve Edit	8-2
8.1.4	Front Panel Curve Copy	8-3
8.1.5	Front Panel Curve Erase	8-3
8.2	SoftCal™	8-4
8.2.1	SoftCal and Silicon Diode Sensors	8-4
8.2.2	SoftCal Accuracy with Silicon Diode Sensors	8-5
8.2.3	SoftCal and Platinum Sensors	8-5
8.2.4	SoftCal Accuracy with Platinum Sensors	8-5
8.2.5	Creating a SoftCal Calibration Curve	8-6
8.3	Internal Programming	8-6

8.3.1	Program Instructions	8-7
8.3.1.1	Ramp Setpoint Absolute	8-7
8.3.1.2	Ramp Setpoint Relative	8-7
8.3.1.3	Ramp Manual Output (MOut) Absolute	8-7
8.3.1.4	Ramp Manual Output (MOut) Relative	8-8
8.3.1.5	Control Parameters	8-8
8.3.1.6	Digital Output	8-8
8.3.1.7	Relays	8-8
8.3.1.8	Wait	8-9
8.3.1.9	Settle	8-9
8.3.1.10	Repeat/End Repeat	8-9
8.3.1.11	Call	8-10
8.3.1.12	End	8-10
8.3.1.13	NOP	8-10
8.3.2	Internal Programming Operations	8-10
8.3.3	Enter or Edit an Internal Program	8-10
8.3.4	Saving a Program	8-11
8.3.5	Summary of Key Operation in Program Mode	8-11
8.3.6	Example of an Internal Program (Example 1)	8-12
8.3.7	Example of Using Subprograms (Example 2)	8-13
8.3.8	Run an Internal Program	8-13
8.3.9	Stop a Running Program	8-13
8.3.10	Clear Internal Program Memory	8-14
8.4	Data Card Operation	8-14
8.4.1	Data Logging To A Data Card	8-14
8.4.1.1	Log Setup	8-15
8.4.1.2	Starting Data Logging	8-15
8.4.1.3	Stopping Data Logging	8-15
8.4.1.4	Viewing the Logged Data	8-16
8.4.1.5	Dumping the Logged Data to the Serial I/O Port	8-16
8.4.1.6	Line Power Loss	8-16
8.4.2	Reading From A Data Card	8-17
8.4.3	Writing To A Data Card	8-17
8.4.4	Erasing A Data Card	8-17
9	Remote Operation	9-1
9.0	General	9-1
9.1	IEEE-488 Interface	9-1
9.1.1	IEEE-488 Interface Settings	9-1
9.1.2	IEEE-488 Command Structure	9-1
9.1.2.1	Bus Control Commands	9-2
9.1.2.2	Common Commands	9-2
9.1.2.3	Interface and Device Specific Commands	9-2
9.1.3	Status Registers	9-3
9.1.3.1	Status Byte Register and Service Request Enable Register	9-3
9.1.3.2	Standard Event Status Register and Standard Event Status Enable Register	9-3
9.1.4	IEEE Interface Example Programs	9-4
9.1.4.1	IEEE-488 Interface Board Installation for Visual Basic Program	9-4
9.1.4.2	Visual Basic IEEE-488 Interface Program Setup	9-6
9.1.4.3	IEEE-488 Interface Board Installation for Quick Basic Program	9-9
9.1.4.4	Quick Basic Program	9-9
9.1.4.5	Program Operation	9-12
9.1.5	Troubleshooting	9-12
9.2	Serial Interface Overview	9-13
9.2.1	Changing Baud Rate	9-13
9.2.2	Physical Connection	9-13
9.2.3	Hardware Support	9-14
9.2.4	Character Format	9-14

9.2.5	Message Strings	9-14
9.2.6	Message Flow Control	9-15
9.2.7	Serial Interface Example Programs	9-15
9.2.7.1	Visual Basic Serial Interface Program Setup	9-16
9.2.7.2	Quick Basic Serial Interface Program Setup	9-19
9.2.7.3	Program Operation	9-20
9.2.8	Troubleshooting	9-20
9.3	IEEE-488/Serial Interface Commands	9-21
9.4	IEEE-488/Serial Interface Commands (Alphabetical Listing)	9-23
10	OPTIONS AND ACCESSORIES	10-1
10.0	General	10-1
10.1	Options	10-1
10.2	Accessories	10-1
10.3	Model 3462 Dual Standard Input Option Card	10-5
10.3.1	Field Installation	10-5
10.3.2	Operation	10-7
10.3.3	Specifications	10-7
10.4	Model 3464 Dual Thermocouple Input Option Card	10-7
10.4.1	General	10-7
10.4.2	Option Installation	10-8
10.4.3	Sensor Installation	10-8
10.4.3.1	Sensor Input Terminals	10-8
10.4.3.2	Measurement Point Connection	10-9
10.4.3.3	Grounding and Shielding	10-9
10.4.4	Operation	10-9
10.4.4.1	Default Settings	10-9
10.4.4.2	Input Selection	10-9
10.4.4.3	Displaying Option Readings	10-9
10.4.4.4	Curve Selection	10-10
10.4.4.5	Curve Data Format	10-10
10.4.4.6	Range Selection	10-10
10.4.4.7	Room Temperature Compensation	10-10
10.4.5	Computer Interface Commands	10-11
10.4.6	Thermocouple Temperature Curves	10-12
10.4.7	Specifications	10-12
10.5	Model 3465 Single Capacitance Input Option Card	10-12
10.5.1	Option Installation	10-12
10.5.2	Sensor Installation	10-12
10.5.2.1	Sensor Input Connector	10-12
10.5.2.2	Measurement Point Connection	10-12
10.5.2.3	Grounding and Shielding	10-12
10.5.3	Operation	10-13
10.5.3.1	Input Selection	10-13
10.5.3.2	Displaying Option Readings	10-13
10.5.3.3	Curve Selection	10-13
10.5.3.4	Range Selection	10-13
10.5.3.5	Temperature Coefficient	10-13
10.5.3.6	Control Channel Changes	10-13
10.5.4	Computer Interface Commands	10-13
10.5.5	Specifications	10-13
10.6	Model 3468 Eight-channel Input Option Card	10-14
10.6.1	General	10-14
10.6.2	Option Installation	10-14
10.6.3	Sensor Installation	10-14
10.6.3.1	Sensor Input Connector	10-14
10.6.3.2	Sensor Input Cabling	10-14
10.6.3.3	Reading Rate	10-14

10.6.4	Operation	10-15
10.6.4.1	General Operation	10-15
10.6.4.2	Input Setup	10-15
10.6.4.3	Temperature Control	10-15
10.6.5	Computer Interface Commands	10-16
10.6.6	Specifications	10-16
11	SERVICE	11-1
11.0	General	11-1
11.1	General Maintenance Precautions	11-1
11.2	Electrostatic Discharge	11-1
11.2.1	Identification of Electrostatic Discharge Sensitive Components	11-2
11.2.2	Handling of Electrostatic Discharge Sensitive Components	11-2
11.3	Line Input Assembly	11-2
11.3.1	Line Voltage	11-3
11.3.2	Fuse Verification	11-3
11.3.3	Line Voltage Selection	11-3
11.3.4	Fuse Removal and Replacement	11-4
11.4	General Maintenance	11-4
11.4.1	Cleaning	11-4
11.5	Rear Panel Connector Definitions	11-4
11.5.1	IEEE-488 Interface Connector	11-7
11.6	Serial Interface Cable and Adapters	11-8
11.7	Top of Enclosure Remove and Replace Procedure	11-9
11.8	EPROM and NOVRAM Replacement	11-9
11.9	Error Messages	11-10
11.10	Firmware IC Replacement	11-11
11.11	Updating The Master Firmware From A Data Card	11-13
A1	APPENDIX A – CURVE TABLES	A1

LIST OF FIGURES

<i>Figure No.</i>	<i>Title</i>	<i>Page</i>
Figure 2-1.	Silicon Diode Sensor Calibrations and CalCurve	2-3
Figure 2-2.	Typical Sensor Installation In A Mechanical Refrigerator	2-5
Figure 2-3.	Examples of PID Control	2-10
Figure 3-1.	Typical Cryogenic Storage Dewar	3-3
Figure 3-2.	Model 340 Rear Panel	3-4
Figure 3-3.	Line Input Assembly	3-5
Figure 3-4.	Fuse Data Legends	3-5
Figure 3-5.	Model 3003 Heater output Conditioner	3-9
Figure 3-6.	Analog OUT 1 and 2 BNC Rear Panel Connector Details	3-11
Figure 3-7.	Digital I/O DA-15 Rear Panel Connector Details	3-12
Figure 3-8.	Relays LO and HI Rear Panel Connector	3-12
Figure 4-1.	Model 340 Front Panel	4-1
Figure 5-1.	Data Flow	5-5
Figure 6-1.	Record of Zone Settings	6-6
Figure 8-1.	SoftCal Temperature Ranges for Silicon Diode Sensors	8-4
Figure 8-2.	SoftCal Temperature Ranges for Platinum Sensors	8-5
Figure 8-3.	Sample Program #1	8-13
Figure 9-1.	GPIO Setting Configuration	9-5
Figure 9-2.	DEV 12 Device Template Configuration	9-5
Figure 9-3.	Typical National Instruments GPIO Configuration from IBCONF.EXE	9-10
Figure 9-4.	Serial Interface Connections	9-13
Figure 10-1.	Model 2001 RJ-11 Cable Assembly	10-3
Figure 10-2.	Model 2003 RJ-11 to DE-9 Adapter	10-3
Figure 10-3.	Optional Model 2002 RJ-11 to DB-25 Adapter	10-4
Figure 10-4.	Model 3012 Rack-Mount Kit	10-4
Figure 10-5.	Cover and Option Plate Screws	10-5
Figure 10-6.	Model 340 Mounting Holes and Analog Option Plug	10-6
Figure 10-7.	Mounting Holes & Analog Plug	10-6
Figure 10-8.	Model 340 Rear Panel with Model 3462 Option Card Installed	10-7
Figure 10-9.	Model 340 Rear Panel with Model 3464 Option Card Installed	10-8
Figure 10-10.	Sensor Input Connector	10-15
Figure 11-1.	Line Input Assembly	11-2
Figure 11-2.	Fuse Data Legends	11-3
Figure 11-3.	Serial I/O RJ-11 Rear Panel Connector Details	11-4
Figure 11-4.	Digital I/O DA-15 Rear Panel Connector Details	11-5
Figure 11-5.	Relays LO & HI Rear Panel Connector Details	11-5
Figure 11-6.	Analog OUT 1 & 2 BNC Rear Panel Connector Details	11-6
Figure 11-7.	Sensor Input A & B Rear Panel Connector Details	11-6
Figure 11-8.	Heater Output Rear Panel Connector Details	11-6
Figure 11-9.	IEEE-488 Rear Panel Connector Details	11-7
Figure 11-10.	Model 2001 RJ-11 Cable Assembly Wiring Details	11-8
Figure 11-11.	Model 2002 RJ-11 to DB-25 Adapter Wiring Details	11-8
Figure 11-12.	Optional Model 2003 RJ-11 to DE-9 Adapter Wiring Details	11-8
Figure 11-13.	Location Of Internal Components	11-10

LIST OF TABLES

<i>Table No.</i>	<i>Title</i>	<i>Page</i>
Table 1-1.	Sensor Temperature Range	1-4
Table 1-2.	Typical Sensor Performance.....	1-6
Table 1-3.	Input Specifications.....	1-7
Table 1-4.	Sensor Input Configuration	1-8
Table 1-5.	Heater Output Specifications	1-8
Table 1-6.	Loop 1 Full Scale Heater Power at Typical Resistance.....	1-9
Table 3-1.	Comparison of Liquid Helium to Liquid Nitrogen	3-3
Table 3-2.	AC Line Input Definitions	3-5
Table 3-3.	Sensor Input A and B Connector Definition	3-6
Table 5-1.	Sensor Types Recognized by the Model 340	5-1
Table 5-2.	Special Sensor Type Configuration	5-3
Table 5-3.	Standard Curve Table.....	5-4
Table 6-1.	Control Mode Description	6-3
Table 6-2.	Full Scale Heater Power at Typical Resistance.....	6-9
Table 6-3.	Example of Max Current Settings	6-10
Table 8-1.	Recommended Curve Parameters	8-2
Table 8-2.	Storage Capability for a 1MB Data Card	8-14
Table 9-1.	IEEE-488 Interface Program Control Properties.....	9-7
Table 9-2.	Visual Basic IEEE-488 Interface Program	9-8
Table 9-3.	Quick Basic IEEE-488 Interface Program.....	9-11
Table 9-4.	Serial Interface Specifications.....	9-14
Table 9-5.	Serial Interface Program Control Properties.....	9-17
Table 9-6.	Visual Basic Serial Interface Program	9-18
Table 9-7.	Quick Basic Serial Interface Program.....	9-19
Table 10-1.	Thermocouple Polarity	10-8
Table 10-2.	Standard Thermocouple Curves.....	10-10
Table 10-3.	Model 3468 Sensor Input Performance Chart	10-17
Table 11-1.	AC Line Input Definitions	11-3
Table A-1.	Lake Shore DT-470 Standard Curve 10 (Curve 1 in the Model 340)	A-1
Table A-2.	Standard DT-500 Silicon Diode Curves	A-2
Table A-3.	Standard Platinum Curves	A-2
Table A-4.	Type K (Nickel-Chromium vs. Nickel-Aluminum) Thermocouple Curve	A-3
Table A-5.	Type E (Nickel-Chromium vs. Copper-Nickel) Thermocouple Curve	A-4
Table A-6.	Type T (Copper vs. Copper-Nickel) Thermocouple Curve	A-5
Table A-7.	Chromel-AuFe 0.03% Thermocouple Curve *	A-6
Table A-8.	Chromel-AuFe 0.07% Thermocouple Curve.....	A-7
Table A-9.	Standard DT-670 Diode Curve	A-8

This Page Intentionally Left Blank

1.2 Temperature Control

The Model 340 offers two proportional-integral-derivative (PID) control loops. A PID control algorithm calculates control output based on temperature setpoint and feedback from the control sensor. Wide tuning parameters accommodate most cryogenic cooling systems and many small high-temperature ovens. Control output is generated by a high-resolution digital-to-analog converter for smooth continuous control. The user can manually set the PID values or the autotuning feature of the Model 340 can automate the tuning process.

The main heater output for the Model 340 is a well-regulated variable DC current source. Heater output is optically isolated from other circuits to reduce interference and ground loops. Heater output can provide up to 100 W of variable DC power to control Loop 1. Features have been added to the Model 340 to minimize the possibility of overheating delicate sensors and wiring in cryostats. These features include setpoint temperature limit, heater current range limit, internal heater diagnostics, and a fuse in the heater output wiring. The Model 340 also has the ability to run a second independent control loop, intended to reduce the temperature gradients in one cooling system rather than to run two different cooling systems.

The setpoint ramp feature allows smooth, continuous changes in setpoint. This feature permits faster experiment cycles, since data can be taken as the system is changing in temperature. It can also be used to make a more predictable approach to a setpoint temperature. The zone feature can automatically change control parameter values for operation over a large temperature range. Values for ten different temperature zones can be loaded into the instrument, which will select the next appropriate zone value on setpoint change.

The Model 340 can run a set of instrument instructions called an internal program. Each program represents the temperature changes needed to conduct a user's experiment. The setpoint can be changed or ramped up and down, and other controller parameters can be programmed. For simple experiments the internal program eliminates the need for computer control. It is also common for the internal program to be used along with the computer interface so the computer is not slowed down by temperature control overhead.

Several math features are included to improve usability and aid in setting up experiments. It is often useful to have reading filters and maximum and minimum calculations easily available on the front panel. The Model 340 also computes a linear equation on reading data to allow flexibility in how the display represents experimental inputs.

1.3 Interface

The Model 340 can be fully involved in computer-controlled experiments. It is equipped with IEEE-488 and RS-232C interfaces. Either interface can send settings to the Model 340 and collect reading data from it. Even the analog outputs, relays, and Digital I/O can be controlled by computer interface.

The Model 340 has several features to make it more valuable as part of a larger measuring system. Two analog voltage outputs can be used to report a voltage that is proportional to the temperature of an input. The outputs can be controlled manually as a voltage source for any other application. Two relays can be used with the alarm setpoints in latching mode for error detection, or in non-latching mode for simple on and off control. Digital I/O can be used with an external scanner or manually.



- | | | |
|-----------------------|------------------------|--------------------------|
| ① Line Input Assembly | ⑥ Data Card | ⑨ Relays |
| ② Heater Fuse | ⑦ IEEE-488 Interface | ⑩ Analog Outputs |
| ③ Heater Output | ⑧ Serial (RS-232C) I/O | ⑪ Standard Sensor Inputs |
| ④ Option Slots | ⑤ Digital I/O | |

1.4 Configurable Display

The Model 340 includes a graphic LCD with fluorescent backlight display that is fully configurable and can display up to eight readings.

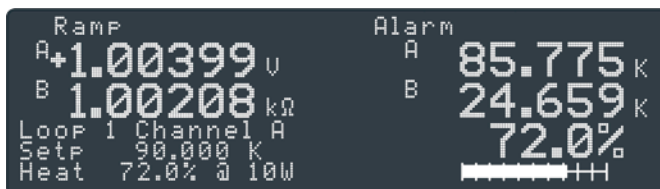

This shows a variation of the display with a large loop 1 heater output graphic bar where the PID parameters are not displayed, but the heater output is more prominent.

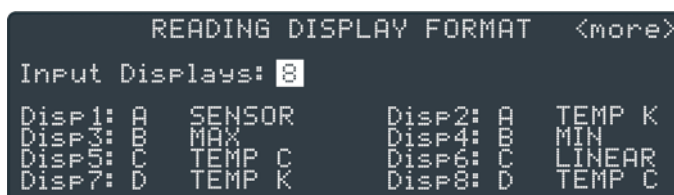

The user can display 1 to 8 readings from any of the available inputs. The units available are the sensor units of mV, V, Ω , k Ω , nF or temperature units of $^{\circ}\text{C}$ or K. Results of the math feature can also be selected.

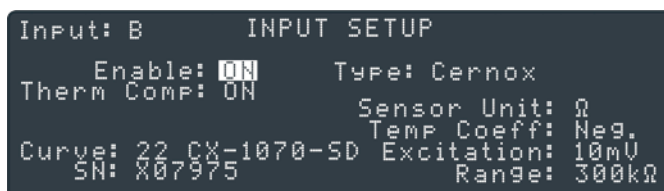

The user can select the sensor type and the controller will automatically select the sensor units, excitation and range. If "special" type is selected, the user can choose any available excitation and input range.

1.5 Additional Inputs Available For Model 340

The following optional inputs are available for the Model 340. Only one can be installed at a time, and the standard inputs stay in the instrument and remain fully functional. Calibration for the option is stored on the card so it can be installed in the field without recalibration.

1.5.1 3462 Dual Standard Input Option Card

Adds two standard inputs to the Model 340, appearing on the display as C and D. The card has separate A/Ds and excitation for each sensor. A microprocessor on the card manages the A/D and communication with the Model 340. Allows the Model 340 to read four sensors and use any of them as a control sensor.

1.5.2 3464 Dual Thermocouple Input Option Card

Adds two new thermocouple inputs to the Model 340, appearing on the display as C and D. The card has separate A/Ds and excitation for each sensor. A microprocessor on the card manages the A/D and communication with the Model 340. Thermocouple inputs range from cryogenic temperature to 1000°C , with built-in room temperature compensation. Curves for thermocouple types E, K, and AuFe 0.07% vs. Cr are included. The user can add other types.

1.5.3 3465 Single Capacitance Input Option Card

Adds a new capacitance input to the Model 340, appearing on the display as C. The card has separate A/D and excitation for the sensor. A microprocessor on the card manages the A/D and communication with the

Model 340. The 3465 is intended to control temperature in strong magnetic fields using a Lake Shore Model CS-501 capacitance temperature sensor.

1.5.4 3468 Eight Channel Input Option Card

Adds eight sensor inputs to the Model 340. The optional inputs are broken into two groups of four and appear on the display as C1–C4 for Input C, D1–D4 for Input D. The 3468 includes two A/D converters, one for each group of four inputs, and individual excitation for each sensor. Each input group must use the same sensor type, but the two groups can be different. The multiplexed inputs provide new readings for all eight inputs twice each second. The 3468 inputs are not recommended for temperature control because the reading rate is too slow to allow good stability.

A variety of sensor types are supported by the Model 3468, but not as many as the standard inputs. Diode and platinum configurations have similar specifications to the standard inputs, reduced only slightly to account for multiplexing. However, the NTC RTD configuration is quite different than the standard inputs. The option has a limited resistance range of 7.5 kΩ with a fixed current excitation of 10 μA. This limitation significantly reduces the low temperature range of the inputs. The option also does not support current reversal to reduce the effect of thermal EMF voltages. The original standard inputs remain fully functional allowing the Model 340 to measure 10 sensors when the option is installed.

1.6 Sensor Selection

Table 1-1 Sensor Temperature Range

		Model	Useful Range	Magnetic Field Use
Diodes <i>340/3462</i>	Silicon Diode	DT-670-SD	1.4 K to 500 K	$T \geq 60 \text{ K} \ \& \ B \leq 3 \text{ T}$
	Silicon Diode	DT-670E-BR	30 K to 500 K	$T \geq 60 \text{ K} \ \& \ B \leq 3 \text{ T}$
	Silicon Diode	DT-414	1.4 K to 375 K	$T \geq 60 \text{ K} \ \& \ B \leq 3 \text{ T}$
	Silicon Diode	DT-421	1.4 K to 325 K	$T \geq 60 \text{ K} \ \& \ B \leq 3 \text{ T}$
	Silicon Diode	DT-470-SD	1.4 K to 500 K	$T \geq 60 \text{ K} \ \& \ B \leq 3 \text{ T}$
	Silicon Diode	DT-471-SD	10 K to 500 K	$T \geq 60 \text{ K} \ \& \ B \leq 3 \text{ T}$
	GaAlAs Diode	TG-120-P	1.4 K to 325 K	$T \geq 4.2 \text{ K} \ \& \ B \leq 5 \text{ T}$
	GaAlAs Diode	TG-120-PL	1.4 K to 325 K	$T > 4.2 \text{ K} \ \& \ B \leq 5 \text{ T}$
	GaAlAs Diode	TG-120-SD	1.4 K to 500 K	$T > 4.2 \text{ K} \ \& \ B \leq 5 \text{ T}$
Positive Temperature Coefficient RTDs <i>340/3462</i>	100 Ω Platinum	PT-102/3	14 K to 873 K	$T > 40 \text{ K} \ \& \ B \leq 2.5 \text{ T}$
	100 Ω Platinum	PT-111	14 K to 673 K	$T > 40 \text{ K} \ \& \ B \leq 2.5 \text{ T}$
	Rhodium-Iron	RF-800-4	1.4 K to 500 K	$T > 77 \text{ K} \ \& \ B \leq 8 \text{ T}$
	Rhodium-Iron	RF-100T/U	1.4 K to 325 K	$T > 77 \text{ K} \ \& \ B \leq 8 \text{ T}$
Negative Temperature Coefficient RTDs <i>340/3462</i>	Cernox™	CX-1010	0.3 K to 325 K ³	$T > 2 \text{ K} \ \& \ B \leq 19 \text{ T}$
	Cernox™	CX-1030-HT	0.3 K to 420 K ^{3, 5}	$T > 2 \text{ K} \ \& \ B \leq 19 \text{ T}$
	Cernox™	CX-1050-HT	1.4 K to 420 K ³	$T > 2 \text{ K} \ \& \ B \leq 19 \text{ T}$
	Cernox™	CX-1070-HT	4 K to 420 K ³	$T > 2 \text{ K} \ \& \ B \leq 19 \text{ T}$
	Cernox™	CX-1080-HT	20 K to 420 K ³	$T > 2 \text{ K} \ \& \ B \leq 19 \text{ T}$
	Germanium	GR-200A-30	0.1 K to 5 K ⁵	Not Recommended
	Germanium	GR-200A-50	0.2 K to 40 K ⁵	Not Recommended
	Germanium	GR-200A-100	0.3 K to 100 K	Not Recommended
	Germanium	GR-200A-250	0.5 K to 100 K	Not Recommended
	Germanium	GR-200A/B-500	1.4 K to 100 K	Not Recommended
	Germanium	GR-200A/B-1000	1.4 K to 100 K	Not Recommended
	Germanium	GR-200A/B-1500	1.4 K to 100 K	Not Recommended
	Germanium	GR-200A/B-2500	1.4 K to 100 K	Not Recommended
	Carbon-Glass	CGR-1-500	1.4 K to 325 K	$T > 2 \text{ K} \ \& \ B \leq 19 \text{ T}$
	Carbon-Glass	CGR-1-1000	1.7 K to 325 K ⁴	$T > 2 \text{ K} \ \& \ B \leq 19 \text{ T}$
	Carbon-Glass	CGR-1-2000	2 K to 325 K ⁴	$T > 2 \text{ K} \ \& \ B \leq 19 \text{ T}$
	Rox™	RX-102	0.1 K to 40 K ⁵	$T > 2 \text{ K} \ \& \ B \leq 10 \text{ T}$
Rox™	RX-103	1.4 K to 40 K	$T > 2 \text{ K} \ \& \ B \leq 10 \text{ T}$	

	Rox™	RX-202	0.1 K to 40 K ⁵	T > 2 K & B ≤ 10 T
Thermocouples 3464	Type K	9006-006	3.2 K to 1505 K	Not Recommended
	Type E	9006-004	3.2 K to 934 K	Not Recommended
	Chromel-			
	AuFe 0.07%	9006-002	1.2 K to 610 K	Not Recommended
Capacitance 3465		CS-501	1.4 K to 290 K	Not Recommended
Diodes 3468	Silicon Diode	DT-670-SD	1.4 K to 500 K	T Ω 60 K & B ≤ 3 T
	Silicon Diode	DT-670E-BR	30 K to 500 K	T Ω 60 K & B ≤ 3 T
	Silicon Diode	DT-414	1.4 K to 375 K	T Ω 60 K & B ≤ 3 T
	Silicon Diode	DT-421	1.4 K to 325 K	T Ω 60 K & B ≤ 3 T
	Silicon Diode	DT-470-SD	1.4 K to 500 K	T Ω 60 K & B ≤ 3 T
	Silicon Diode	DT-471-SD	10 K to 500 K	T Ω 60 K & B ≤ 3 T
	GaAlAs Diode	TG-120-P	1.4 K to 325 K	T > 4.2 K & B ≤ 5 T
	GaAlAs Diode	TG-120-PL	1.4 K to 325 K	T > 4.2 K & B ≤ 5 T
	GaAlAs Diode	TG-120-SD	1.4 K to 500 K	T > 4.2 K & B ≤ 5 T
Positive Temperature Coefficient RTDs 3468	100 Ω Platinum	PT-102/3	14 K to 800 K	T > 40 K & B ≤ 2.5 T
	100 Ω Platinum	PT-111	14 K to 673 K	T > 40 K & B ≤ 2.5 T
	Rhodium-Iron	RF-800-4	1.4 K to 500 K	T > 77 K & B ≤ 8 T
	Rhodium-Iron	RF-100T/U	1.4 K to 325 K	T > 77 K & B ≤ 8 T
Negative Temperature Coefficient RTDs² 3468	Cernox™	CX-1010	2 K to 325 K ⁵	T > 2 K & B ≤ 19 T
	Cernox™	CX-1030-HT	3.5 K to 420 K ^{3,6}	T > 2 K & B ≤ 19 T
	Cernox™	CX-1050-HT	4 K to 420 K ^{3,6}	T > 2 K & B ≤ 19 T
	Cernox™	CX-1070-HT	15 K to 420 K ³	T > 2 K & B ≤ 19 T
	Cernox™	CX-1080-HT	50 K to 420 K ³	T > 2 K & B ≤ 19 T
	Germanium	GR-200A/B-1000	2.2 K to 100 K ⁴	Not Recommended
	Germanium	GR-200A/B-1500	2.6 K to 100 K ⁴	Not Recommended
	Germanium	GR-200A/B-2500	3.1 K to 100 K ⁴	Not Recommended
	Carbon-Glass	CGR-1-500	4 K to 325 K ⁵	T > 2 K & B ≤ 19 T
	Carbon-Glass	CGR-1-1000	5 K to 325 K ⁵	T > 2 K & B ≤ 19 T
	Carbon-Glass	CGR-1-2000	6 K to 325 K ⁵	T > 2 K & B ≤ 19 T
	Rox™	RX-102A	1.4 K to 40 K ⁵	T > 2 K & B ≤ 10 T

² Single excitation current may limit the low temperature range of NTC resistors

³ Non-HT version maximum temperature: 325 K

⁴ Low temperature limited by input resistance range

⁵ Low temperature specified with self-heating error: ≤ 5 mK

⁶ Low temperature specified with self-heating error: ≤ 12 mK

Silicon diodes are the best choice for general cryogenic use from 1.4 K to above room temperature. Diodes are economical to use because they follow a standard curve and are interchangeable in many applications. They are not suitable for use in ionizing radiation or magnetic fields.

Cernox™ thin-film RTDs offer high sensitivity and low magnetic field-induced errors over the 0.3 K to 420 K temperature range. Cernox sensors require calibration.

Platinum RTDs offer high uniform sensitivity from 30 K to over 800 K. With excellent reproducibility, they are useful as thermometry standards. They follow a standard curve above 70 K and are interchangeable in many applications.

Table 1-2 Typical Sensor Performance

340/3462	Example Lake Shore Sensor	Temp	Nominal Resistance/ Voltage	Typical Sensor Sensitivity	Measurement Resolution: Temperature Equivalents	Electronic Accuracy: Temperature Equivalents	Temperature Accuracy including Electronic Accuracy, CalCurve and Calibrated Sensor	Electronic Control Stability Temperature Equivalents
Silicon Diode	DT-670-CO-13 with 1.4H calibration	1.4 K	1.664 V	-12.49 mV/K	0.8 mK	±13 mK	±25 mK	±1.6 mK
		77 K	1.028 V	-1.73 mV/K	5.8 mK	±76 mK	±98 mK	±11.6 mK
		300 K	0.5597 V	-2.3 mV/K	4.4 mK	±47 mK	±79 mK	±8.8 mK
		500 K	0.0907 V	-2.12 mV/K	4.8 mK	±40 mK	±90 mK	±9.6 mK
Silicon Diode	DT-470-SD-13 with 1.4H calibration	1.4 K	1.6981 V	-13.1 mV/K	0.8 mK	±13 mK	±25 mK	±1.6 mK
		77 K	1.0203 V	-1.92 mV/K	5.2 mK	±69 mK	±91 mK	±10.4 mK
		300 K	0.5189 V	-2.4 mV/K	4.2 mK	±45 mK	±77 mK	±8.4 mK
		475 K	0.0906 V	-2.22 mV/K	4.5 mK	±38 mK	±88 mK	±9 mK
GaAlAs Diode	TG-120-SD with 1.4H calibration	1.4 K	5.391 V	-97.5 mV/K	0.1 mK	±7 mK	±19 mK	±0.2 mK
		77 K	1.422 V	-1.24 mV/K	8.1 mK	±180 mK	±202 mK	±16.2 mK
		300 K	0.8978 V	-2.85 mV/K	3.6 mK	±60 mK	±92 mK	±7.2 mK
		475 K	0.3778 V	-3.15 mV/K	3.2 mK	±38 mK	±88 mK	±8.4 mK
100 Ω Platinum RTD 500 Ω Full Scale	PT-103 with 14J calibration	30 K	3.660 Ω	0.191 Ω/K	5.3 mK	±13 mK	±23 mK	±10.6 mK
		77 K	20.38 Ω	0.423 Ω/K	2.4 mK	±10 mK	±22 mK	±4.8 mK
		300 K	110.35 Ω	0.387 Ω/K	2.6 mK	±34 mK	±57 mK	±5.2 mK
		500 K	185.668 Ω	0.378 Ω/K	2.7 mK	±55 mK	±101 mK	±5.4 mK
Cernox™	CX-1010-SD with 0.3L calibration	0.3 K	2322.4 Ω	-10785 Ω/K	3 μK	±0.2 mK	±3.7 mK	±6 μK
		0.5 K	1248.2 Ω	-2665.2 Ω/K	12 μK	±0.5 mK	±5 mK	±24 μK
		4.2 K	277.32 Ω	-32.209 Ω/K	94 μK	±6.2 mK	±11.2 mK	±188 μK
		300 K	30.392 Ω	-0.0654 Ω/K	15 mK	±540 mK	±580 mK	±30 mK
Cernox™	CX-1050-SD-HT ⁹ with 1.4M calibration	1.4 K	26566 Ω	-48449 kΩ/K	6 μK	±0.4 mK	±5.4 mK	±12 μK
		4.2 K	3507.2 Ω	-1120.8 kΩ/K	90 μK	±3.4 mK	±8.4 mK	±180 μK
		77 K	205.67 Ω	-2.4116 Ω/K	1.3 mK	±68 mK	±84 mK	±2.6 mK
		420 K	45.03 Ω	-0.0829 Ω/K	12 mK	±520 mK	±585 mK	±24 mK
Germanium	GR-200A-250 with 0.5D calibration	0.5 K	29570 Ω	-221000 Ω/K	14 μK	±0.2 mK	±4.5 mK	±28 μK
		1.4 K	1376 Ω	-2220 Ω/K	140 μK	±0.9 mK	±4.9 mK	±280 μK
		4.2 K	198.9 Ω	-68.9 Ω/K	440 μK	±3.8 mK	±7.8 mK	±880 μK
		100 K	2.969 Ω	-0.025 Ω/K	40 mK	±200 mK	±216 mK	±80 mK
Germanium	GR-200A-500 with 0.5D calibration	1.4 K	8257 Ω	-19400 kΩ/K	52 μK	±0.6 mK	±4.6 mK	±104 μK
		4.2 K	520 Ω	-245 kΩ/K	410 μK	±3.0 mK	±7 mK	±820 μK
		10 K	88.41 Ω	-19.5 Ω/K	515 μK	±5.6 mK	±10.6 mK	±1.03 mK
		100 K	1.751 Ω	-0.014 Ω/K	72 mK	±270 mK	±286 mK	±114 mK
Carbon-Glass	CGR-1-500 with 1.4L calibration	1.4 K	103900 Ω	-520000 Ω/K	58 μK	±0.6 mK	±4.6 mK	±116 μK
		4.2 K	584.6 Ω	-422.3 Ω/K	24 μK	±1.2 mK	±5.2 mK	±48 μK
		77 K	14.33 Ω	-0.098 Ω/K	3.1 mK	±140 mK	±165 mK	±6.2 mK
		300 K	8.55 Ω	-0.0094 Ω/K	32 mK	±1.1 K	±1.2 K	±64 mK
Rox™	RX-102A-AA with 0.3B calibration	0.5 K	3701 Ω	-5478 Ω/K	19 μK	±0.7 mK	±5.2 mK	±38 μK
		1.4 K	2005 Ω	-667 Ω/K	45 μK	±2.4 mK	±7.4 mK	±90 μK
		4.2 K	1370 Ω	-80.3 Ω/K	375 μK	±16 mK	±32 mK	±750 μK
		40 K	1049 Ω	-1.06 Ω/K	29 mK	±1.1 K	±1.2 K	±58 mK
Thermocouple 50 mV 3464	Type K	75 K	-5862.9 μV	15.6 μV/K	26 mK	±0.25 K ¹⁰	Calibration not available from Lake Shore	±52 mK
		300 K	1075.3 μV	40.6 μV/K	10 mK	±0.038 K ¹⁰		±20 mK
		600 K	13325 μV	41.7 μV/K	10 mK	±0.184 K ¹⁰		±20 mK
		1505 K	49998.3 μV	36.006 μV/K	12 mK	±0.73 K ¹⁰		±24 mK
Capacitance 150 nF 3465	CS-501GR	4.2 K	6 nF	27 pF/K	7.4 mK	±2.08 K	Calibration not available from Lake Shore	±14.8 mK
		77 K	9.1 nF	52 pF/K	3.9 mK	±1.14 K		±7.8 mK
		200 K	19.2 nF	174 pF/K	1 mK	±0.4 K		±2 mK

⁷ Typical sensor sensitivities were taken from representative calibrations for the sensor listed

⁸ Control stability of the electronics only, in an ideal thermal system

⁹ Non-HT version maximum temperature: 325 K

¹⁰ Accuracy specification does not include errors from room temperature compensation

1.7 Specifications

Table 1-3 Input Specifications

	Sensor Temperature Coefficient	Input Range	Excitation Current	Display Resolution	Measurement Resolution	Electronic Accuracy	Electronic Control Stability ¹⁰
Diode 340/3462	negative	0 V to 2.5 V	10 μ A \pm 0.05%	10 μ V	10 μ V	\pm 80 μ V \pm 0.005% of rdg	20 μ V
	negative	0 V to 7.5 V	10 μ A \pm 0.05%	10 μ V	10 μ V	\pm 80 μ V \pm 0.01% of rdg	20 μ V
PTC RTD 340/3462	positive	0 Ω to 250 Ω	1 mA	1 m Ω	1 m Ω	\pm 0.002 Ω \pm 0.01% of rdg	2 m Ω
	positive	0 Ω to 500 Ω	1 mA	1 m Ω	1 m Ω	\pm 0.002 Ω \pm 0.01% of rdg	2 m Ω
	positive	0 Ω to 2500 Ω	0.1 mA	10 m Ω	10 m Ω	\pm 0.03 Ω \pm 0.02% of rdg	20 m Ω
NTC RTD 1 mV 340/3462	negative	0 Ω to 10 Ω	100 μ A	100 μ Ω	1 m Ω	\pm 0.02% rng \pm 0.1% rdg	2 m Ω
	negative	0 Ω to 30 Ω	30 μ A	100 μ Ω	3 m Ω	\pm 0.02% rng \pm 0.1% rdg	6 m Ω
	negative	0 Ω to 100 Ω	10 μ A	1 m Ω	10 m Ω	\pm 0.02% rng \pm 0.1% rdg	20 m Ω
	negative	0 Ω to 300 Ω	3 μ A	1 m Ω	30 m Ω	\pm 0.02% rng \pm 0.1% rdg	60 m Ω
	negative	0 Ω to 1 k Ω	1 μ A	10 m Ω	0.1 Ω	\pm 0.02% rng \pm 0.1% rdg	0.2 Ω
	negative	0 Ω to 3 k Ω	300 nA	10 m Ω	0.3 Ω	\pm 0.02% rng \pm 0.1% rdg	0.6 Ω
	negative	0 Ω to 10 k Ω	100 nA	0.1 Ω	1 Ω	\pm 0.02% rng \pm 0.1% rdg	2 Ω
	negative	0 Ω to 30 k Ω	30 nA	0.1 Ω	3 Ω	\pm 0.02% rng \pm 0.1% rdg	6 Ω
NTC RTD 10 mV 340/3462	negative	0 Ω to 30 Ω	300 μ A	100 μ Ω	300 μ Ω	\pm 0.02% rng \pm 0.05% rdg	600 μ Ω
	negative	0 Ω to 100 Ω	100 μ A	1 m Ω	1 m Ω	\pm 0.02% rng \pm 0.05% rdg	2 m Ω
	negative	0 Ω to 300 Ω	30 μ A	1 m Ω	3 m Ω	\pm 0.02% rng \pm 0.05% rdg	6 m Ω
	negative	0 Ω to 1 k Ω	10 μ A	10 m Ω	10 m Ω	\pm 0.02% rng \pm 0.05% rdg	20 m Ω
	negative	0 Ω to 3 k Ω	3 μ A	10 m Ω	30 m Ω	\pm 0.02% rng \pm 0.05% rdg	60 m Ω
	negative	0 Ω to 10 k Ω	1 μ A	0.1 Ω	0.1 Ω	\pm 0.02% rng \pm 0.05% rdg	0.2 Ω
	negative	0 Ω to 30 k Ω	300 nA	0.1 Ω	0.3 Ω	\pm 0.02% rng \pm 0.05% rdg	0.6 Ω
	negative	0 Ω to 100 k Ω	100 nA	1 Ω	3 Ω	\pm 0.02% rng \pm 0.05% rdg	6 Ω
	negative	0 Ω to 300 k Ω	30 nA	1 Ω	30 Ω	\pm 0.02% rng \pm 0.25% rdg	60 Ω
Thermocouple 3464	positive	\pm 25 mV	NA	0.1 μ V	0.2 μ V	\pm 1 μ V \pm 0.05% of rdg ¹²	0.4 μ V
	positive	\pm 50 mV	NA	0.1 μ V	0.4 μ V	\pm 1 μ V \pm 0.05% of rdg ¹²	0.8 μ V
Capacitance 3465	positive or negative	0 nF to 150 nF	4.88 kHz 1 V square wave	10 pF	2.0 pF	\pm 50 pF \pm 0.1% of rdg	4.0 pF
	positive or negative	0 nF to 15 nF	4.88 kHz 1 V square wave	1 pF	0.2 pF	\pm 50 pF \pm 0.1% of rdg	0.4 pF
Diode 3468	negative	0 V to 2.5 V	10 μ A \pm 0.05%	100 μ V	20 μ V	\pm 160 μ V \pm 0.01% of rdg	40 μ V
	negative	0 V to 7.5 V	10 μ A \pm 0.05%	100 μ V	20 μ V	\pm 160 μ V \pm 0.02% of rdg	40 μ V
PTC RTD 3468	positive	0 Ω to 250 Ω	1 mA \pm 0.3%	10 m Ω	2 m Ω	\pm 0.004 Ω \pm 0.02% of rdg	4 m Ω
	positive	0 Ω to 500 Ω	1 mA \pm 0.3%	10 m Ω	2 m Ω	\pm 0.004 Ω \pm 0.02% of rdg	4 m Ω
	positive	0 Ω to 5000 Ω	1 mA \pm 0.3%	100 m Ω	20 m Ω	\pm 0.06 Ω \pm 0.04% of rdg	40 m Ω
NTC RTD 3468	negative	0 Ω to 7500 Ω	10 μ A \pm 0.05%	100 m Ω	50 m Ω	\pm 0.1 Ω \pm 0.04% of rdg	0.1 Ω

¹¹ Control stability of the electronics only, in an ideal thermal system

¹² Accuracy specification does not include errors from room temperature compensation

1.7.1 Thermometry

Number of inputs	2 included (additional inputs optional)
Input configuration	Each input is factory configured as diode/RTD. Thermocouple and capacitance are optional and sold as additional input cards.
Isolation	Sensor inputs optically isolated from other circuits but not from each other
A/D resolution	24-bit analog-to-digital
Input accuracy	Sensor dependent – refer to Input Specifications table
Measurement resolution	Sensor dependent – refer to Input Specifications table
Maximum update rate	Up to 20 readings per s on an input, 40 readings per s on all inputs
Autorange	Automatically selects appropriate NTC RTD range
User curves	Forty 200-point CalCurves™, or user curves

SoftCal™	Improves accuracy of DT-470 diode or platinum RTD sensors
Math	Maximum and minimum of input readings and linear equation
Filter	Averages input readings to quiet display, settable time constant

Table 1-4 Sensor Input Configuration

	Diode/RTD	Thermocouple	Capacitance
Measurement type	4-lead differential	2-lead, room temperature compensated	4-lead
Excitation	Constant current with current reversal for RTDs	NA	4.88 kHz, 1 V square wave
Supported sensors	Diodes: Silicon, GaAlAs RTDs: 100 Ω Platinum, 1000 Ω Platinum, Germanium, Carbon-Glass, Cernox™, and Rox™	Most thermocouple types	CS-501GR
Standard curves	DT-470, DT-500D, DT-670, PT-100, PT-1000, RX-102A, RX-202A	Type E, Type K, Type T AuFe 0.07% vs. Cr, AuFe 0.03% vs. Cr	None
Input connector	6-pin DIN	Ceramic isothermal block	6-pin DIN

1.7.2 Control

Control loops	2
Control type	Closed-loop digital PID with manual heater power output, or open loop
Tuning	Autotune (one loop at a time), manual PID, zones
Control stability	Sensor dependent – to 2× measurement resolution (in an ideal thermal system)
PID control setting	
Proportional (gain)	0 to 1000 with 0.1 setting resolution
Integral (reset)	1 to 1000 with 0.1 setting resolution
Derivative (rate)	1 to 1000 s with 1 s resolution
Manual output	0 to 100% with 0.01% setting resolution
Zone control	10 temperature zones with P, I, D, manual heater power out, and heater range
Setpoint ramping	0.1 K per min to 100 K per min
Safety limits	Setpoint limit, curve temp limits, heater output, slope limit, heater range limit, power up heater off and short-circuit protection

Table 1-5 Heater Output Specifications

	Loop 1	Loop 2
Heater output type	Variable DC current source	Variable DC voltage
Heater output D/A resolution	18-bit	14-bit
Max heater power	100 W	1 W
Max heater output current	2 A	0.1 A
Heater output compliance	50 V	10 V
Heater source impedance	NA	0.01 Ω
Heater output ranges	5 decade steps in power	1
Heater load type	Resistive	Resistive
Heater load range	10 Ω to 100 Ω recommended	100 Ω minimum
Heater load for max power	25 Ω	100 Ω
Heater noise (<1 kHz) RMS	50 μV + 0.001% of output voltage	<0.3 mV
Isolation	Optical isolation between output and other circuits	None
Heater connector	Dual banana	BNC

Table 1-6 Loop 1 Full Scale Heater Power at Typical Resistance

Heater Resistance	Heater Range	Maximum Current			
		2A	1A	0.5A	0.25A
10 Ω	5	40 W	10 W	2.5 W	625 mW
	4	4 W	1 W	250 mW	62.5 mW
	3	0.4 W	100 mW	25 mW	6.25 mW
	2	40 mW	10 mW	2.5 mW	625 μW
	1	4 mW	1 mW	250 μW	62.5 μW
25 Ω	5	100 W	25 W	6.25 W	1.56 W
	4	10 W	2.5 W	625 mW	156 mW
	3	1 W	250 mW	62.5 mW	15.6 mW
	2	100 mW	25 mW	6.25 mW	1.56 mW
	1	10 mW	2.5 mW	625 μW	156 μW
50 Ω	5	50 W	50 W	12.5 W	3.12 W
	4	20 W	5 W	1.25 W	312 mW
	3	2 W	500 mW	125 mW	31.2 mW
	2	200 mW	50 mW	12.5 mW	3.12 mW
	1	20 mW	5 mW	1.25 mW	312 μW

1.7.3 Front Panel

Display	Graphic LCD with fluorescent backlight
No. of reading displays	1 to 8
Display units	Temperature in K, °C, or sensor units
Temp display resolution	0.0001 K below 10 K, 0.001 K above 10 K
Sensor units display resolution	Sensor dependent, to 6 digits
Setpoint setting Resolution	Same as display resolution (actual resolution is sensor dependent)
Heater output display	Numeric display in percent of full scale for power or current – bar graph display of heater output available
Heater output resolution	0.1% numeric or 2% graphical
Keypad	Numeric plus special function
Front panel features	Front panel curve entry, display brightness control, and keypad lock-out

1.7.4 Interfaces

IEEE-488.2 interface	
Features	SH1, AH1, T5, L4, SR1, RL1, PP0, DC1, DT0, C0, E1
Reading rate	To 20 readings per s
Software support	National Instruments LabVIEW™ driver
Serial interface	
Electrical format	RS-232C
Max baud rate	19,200 baud
Connector	RJ-11
Reading rate	To 20 readings per s
Alarms	
Number	Two, high and low, for each installed input
Data source	Temperature, Sensor Units, and Linear Equation
Settings	Source, High and Low Setpoint, Latching or Non-Latching, and Audible On/Off
Actuators	Display, annunciator, beeper, and relays
Relays	
Number	2
Contacts	Normally open (NO), normally closed (NC), and common
Contact Rating	30 VDC at 2 A
Operation	Activate relays on high or low alarms for any input, or manual off/on
Connector	Detachable terminal block
Analog voltage outputs (when not used as control loop 2 output)	
Number	2

Scale	User selected
Update rate	20 readings per s
Data source	Temperature, Sensor Units, and Linear Equation
Settings	Input, Source, Top of Scale, Bottom of Scale, or Manual
Range	±10 V
Resolution	1.25 mV
Accuracy	±2.5 mV
Max output power	1 W
Min load resistance	100 Ω (short-circuit protected)
Source impedance	0.01 Ω
Digital I/O	5 inputs and 5 outputs – TTL voltage level compatible
Data card	PC card Type II slot used for curve transfer, setup storage, and data-logging

1.7.5 General

Ambient temp range	20 °C to 30 °C (68 °F to 86 °F) for specified accuracy; 15 °C to 35 °C (59 °F to 95 °F) for reduced accuracy
Power requirements	100, 120, 220, 240 VAC (+5%, -10%), 50 or 60 Hz; 190 VA
Size	432 mm W × 89 mm H × 368 mm D (17 in × 3.5 in × 14.5 in), full rack
Weight	8 kg (17.6 lb) approx.
Approval	CE mark

1.7.6 Product Configuration

Part Number Description (Input configuration cannot be changed in the field)
 Standard Temperature Controller, all features included:

340 Two Diode/Resistor Inputs

Refer to Chapter 10 of this manual for a complete description of Model 340 options and accessories. Specifications subject to change without notice.

CHAPTER 2

COOLING SYSTEM DESIGN

2.0 GENERAL

Selecting the proper cryostat or cooling source is probably the most important decision in designing a temperature control system. The cooling source defines minimum temperature, cool-down time, and cooling power. This chapter provides information on how to get the best temperature measurement and control from cooling sources with proper setup including sensor and heater installation.

Chapter 2 contains the following major topics. Temperature sensor selection is covered in Paragraph 2.1. Calibrated sensors are covered in Paragraph 2.2. Sensor installation is covered in Paragraph 2.3. Heater selection and installation is covered in Paragraph 2.4. Considerations for good control are covered in Paragraph 2.5. PID Control is covered in Paragraph 2.6. Manual Tuning is covered in Paragraph 2.7. AutoTuning is covered in Paragraph 2.8. Finally, Zone Tuning is covered in Paragraph 2.9.

2.1 TEMPERATURE SENSOR SELECTION

This section is intended to help the user ask the proper questions about sensor selection, and not to give all the answers. Additional useful information on temperature sensor selection is available in the Lake Shore Temperature Measurement and Control Catalog. The catalog has a large reference section that includes sensor characteristics and sensor selection criteria.

Temperature range is discussed in Paragraph 2.1.1. Sensor sensitivity is discussed in Paragraph 2.1.2. Environmental conditions are discussed in Paragraph 2.1.3. Measurement accuracy is discussed in Paragraph 2.1.4. Finally, sensor packages are discussed in Paragraph 2.1.5.

2.1.1 Temperature Range

Several important sensor parameters must be considered when choosing a sensor. The first is temperature range. The experimental temperature range must be known when choosing a sensor. Some sensors can be damaged by temperatures that are either too high or too low. Manufacturer recommendations should always be followed.

Sensor sensitivity is also dependent on temperature and can limit the useful range of a sensor. It is important not to specify a range larger than necessary. If an experiment is being done at liquid helium temperature and a very high sensitivity is needed for good measurement resolution, that same resolution may not be required to monitor warm up to room temperature. Two different sensors may be required to tightly cover the range from helium to room temperature, but lowering the requirement on warm up may allow a less expensive, one sensor solution.

Another factor to consider when choosing a temperature sensor is that instruments like the Model 340 are not able to read some sensors over their entire temperature range. Lake Shore sells calibrated sensors that operate down to 50 millikelvin (mK), but the Model 340 is limited to 300 mK in its standard configuration.

2.1.2 Sensor Sensitivity

Temperature sensor sensitivity is a measure of how much a sensor signal changes when the temperature changes. It is an important sensor characteristic because so many measurement parameters are related to it. Resolution, accuracy, noise floor, and even control stability depend on sensitivity. Many sensors have different sensitivities at different temperatures. For example, a platinum sensor has good sensitivity at higher temperatures but has limited use below 30 kelvin (K) because its sensitivity drops sharply. It is difficult to determine if a sensor has adequate sensitivity over the experimental temperature range. This manual has specifications (Table 1-1) that include sensor sensitivity translated into temperature resolution and accuracy at different points. This is typical sensor response and can be used as a guide when choosing a sensor to be used with the Model 340.

2.1.3 Environmental Conditions

Environmental factors such as high vacuum, magnetic field, corrosive chemicals, or even radiation may limit the effectiveness of some sensors. Lake Shore has devoted much time to develop sensor packages that withstand the environmental factors found in typical cryogenic cooling systems.

Magnetic field experiments are very common. Field dependence is an important selection criteria for temperature sensors used in these experiments. Table 1-1 states the field dependence of most common sensors. The Lake Shore Temperature Measurement and Control Catalog includes detailed field dependence tables along with specific data on other environmental factors when available.

2.1.4 Measurement Accuracy

Temperature measurements have several sources of error that reduce accuracy. Be sure to account for errors induced by both the sensor and the instrumentation when computing accuracy. The instrument has measurement error in reading the sensor signal and error in calculating a temperature using a temperature response curve. Error results from the sensor being compared to a calibration standard and the temperature response of a sensor will shift with time and with repeated thermal cycling (from very cold temperatures to room temperature). Instrument and sensor makers specify these errors but there are things a user can do to maintain good accuracy. For example, choose a sensor that has good sensitivity in the most critical temperature range, as sensitivity can minimize the effect of most error sources. Install the sensor properly following guidelines in Paragraph 2.3. Have the sensor and instrument periodically recalibrated, or in some other way null the time dependent errors. Use a sensor calibration appropriate for the accuracy requirement.

2.1.5 Sensor Package

There are many types of sensor packages which generally determine sensor size, thermal and electrical contact to the outside, and sometimes limit temperature range. Some sensors may be purchased as bare chips without a package. When different packages are available for a sensor, consider the sensor mounting surface and how leads will be heat sinked.

2.2 CALIBRATED SENSORS

It can be difficult to choose the right sensor, calibrate it, translate calibration data into a temperature response curve understandable to the Model 340, and load the curve into the instrument. Lake Shore offers a variety of calibration and curve loading services to fit different accuracy requirements and budgets: traditional calibration in Paragraph 2.2.1, SoftCal™ in Paragraph 2.2.2, standard curves in Paragraph 2.2.3, and the Lake Shore CalCurve Service in Paragraph 2.2.4.

2.2.1 Traditional Calibration

Calibration compares a sensor with an unknown temperature response to an accepted standard. Lake Shore temperature standards are traceable to the U.S. National Institute of Standards and Testing (NIST) or the National Physical Laboratory in Great Britain. These standards allow Lake Shore to calibrate sensors from 50 mK to above room temperature. Calibrated sensors are more expensive than uncalibrated sensors.

Calibrated temperature sensors are the most accurate available from Lake Shore. Errors from sensor calibration are almost always smaller than error contributed by the Model 340. The Lake Shore Temperature Measurement and Control Catalog has complete accuracy specifications for calibrated sensors.

Calibrated sensors include measured test data printed and plotted, coefficients of a Chebychev polynomial fitted to the data, and two tables of data points used as interpolation tables optimized for accurate temperature conversion. The smaller table, called a breakpoint interpolation table, fits into instruments like the Model 340 where it is called a temperature response curve. Install a curve into a Model 340 through a CalCurve™ (Paragraph 2.2.4) or manually through the instrument front panel.

Note instrument specifications before ordering calibrated sensors. A calibrated sensor is required when a sensor does not follow a standard curve *if* the user wishes to display in temperature. Otherwise the Model 340 operates in sensor units like ohms or volts. The Model 340 may not work over the full temperature range of some sensors. The standard inputs are limited to operation above 300 mK even with sensors that can be calibrated to 50 mK.

2.2.2 SoftCal™

SoftCal is a good solution for applications that do not require the accuracy of a traditional calibration. The SoftCal algorithm uses the well-behaved nature of sensors that follow a standard curve to improve the accuracy of individual sensors. A few known temperature points are required to perform SoftCal.

Lake Shore sells SoftCal calibrated sensors that include both the large interpolation table and the smaller breakpoint interpolation table. A CalCurve, described in Paragraph 2.2.4, may be required to get the breakpoint table into a Model 340 where it is called a temperature response curve.

The Model 340 can also perform a SoftCal calibration. The user must provide one, two, or three known temperature reference points. The range and accuracy of the calibration is based on these points.

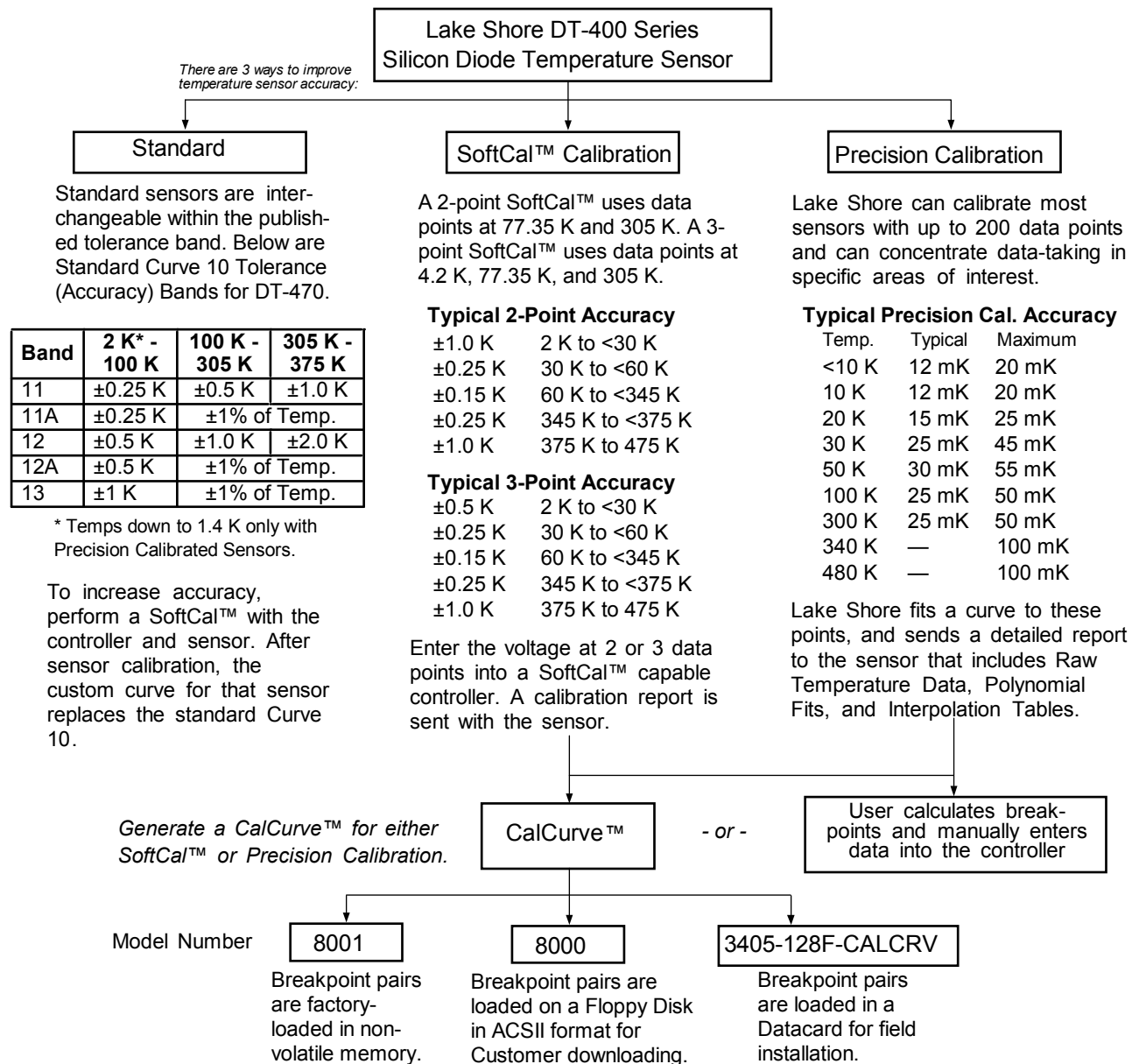

Figure 2-1. Silicon Diode Sensor Calibrations and CalCurve

2.2.3 Standard Curves

Some types of sensors behave in a very predictable manner and a standard temperature response curve can be created for them. Standard curves are a convenient and inexpensive way to get reasonable temperature accuracy. Sensors that have a standard curve are often used when interchangeability is important. Some individual sensors are selected for their ability to match a published standard curve and sold at a premium, but in general these sensors do not provide the accuracy of a calibrated sensor. For convenience, the Model 340 has several standard curves included in firmware.

2.2.4 CalCurve™

The CalCurve service provides the user with a convenient way get the temperature response curve from Lake Shore calibrated sensors into instruments like the Model 340. It can be performed at the factory when calibrated sensors and instruments are ordered together. The factory installed CalCurve option is Model 8001 and should be ordered with the calibrated sensor. A CalCurve can be done in the field when additional or replacement sensors are installed. Curve data is loaded into some type of non-volatile memory that is installed into the instrument by the user. In the case of the Model 340, the curve is loaded into a non-volatile memory card that can be used for transfer into the instrument. The field-installed version is a Model 3405-128F-CALCRV and it should be ordered with the calibrated sensor. Customers that have a PC compatible computer with an RS-232C or IEEE-488 interface have another option. The Model 8000 can also be ordered with the calibrated sensor.

2.3 SENSOR INSTALLATION

This section highlights some of the important elements of proper sensor installation. For more detailed information, Lake Shore sensors are shipped with installation instructions that cover that specific sensor type and package. The Lake Shore Temperature Measurement and Control Catalog includes an installation section as well. To further help users properly install sensors, Lake Shore offers a line of Cryogenic Accessories. Many of the materials discussed are available through Lake Shore and can be ordered with sensors or instruments.

Mounting materials is discussed in Paragraph 2.3.1. Sensor location is discussed in Paragraph 2.3.2. Thermal conductivity is discussed in Paragraph 2.3.3. Contact area is discussed in Paragraph 2.3.4. Contact pressure is discussed in Paragraph 2.3.5. Lead wire is discussed in Paragraph 2.3.6. Lead soldering is discussed in Paragraph 2.3.7. Heat sinking leads is discussed in Paragraph 2.3.8. Finally, thermal radiation is discussed in Paragraph 2.3.9.

2.3.1 Mounting Materials

Choosing appropriate mounting materials is very important in a cryogenic environment. The high vacuum used to insulate cryostats is one source of problems. Materials used in these applications should have a low vapor pressure so they do not evaporate or out-gas and spoil the vacuum insulation. Metals and ceramics do not have this problem but greases and varnishes must be checked. Another source of problems is the wide extremes in temperature most sensors are exposed to. The linear expansion coefficient of a material becomes important when temperature changes are so large. Never try to permanently bond materials with linear expansion coefficients that differ by more than three. A flexible mounting scheme should be used or the parts will break apart, potentially damaging them. The thermal expansion or contraction of rigid clamps or holders could crush fragile samples or sensors that do not have the same coefficient. Thermal conductivity is a property of materials that can change with temperature. Do not assume that a heat sink grease that works well at room temperature and above will do the same job at low temperatures.

2.3.2 Sensor Location

Finding a good place to mount a sensor in an already crowded cryostat is never easy. There are fewer problems if the entire load and sample holder are at the same temperature. Unfortunately, this not the case in many systems. Temperature gradients (differences in temperature) exist because there is seldom perfect balance between the cooling source and heat sources. Even in a well-controlled system, unwanted heat sources like thermal radiation and heat conducting through mounting structures can cause gradients. For best accuracy, sensors should be positioned near the sample, so that little or no heat flows between the sample and sensor. This may not, however, be the best location for temperature control as discussed below.

2.3.3 Thermal Conductivity

The ability of heat to flow through a material is called thermal conductivity. Good thermal conductivity is important in any part of a cryogenic system that is intended to be the same temperature. Copper and aluminum are examples of metals that have good thermal conductivity, while stainless steel does not. Non-metallic, electrically-insulating materials like alumina oxide and similar ceramics have good thermal conductivity, while G-10 epoxy-impregnated fiberglass does not. Sensor packages, cooling loads, and sample holders should have good thermal conductivity to reduce temperature gradients. Surprisingly, the connections between thermally conductive mounting surfaces often have very poor thermal conductivity.

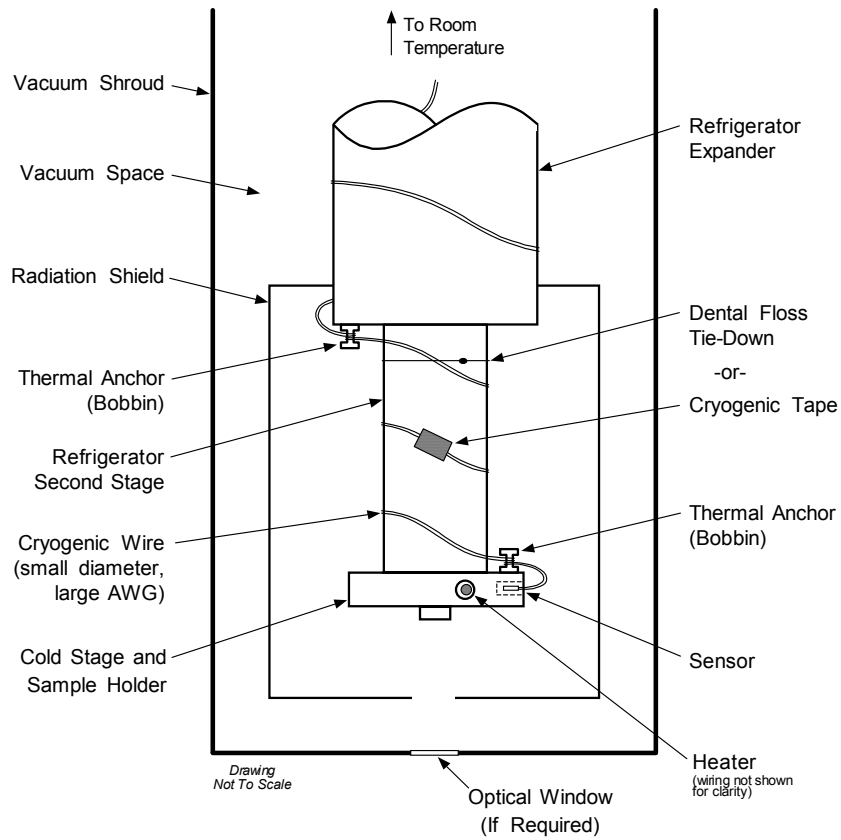

Figure 2-2. Typical Sensor Installation In A Mechanical Refrigerator

2.3.4 Contact Area

Thermal contact area greatly affects thermal conduction because a larger area has more opportunity to transfer heat. Even when the size of a sensor package is fixed, thermal contact area can be improved with the use of a gasket material. A soft gasket material forms into the rough mating surface to increase the area of the two surfaces that are in contact. Good gasket materials are soft, thin and have good thermal conductivity. They must also withstand the environmental extremes. Indium foil and cryogenic grease are good examples.

2.3.5 Contact Pressure

When sensors are permanently mounted, the solder or epoxy used to hold the sensor act as both gasket and adhesive. Permanent mounting is not a good solution for everyone because it limits flexibility and can potentially damage sensors. Much care should be taken not to over heat or mechanically stress sensor packages. Less permanent mountings require some pressure to hold the sensor to its mounting surface. Pressure greatly improves the action of gasket material to increase thermal conductivity and reduce thermal gradients. A spring clamp is recommended so that different rates of thermal expansion do not increase or decrease pressure with temperature change.

2.3.6 Lead Wire

Different types of sensors come with different types and lengths of electrical leads. In general, a significant length of lead wire must be added to the sensor for proper heat sinking and connecting to a bulk head connector at the vacuum boundary. The lead wire must be a good electrical conductor, but a poor *thermal* conductor, or heat will transfer down the leads and change the temperature reading of the sensor. Small 30 to 40 AWG wire made of an alloy like phosphor bronze is much better than copper wire. Thin wire insulation is preferred and twisted wire should be used to reduce the effect of RF noise if it is present. The wire used on the room temperature side of the vacuum boundary is not critical so copper cable is normally used.

2.3.7 Lead Soldering

When additional wire is soldered to short sensor leads, care must be taken not to overheat the sensor. A heat sink such as a metal wire clamp or alligator clip will heat sink the leads and protect the sensor. Leads should be tinned before bonding to reduce the time that heat is applied to the sensor lead. Solder flux should be cleaned after soldering to prevent corrosion.

2.3.8 Heat Sinking Leads

Sensor leads can be a significant source of error if they are not properly heat sunk. Heat will transfer down even small leads and alter the sensor reading. The goal of heat sinking is to cool the leads to a temperature as close to the sensor as possible. This can be accomplished by putting a significant length of lead wire in thermal contact with every cooled surface between room temperature and the sensor. Lead wires can be adhered to cold surfaces with varnish over a thin electrical insulator like cigarette paper. They can also be wound onto a bobbin that is firmly attached to the cold surface. Some sensor packages include a heat sink bobbin and wrapped lead wires to simplify heat sinking.

2.3.9 Thermal Radiation

Thermal (black body) radiation is one of the ways heat is transferred. Warm surfaces radiate heat to cold surfaces even through a vacuum. The difference in temperature between the surfaces is one thing that determines how much heat is transferred. Thermal radiation causes thermal gradients and reduces measurement accuracy. Many cooling systems include a radiation shield. The purpose of the shield is to surround the load, sample, and sensor with a surface that is at or near their temperature to minimize radiation. The shield is exposed to the room temperature surface of the vacuum shroud on its outer surface, so some cooling power must be directed to the shield to keep it near the load temperature. If the cooling system does not include an integrated radiation shield (or one cannot be easily made), one alternative is to wrap several layers of super-insulation (aluminized Mylar) loosely between the vacuum shroud and load. This reduces radiation transfer to the sample space.

2.4 HEATER SELECTION AND INSTALLATION

There is a variety of resistive heaters that can be used as the controlled heating source for temperature control. The mostly metal alloys like nichrome are usually wire or foil. Shapes and sizes vary to permit installation into different systems.

Heater Resistance and power are discussed in Paragraph 2.4.1. Heater location is discussed in Paragraph 2.4.2. Heater types are discussed in Paragraph 2.4.3. Finally, heater wiring is discussed in Paragraph 2.4.4.

2.4.1 Heater Resistance and Power

Cryogenic cooling systems have a wide range of cooling power. The resistive heater must be able to provide sufficient heating power to warm the system. The Model 340 can supply up to 100 W of power to a heater (if the heater resistance is appropriate). The Model 340 heater output current source has a maximum output of 2 A, limiting maximum power to: **Max Power (watts) = (2 A)² × Resistance (ohms)**.

Even though the Model 340 output is a current source, it has a voltage limit (called the compliance voltage) of 50 V, which also limits maximum power:

$$\text{Max Power (watts)} = \frac{(50 \text{ volts})^2}{\text{Resistance (ohms)}}$$

Heater Resistance and Power (Continued)

Both limits are in place at the same time, so the smaller of the two computations gives the maximum power available to the heater. A heater of 25 Ω allows the instrument to provide its maximum power of 100 watts. A typical smaller resistance of 10 Ω allows 40 watts of power, while a typical larger resistance of 50 Ω allows 50 watts. The resistor chosen as a heater must be able to withstand the power being dissipated in it. Pre-packaged resistors have a power specification that is usually given for the resistor in free air. This power may need to be derated if used in a vacuum where convection cooling cannot take place and it is not adequately heat sunk to a cooled surface.

2.4.2 Heater Location

For best temperature measurement accuracy, the heater should be located so that heat flow between the cooling power and heater is minimized. For best control the heater should be in close thermal contact with the cooling power. Geometry of the load can make one or both of these difficult to achieve. That is why there are several heater shapes and sizes.

2.4.3 Heater Types

Resistive wire like nichrome is the most flexible type of heater available. The wire can be purchased with electrical insulation and has a predictable resistance per given length. This type of heater wire can be wrapped around a cooling load to give balanced, even heating of the area. Similar to sensor lead wire, the entire length of the heater wire should be in good thermal contact with the load to allow for thermal transfer. Heat sinking also protects the wire from over heating and burning out.

Resistive heater wire is also wound into cartridge heaters. Cartridge heaters are more convenient but are bulky and more difficult to place on small loads. A typical cartridge is $\frac{1}{4}$ inch in diameter and 1 inch long. The cartridge should be snugly held in a hole in the load or clamped to a flat surface. Heat sinking for good thermal contact is again important.

Foil heaters are thin layers of resistive material adhered to, or screened on to, electrically insulating sheets. There are a variety of shapes and sizes. The proper size heater can evenly heat a flat surface or around a round load. The entire active area should be in good thermal contact with the load, not only for maximum heating effect, but to keep spots in the heater from over heating and burning out.

2.4.4 Heater Wiring

Small 30 AWG copper wire is recommended for heater leads inside of a vacuum shroud. Larger wire causes too much heat to leak. These leads should be heat sunk similar to sensor leads so that heat leak does not warm the load when the heater is not running. The lead wires should be twisted to minimize noise coupling between the heater and other leads in the system. Outside the vacuum shroud, larger copper cable should be used but twisting is still recommended.

2.5 CONSIDERATIONS FOR GOOD CONTROL

Most of the techniques discussed above to improve cryogenic temperature accuracy apply to control as well. There is an obvious exception in sensor location. A compromise is suggested below in the Two Sensor Approach.

Thermal conductivity is discussed in Paragraph 2.5.1. Thermal lag is discussed in Paragraph 2.5.2. The two-sensor approach is discussed in Paragraph 2.5.3. Thermal mass is discussed in Paragraph 2.5.4. Finally, system nonlinearity is discussed in Paragraph 2.5.5.

2.5.1 Thermal Conductivity

Good thermal conductivity is important in any part of a cryogenic system that is intended to be at the same temperature. Most systems begin with materials that have good conductivity themselves, but as sensors, heaters, sample holders, etc., are added to an ever more crowded space, the junctions between parts are often overlooked. In order for control to work well, junctions between the elements of the control loop must be in close thermal contact and have good thermal conductivity. Gasket materials should always be used along with reasonable pressure.

2.5.2 Thermal Lag

Poor thermal conductivity causes thermal gradients that reduce accuracy but they also cause thermal lag that make it difficult for controllers to do their job. Thermal lag is the time it takes for a change in heating or cooling power to propagate through the load and get to the feedback sensor. Because the feedback sensor is the only thing that lets the controller know what is happening in the system, slow information to the sensor slows the controller's response time. For example, if the temperature at the load drops slightly below the setpoint, the controller gradually increases heating power. If the feedback information is slow, the controller puts too much heat into the system before it is told to reduce heat. The excess heat causes a temperature overshoot, degrading control stability. The best way to improve thermal lag is to pay close attention to thermal conductivity both in the parts used and their junctions.

2.5.3 Two-Sensor Approach

There is a conflict between the best sensor location for measurement accuracy and the best sensor location for control. For measurement accuracy, the sensor should be very near the sample being measured, which is away from the heating and cooling sources to reduce heat flow across the sample and thermal gradients. The best control stability is achieved when the feedback sensor is near both the heater and cooling source to reduce thermal lag. If both control stability and measurement accuracy are critical, it may be necessary to use two sensors, one for each function. Many temperature controllers including the Model 340 have two sensor inputs for this reason.

2.5.4 Thermal Mass

Cryogenic designers understandably want to keep the thermal mass of the load as small as possible so the system can cool quickly and improve cycle time. Small mass can also have the advantage of reduced thermal gradients. Controlling a very small mass is difficult because there is no buffer to adsorb small changes in the system. Without buffering, small disturbances can very quickly create large temperature changes. There are systems where it is necessary to add a small amount of thermal mass such as a copper block in order to improve control stability.

2.5.5 System Nonlinearity

Because of nonlinearities in the control system, a system controlling well at one temperature may not control well at another temperature. While nonlinearities exist in all temperature control systems, they are most evident at cryogenic temperatures. When the operating temperature changes the behavior of the control loop, the controller must be retuned. As an example, a thermal mass acts differently at different temperatures. The specific heat of the load material is a major factor in thermal mass. The specific heat of materials like copper change as much as three orders of magnitude when cooled from 100 K to 10 K. Changes in cooling power and sensor sensitivity are also sources of nonlinearity.

The cooling power of most cooling sources also changes with load temperature. This is very important when operating at temperatures near the highest or lowest temperature that a system can reach. Nonlinearities within a few degrees of these high and low temperatures make it very difficult to configure them for stable control. If difficulty is encountered, it is recommended to gain experience with the system at temperatures several degrees away from the limit and gradually approach it in small steps.

Keep an eye on temperature sensitivity. Sensitivity not only affects control stability but it also contributes to the overall control system gain. The large changes in sensitivity that make some sensors so useful may make it necessary to retune the control loop more often.

2.6 PID CONTROL

The Model 340 Temperature Controller uses an algorithm called PID control for closed-loop control operation. The control equation for the PID algorithm has three variable terms, a P or proportional term, an I or integral term, and a D or derivative term. See Figure 2-3. Changing these variables for best control of a system is called tuning. The PID equation in the Model 340 is:

$$\text{Heater Output} = P \left[e + I \int (e) dt + D \frac{de}{dt} \right] \quad \text{where error (e) = Setpoint - Feedback Reading.}$$

Proportional (P) is discussed in Paragraph 2.6.1. Integral (I) is discussed in Paragraph 2.6.2. Derivative (D) is discussed in Paragraph 2.6.3. Finally, the manual heater output is discussed in Paragraph 2.6.4.

2.6.1 Proportional (P)

The Proportional term, also called gain, must have a value greater than zero for the control loop to operate. The value of the proportional term is multiplied by the error (e) which is defined as the difference between the setpoint and feedback temperatures, to generate the proportional contribution to the output: Output (P) = Pe. If proportional is acting alone, with no integral, there must always be an error or the output will go to zero. A great deal must be known about the load, sensor, and controller to compute a proportional setting (P). Most often, the proportional setting is determined by trial and error. The proportional setting is part of the overall control loop gain, and so are the heater range and cooling power. The proportional setting will need to change if either of these change.

2.6.2 Integral (I)

In the control loop, the integral term, also called reset, looks at error over time to build the integral contribution to the output:

$$\text{Output (I)} = PI \int (e) dt.$$

By adding the integral to proportional contributions, the error that is necessary in a proportional only system can be eliminated. When the error is at zero, controlling at the setpoint, the output is held constant by the integral contribution. The integral setting (I) is more predictable than the gain setting. It is related to the dominant time constant of the load. As discussed in Paragraph 2.7.3, measuring this time constant allows a reasonable calculation of the integral setting. In the Model 340, the integral term is not set in seconds like some other systems. The integral setting can be derived by dividing 1000 by the integral seconds:

$$I_{\text{setting}} = 1000 / I_{\text{seconds}}.$$

2.6.3 Derivative (D)

The derivative term, also called rate, acts on the change in error with time to make its contribution to the output:

$$\text{Output (D)} = PD \frac{de}{dt}.$$

By reacting to a fast-changing error signal the derivative can work to boost the output when the setpoint changes quickly, reducing the time it takes for temperature to reach the setpoint. It can also see the error decreasing rapidly when the temperature nears the setpoint and reduce the output for less overshoot. The derivative term can be useful in fast changing systems but it is often turned off during steady state control because it reacts too strongly to small disturbances. The derivative setting (D) is related to the dominant time constant of the load similar to the I setting. The derivative term is set in seconds.

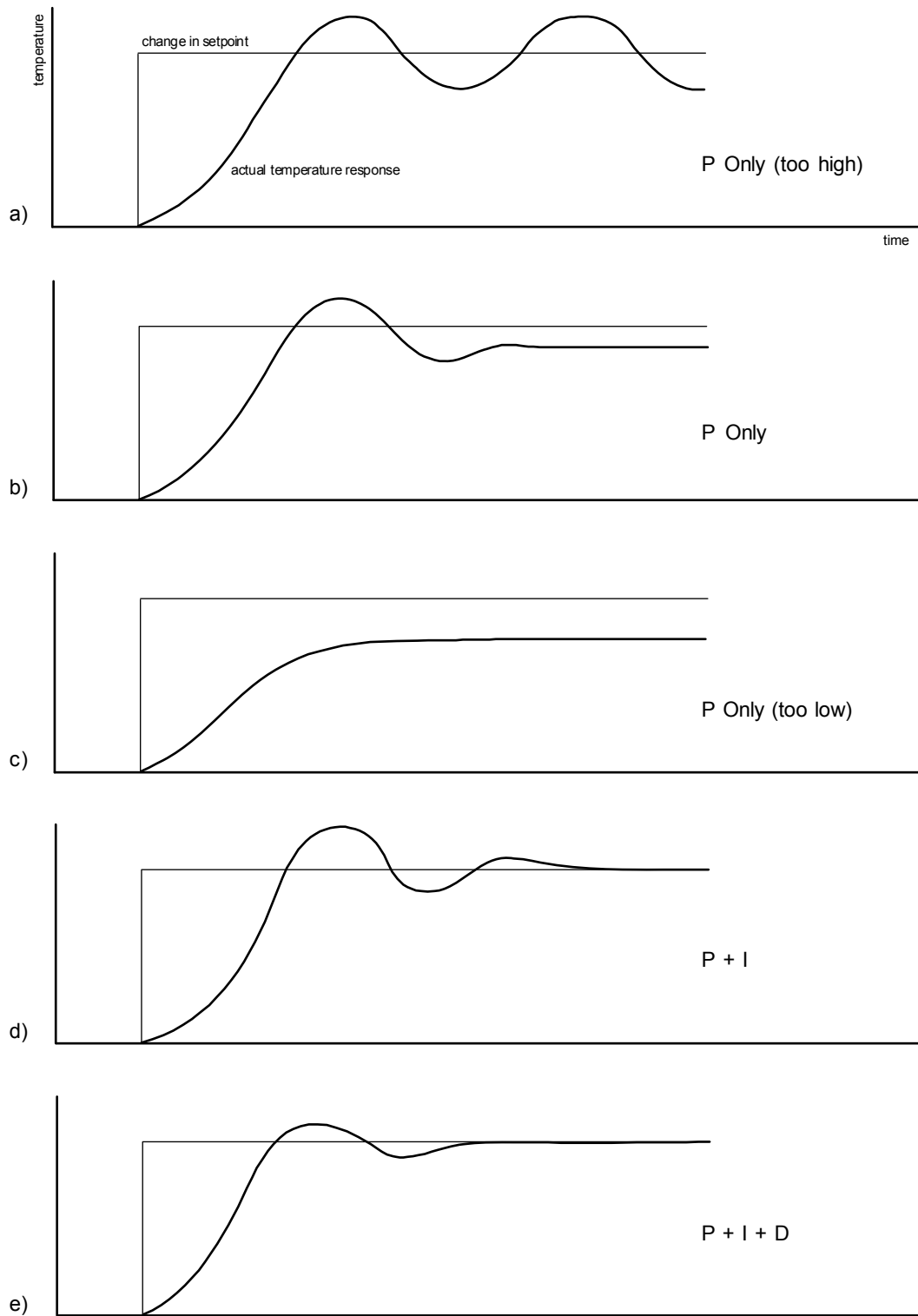

340-2-3.bmp

Figure 2-3. Examples of PID Control

2.6.4 Manual Heater Output (MHP)

The Model 340 has a control setting that is not a normal part of a PID control loop. Manual heater output can be used for open loop control, meaning feedback is ignored and the heater output stays at the users manual setting. This is a good way to put constant heating power into a load when needed. The manual output term can also be added to the PID output. Some users prefer to set a power near that necessary to control at a setpoint and let the closed loop make up the small difference. Manual output is set in percent of full scale current or power for a given heater range.

2.7 MANUAL TUNING

There has been a lot written about tuning closed loop control systems and specifically PID control loops. This section does not attempt to compete with control theory experts. It describes a few basic rules of thumb to help less experienced users get started. This technique will not solve every problem, but it has worked for many others in the field. This section assumes the user has worked through the operation sections of this manual, has a good temperature reading from the sensor chosen as a control sensor, and is operating Loop 1. It is also a good idea to begin at the center of the temperature range of the cooling system (not close to its highest or lowest temperature). AutoTune (Paragraph 2.8) is another good place to begin, and do not forget the power of trial and error.

Setting the heater range is discussed in Paragraph 2.7.1. Manually tuning Proportional (P) is discussed in Paragraph 2.7.2. Manually tuning Integral (I) is discussed in Paragraph 2.7.3. Finally, manually tuning Derivative (D) is discussed in Paragraph 2.7.4.

2.7.1 Setting Heater Range

Setting an appropriate heater output range is an important first part of the tuning process. *The heater range should allow enough heater power to comfortably overcome the cooling power of the cooling system.* If the heater range will not provide enough power, the load will not be able to reach the setpoint temperature. If the range is set too high, the load may have very large temperature changes that take a long time to settle out. Delicate loads can even be damaged by too much power.

Often there is little information on the cooling power of the cooling system at the desired setpoint. If this is the case, try the following: Allow the load to cool completely with the heater off. Set manual heater output to 50% while in Open Loop control mode. Turn the heater to the lowest range and write down the temperature rise (if any). Select the next highest heater range and continue the process until the load warms up to room temperature. If the load never reaches room temperature, some adjustment may be needed in heater resistance or maximum heater current.

The list of heater range versus load temperature is a good reference for selection the proper heater range. It is common for systems to require two or more heater ranges for good control over their full temperature. Lower heater ranges are normally needed for lower temperature. The Model 340 is of no use controlling at or below the temperature reached when the heater was off. Many systems can be tuned to control within a degree or two above that temperature.

2.7.2 Tuning Proportional

The proportional setting is so closely tied to heater range that it can be thought of as fine and coarse adjustments of the same setting. An appropriate heater range must be known before moving on to the proportional setting.

Begin this part of the tuning process by letting the cooling system cool and stabilize with the heater off. Place the Model 340 in Manual PID control mode, then turn integral, derivative and manual output settings off. Enter a setpoint several degrees above the cooling systems lowest temperature. Enter a low proportional setting of approximately 5 or 10 and then enter the appropriate heater range as described above. The heater display should show a value greater than zero and less than 100%. The load temperature should stabilize at a temperature below the setpoint. If the load temperature and heater meter swing rapidly, the heater range may be set too high and should be reduced. Very slow changes in load temperature that could be described as drifting are an indication of a proportional setting that is too low (which is addressed in the next step).

Tuning Proportional (Continued)

Gradually increase the proportional setting by doubling it each time. At each new setting, allow time for the temperature of the load to stabilize. As the proportional setting is increased, there should be a setting in which the load temperature begins a sustained and predictable oscillation rising and falling in a consistent period of time. See Figure 2-3a. The goal is to find the proportional value in which the oscillation begins, do not turn the setting so high that temperature and heater output changes become violent.

Record the proportional setting and the amount of time it takes for the load change from one temperature peak to the next. The time is called the oscillation period of the load and it helps describe the dominant time constant of the load which is used in setting integral. If all has gone well, the appropriate proportional setting is *one half* of the value required for sustained oscillation. See Figure 2-3b.

If the load does not oscillate in a controlled manner, the heater range could be set too low. A constant heater reading of 100% on the display would be an indication of a low range setting. The heater range could also be too high, indicated by rapid changes in the load temperature or heater output with a proportional setting of less than 5. There are a few systems that will stabilize and not oscillate with a very high proportional setting and a proper heater range setting. For these systems, setting a proportional setting of one half of the highest setting is the best choice.

2.7.3 Tuning Integral

When the proportional setting is chosen and the integral is set to zero (off), the Model 340 controls the load temperature below the setpoint. Setting the integral allows the Model 340 control algorithm to gradually eliminate the difference in temperature by integrating the error over time. See Figure 2-3d. An integral setting that is too low causes the load to take too long to reach the setpoint. An integral setting that is too high creates instability and causes the load temperature to oscillate.

Begin this part of the tuning process with the system controlling in proportional only mode. Use the oscillation period of the load that was measured above in seconds. *Divide 1000 by the period to get the integral setting.* Enter the integral setting into the Model 340 and watch the load temperature approach the setpoint. If the temperature does not stabilize and begins to oscillate around the setpoint, the integral setting is too high and should be reduced by one half. If the temperature is stable but never reaches the setpoint, the integral setting is too low and should be doubled.

To verify the integral setting make a few small (2 to 5 degree) changes in setpoint and watch the load temperature react. Trial and error can help improve the integral setting by optimizing for experimental needs. Faster integrals, for example, get to the setpoint more quickly at the expense of greater overshoot. In most systems, setpoint changes that raise the temperature act differently than changes that lower the temperature.

If it was not possible to measure the oscillation period of the load during proportional setting, start with an integral setting of 20. If the load becomes unstable, reduce the setting by half. If the load is stable, make a series of small, two to five degree, changes in the setpoint and watch the load react. Continue to increase the integral setting until the desired response is achieved.

2.7.4 Tuning Derivative

If an experiment requires frequent changes in setpoint or data taking between changes in the setpoint, derivative should be considered. See Figure 2-3e. A derivative setting of zero, off, is recommended when the control system is seldom changed and data is taken when the load is at steady state.

Compute a derivative setting in seconds as one fourth the measured oscillation period of the load in seconds. If this period is unknown and the integral setting was determined experimentally, the derivative setting in seconds is calculated as:

$$D_{\text{setting}} = \frac{1000}{4 \times I_{\text{setting}}}$$

Again, do not be afraid to make some small setpoint changes; halving or doubling this setting to watch the effect.

2.8 AUTOTUNING

Choosing appropriate PID control settings can be tedious. As systems may take several minutes to complete a setpoint change, it is difficult to observe the display for that length of time watching for oscillation periods or signs of instability. With the AutoTune feature, the Model 340 automates the tuning process by measuring system characteristics. Then, combined with assumptions about typical cryogenic systems, it computes setting values for P, I, and D. AutoTune works only with one control loop at a time and will not set manual heater output or heater range. Setting an inappropriate heater range is potentially dangerous to some loads so the Model 340 does not attempt to automate that step of the tuning process.

When AutoTune mode is selected, the Model 340 will evaluate the control loop similar to Manual Tuning (Paragraph 2.7). The major difference is the Model 340 will not initiate changes to the control settings or setpoint for the purpose of tuning. Since unexpected or unwanted disturbances to the control system can ruin experimental data being taken by the user, the Model 340 only gathers data and changes control settings after the user changes the setpoint.

When the user selects a new setpoint, the Model 340 logs the change in temperature at the load and the change in heater output that was required to make the load temperature change. The old control settings are used while data is being logged, so a good initial guess of settings can improve the efficiency of the AutoTune feature. Once the load temperature is at or near the new setpoint, the Model 340 looks at the logged data to calculate the best P, I, and D setting values. The values are then loaded and used as the control parameters so the control loop can stabilize at the new setpoint. AutoTune does not work during a ramp because the dominant time constant of the load is disguised by the ramp rate.

The user can tell when data is being logged because the **Tune** annunciator changes to **Tuning**. When the annunciator returns to **Tune**, the process is complete and will not begin again until the user changes the setpoint. If AutoTune does not give desired results the first time, make a few small (2 to 5 degree) changes in setpoint and let the Model 340 complete the tuning cycle each time. This allows the AutoTune feature to zero in on a better set of control settings.

There are situations where AutoTune is not the answer. The algorithm can be fooled when cooling systems are either very fast, very slow, have a large thermal lag, or have a nonlinear relationship between heater power and load temperature. If a load can reach a new setpoint in just under 10 seconds (with an appropriate I setting of >500), the cooling system is too fast for AutoTuning. Systems with a very small thermal mass can be this fast. Adding mass is a solution, but it is unappealing to users who need the speed for fast cycle times. Manual tuning is not difficult on these systems since new settings can be tested very quickly. Some systems are too slow for the AutoTune algorithm. Any system that takes more than 15 minutes to stabilize (with an appropriate I setting of <5) is too slow.

Thermal lag can be improved by using the sensor and heater installation techniques discussed in this chapter. Lag times of a few seconds should be expected; much larger lags can be a problem. System non-linearity is a problem for both AutoTune and manual tuning. It is most commonly noticed when controlling near the maximum or minimum temperature of a temperature control system. It is not uncommon, however, for a user to buy a cryogenic cooling system specifically to operate near its minimum temperature. If this is the case, try to tune the system at 5 degrees above the minimum temperature and gradually reduce the setpoint, manually adjusting the control settings with each step. Any time the mechanical cooling action of a cryogenic refrigerator can be seen as a periodic temperature fluctuation, the mass is too small or temperature too low to AutoTune.

2.9 ZONE TUNING

Once the PID tuning parameters have been chosen for a given setpoint the whole process may have to be done again for other setpoints significantly far away that have different tuning needs. Trying to remember when to use which set of tuning parameters can be frustrating. The Model 340 has a Zone feature as one of its tuning modes that can help.

To use the Zone feature the user must determine the best tuning parameters for each part of the temperature range of interest. These parameters are then entered into the Model 340 where up to ten zones can be defined with different P, I, D, heater range and manual output. A setpoint setting is assigned as the maximum temperature for that zone. The minimum temperature for a zone is the setpoint for the previous zone, 0 K is the starting point for the first zone. When the zone tuning mode is on, appropriate control parameters are chosen automatically, each time the setpoint is changed to a new temperature zone.

Control parameters can be determined manually or by using the AutoTune feature. AutoTune is a good way to determine a set of tuning parameters for the control system that can then be entered as zones. Once the parameters are chosen, AutoTune is turned off and zone tuning takes over.

CHAPTER 3

INSTALLATION

3.0 GENERAL

This chapter provides a general layout for the Model 340 rear panel and information on how to make line power, sensor, heater, and interface connections to the Model 340. Refer to Chapter 2 for cooling system wiring. To experiment with software settings covered in the next chapter before doing a complete hardware setup, the Model 340 can be powered with only line power connected.

CAUTION: Before plugging in the Model 340 and turning it on, read Paragraph 3.3 on line voltage settings. An improper line voltage setting may damage the Model 340; check it carefully before powering the instrument for the first time.

This chapter covers receiving the Model 340 in Paragraph 3.1, rear panel control definitions in Paragraph 3.2, power line input assembly in Paragraph 3.3, hooking up standard sensor inputs in Paragraph 3.4, heater output setup in Paragraph 3.5, analog outputs in Paragraph 3.6, digital inputs and outputs in Paragraph 3.7, and relays in Paragraph 3.8.

3.1 RECEIVING THE MODEL 340

This section covers inspection and unpacking in Paragraph 3.1.1, repackaging for shipment in Paragraph 3.1.2, environmental requirements in Paragraph 3.1.3, safety summary in Paragraph 3.1.4, safety symbols in Paragraph 3.1.5, and handling liquid helium and liquid nitrogen in Paragraph 3.1.6.

3.1.1 Inspection and Unpacking

Inspect shipping containers for external damage. All claims for damage (apparent or concealed) or partial loss of shipment must be made in writing to Lake Shore within five (5) days from receipt of goods. If damage or loss is apparent, please notify the shipping agent immediately.

Open the shipping containers. A packing list is included with the system to simplify checking that the instrument, sensor, accessories, and manual were received. Please use the packing list and the spaces provided to check off each item as the instrument is unpacked. Inspect for damage. Be sure to inventory all components supplied before discarding any shipping materials. If there is damage to the instrument in transit, be sure to file proper claims promptly with the carrier and insurance company. Please inform Lake Shore of such filings. In case of parts or accessory shortages, advise Lake Shore immediately. Lake Shore cannot be responsible for any missing parts unless notified within 60 days of shipment. The standard Lake Shore Warranty is included on the A Page (immediately behind the title page) of this manual.

3.1.2 Repackaging For Shipment

To return the Model 340, sensor, or accessories for repair or replacement, obtain a Return Goods Authorization (RGA) number from Technical Service in the United States, or from the authorized sales/service representative from which the product was purchased. Instruments may not be accepted without a RGA number. When returning an instrument for service, Lake Shore must have the following information before attempting any repair.

1. Instrument model and serial number.
2. User name, company, address, and phone number.
3. Malfunction symptoms.
4. Description of system.
5. Returned Goods Authorization (RGA) number.
6. Softer Version Master Input Options

Wrap instrument in a protective bag and use original spacers to protect controls. Repack the system in the Lake Shore shipping carton (if available) and seal it with strong paper or nylon tape. Affix shipping labels and FRAGILE warnings. Write the RGA number on the outside of the shipping container or on the packing slip.

3.1.3 Safety Summary

The following general safety precautions must be observed during all phases of operation, service, and repair of this instrument. Failure to comply with these precautions or with specific warnings elsewhere in this manual violates safety standards of design, manufacture, and intended use of the instrument. Lake Shore Cryotronics, Inc. assumes no liability for Customer failure to comply with these requirements.

The Model 340 protects the operator and surrounding area from electric shock or burn, mechanical hazards, excessive temperature, and spread of fire from the instrument. Environmental conditions outside of the conditions below may pose a hazard to the operator and surrounding area.

- Temperature: 5 °C to 40 °C.
- Maximum relative humidity: 80% for temperature up to 31 °C decreasing linearly to 50% at 40 °C.
- Power supply voltage fluctuations not to exceed ±10% of the nominal voltage.

Ground the Instrument

To minimize shock hazard, the instrument chassis and cabinet must be connected to an electrical ground. The instrument is equipped with a three-conductor AC power cable. The power cable must either be plugged into an approved three-contact electrical outlet or used with a three-contact adapter with the grounding wire (green) firmly connected to an electrical ground (safety ground) at the power outlet. The power jack and mating plug of the power cable meet Underwriters Laboratories (UL) and International Electrotechnical Commission (IEC) safety standards.

Do Not Operate in an Explosive Atmosphere

Do not operate the instrument in the presence of flammable gases or fumes. Operation of any electrical instrument in such an environment constitutes a definite safety hazard.













Keep Away from Live Circuits

Operating personnel must not remove instrument covers. Component replacement and internal adjustments must be made by qualified maintenance personnel. Do not replace components with power cable connected. To avoid injuries, always disconnect power and discharge circuits before touching them.

Do Not Substitute Parts or Modify Instrument

Because of the danger of introducing additional hazards, do not install substitute parts or perform any unauthorized modification to the instrument. Return the instrument to an authorized Lake Shore representative for service and repair to ensure that safety features are maintained.

3.1.4 Safety Symbols

	Direct current (power line).		Equipment protected throughout by double insulation or reinforced insulation (equivalent to Class II of IEC 536 - see Annex H).
	Alternating current (power line).		Caution: High voltages; danger of electric shock. Background color: Yellow; Symbol and outline: Black.
	Alternating or direct current (power line).		Caution or Warning - See instrument documentation. Background color: Yellow; Symbol and outline: Black.
	Three-phase alternating current (power line).		Fuse.
	Earth (ground) terminal.		
	Protective conductor terminal.		
	Frame or chassis terminal.		
	On (supply).		
	Off (supply).		

3.1.5 Handling Liquid Helium and Liquid Nitrogen

Liquid Helium (LHe) and liquid nitrogen (LN₂) may be used in conjunction with the Model 340. Although not explosive, the following paragraphs provide safety considerations in the handling of LHe and LN₂.

3.1.5.1 Properties

LHe and LN₂ are colorless, odorless, and tasteless gases. Gaseous nitrogen makes up about 78% of Earth's atmosphere, while helium comprises only about 5 ppm. Most helium is recovered from natural gas deposits. Once collected and isolated, the gases liquefy when properly cooled. A quick comparison between LHe and LN₂ is provided in Table 3-1.

Table 3-1. Comparison of Liquid Helium to Liquid Nitrogen

PROPERTY	LIQUID HELIUM	LIQUID NITROGEN
Boiling Point @1 atm, in K	4.2	77.35
Thermal Conductivity (Gas), w/cm-K	0.083	0.013
Latent Heat of Vaporization, Btu/liter	2.4	152
Liquid Density, pounds/liter	0.275	0.78

3.1.5.2 Handling Cryogenic Storage Dewars

All cryogenic containers (dewars) must be operated in accordance with instructions from the manufacturer. Safety instructions are normally posted on the side of each dewar. Cryogenic dewars must be kept in a well-ventilated place where they are protected from the weather and away from any sources of heat. A typical cryogenic dewar is shown in Figure 3-1.

3.1.5.3 Liquid Helium and Nitrogen Safety Precautions

Transferring LHe and LN₂ and operation of the storage dewar controls should be in accordance with instructions from the manufacturer/supplier. During this transfer, it is important that all safety precautions written on the storage dewar and recommended by the manufacturer be followed.

WARNING

- **Liquid helium and liquid nitrogen are potential asphyxiants and can cause rapid suffocation without warning. Store and use in area with adequate ventilation. DO NOT vent container in confined spaces. DO NOT enter confined spaces where gas may be present unless area has been well ventilated. If inhaled, remove to fresh air. If not breathing, give artificial respiration. If breathing is difficult, give oxygen. Get medical help.**
- **Liquid helium and liquid nitrogen can cause severe frostbite to the eyes or skin. DO NOT touch frosted pipes or valves. In case of frostbite, consult a physician at once. If a physician is not readily available, warm the affected areas with water that is near body temperature.**

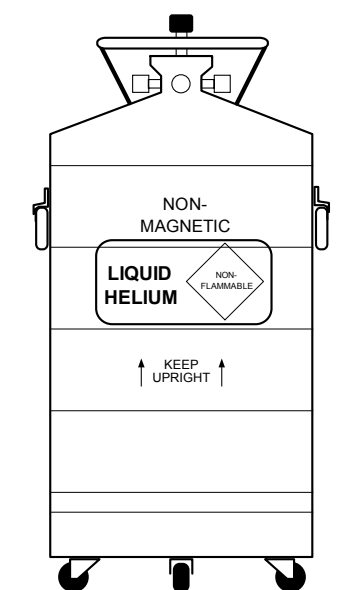

Figure 3-1. Typical Cryogenic Storage Dewar

The two most important safety aspects to consider when handling LHe and LN₂ are adequate ventilation and eye and skin protection. Although helium and nitrogen gases are non-toxic, they are dangerous in that they replace the air in a normal breathing atmosphere. Liquid products are of an even greater threat since a small amount of liquid evaporates to create a large amount of gas. Therefore, it is imperative that cryogenic dewars be stored, transfers accomplished, and systems operated in open and well ventilated areas.

Persons transferring LHe and LN₂ should make every effort to protect eyes and skin from accidental contact with liquid or the cold gas issuing from it. Protect your eyes with full face shield or chemical splash goggles. Safety glasses (even with side shields) are not adequate. Always wear special cryogenic gloves (Tempshield Cryo-Gloves® or equivalent) when handling anything that is, or may have been, in contact with the liquid or cold gas, or with cold pipes or equipment. Long sleeve shirts and cuffless trousers that are of sufficient length to prevent liquid from entering the shoes are recommended.

3.1.5.4 Recommended First Aid

Every site that stores and uses LHe and LN₂ should have an appropriate Material Safety Data Sheet (MSDS) present. The MSDS may be obtained from the manufacturer/distributor. The MSDS specifies the symptoms of overexposure and the first aid to be used. A typical summary of these instructions is provided as follows.

If symptoms of asphyxia such as headache, drowsiness, dizziness, excitation, excess salivation, vomiting, or unconsciousness are observed, remove the victim to fresh air. If breathing is difficult, give oxygen. If breathing has stopped, give artificial respiration. Call a physician immediately.

If exposure to cryogenic liquids or cold gases occurs, restore tissue to normal body temperature (98.6 °F) as rapidly as possible, then protect the injured tissue from further damage and infection. Call a physician immediately. Rapid warming of the affected parts is best achieved by bathing it in warm water. The water temperature should not exceed 105 °F (40 °C), and under no circumstances should the frozen part be rubbed, either before or after rewarming. If the eyes are involved, flush them thoroughly with warm water for at least 15 minutes. In case of massive exposure, remove clothing while showering with warm water. The patient should not drink alcohol or smoke. Keep warm and rest. Call a physician immediately.

3.2 REAR PANEL DEFINITION

This paragraph provides a summary of Model 340 rear panel connections. See Figure 3-2.

CAUTION

- **Verify that the AC Line Voltage shown in the window on the fuse holder corresponds to that marked on the rear panel, and that both these settings are appropriate for the intended AC power input. Also remove and verify the proper fuse is installed before inserting the power cord and turning on the instrument.**
- **Always turn off the instrument before making any rear panel connections. This is especially critical when making sensor to instrument connections.**

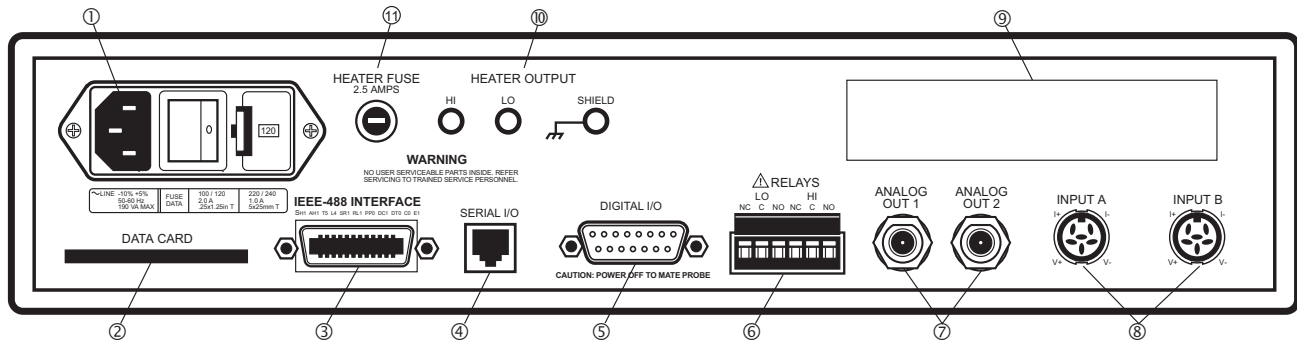

- | | | |
|-----|---|---------------------------------|
| 1. | Line Input Assembly | Paragraph 3.3 |
| 2. | DATA CARD Slot..... | Paragraph 8.4 |
| 3. | IEEE-488 INTERFACE Connector | Paragraph 9.1 and Figure 10-8 |
| 4. | SERIAL I/O Connector | Paragraph 9.2 and Figure 10-2 |
| 5. | DIGITAL I/O Connector | Paragraph 3.7 and Paragraph 7.2 |
| 6. | RELAYS LO and HI Connector | Paragraph 3.8 |
| 7. | ANALOG OUT 1 and 2 Connectors | Paragraph 3.6 and Paragraph 7.1 |
| 8. | Sensor INPUT A and B Connectors..... | Paragraph 3.4 |
| 9. | Option Cutout | Paragraph 11.1 |
| 10. | Loop 1 HEATER OUTPUT Banana Jacks | Paragraph 3.5 |
| 11. | Loop 1 HEATER FUSE | Paragraph 3.5.4 |

Figure 3-2. Model 340 Rear Panel

3.3 Line Input Assembly

This section describes how to properly connect the Model 340 to line power. Please follow these instructions carefully to ensure proper operation of the instrument and the safety of operators.

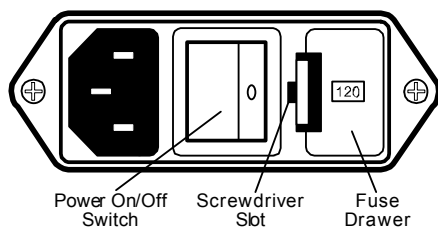

Figure 3-3. Line Input Assembly

Depending upon the date of manufacture, the unit will have either of two fuse data legends printed under the Line Input Assembly:

 LINE -10% +5% 50-60 Hz 190 VA MAX	FUSE DATA	100 / 120 2.0 A .25x1.25in T	220 / 240 1.0 A 5x20mm T
	FUSE DATA	100 / 120 2.0 A 5x20mm T	220 / 240 1.0 A 5x20mm T

Figure 3-4. Fuse Data Legends

Only the dimensions of the 2 A fuse change; the rating does not.

Line voltage is discussed in Paragraph 3.3.1. Fuse verification is discussed in Paragraph 3.3.2. The power cord is discussed in Paragraph 3.3.3. The power switch is identified in Paragraph 3.3.4.

3.3.1 Line Voltage

The line input assembly contains the line voltage selector, line fuse holder, and power cord connector. It is important to verify that the Model 340 is set to the appropriate line voltage and has the correct line fuse before it is powered on for the first time. Refer to Table 3-2. If the final destination of the instrument is known when it is shipped, the line input is configured at the factory. This configuration should always be checked because it is not unusual for an instrument to change hands before it reaches the end user. All of the line voltages discussed are single phase.

Table 3-2 AC Line Input Definitions

Indicator	Line Voltage Range	Fuse (slow blow)
100	90-105 VAC	2 A
120	108-126 VAC	2 A
220	198-231 VAC	1 A
240	216-252 VAC	1 A

To verify the proper line voltage selection look at the indicator in the window of the line input assembly. Line voltage should be in the range shown in Table 3-2 for that indicator. If it is not, change the line voltage selector as described in Paragraph 11.3.3.

3.3.2 Line Fuse and Fuse Holder

The line fuse is an important safety feature of the Model 340. If a fuse ever fails, it is important to replace it with the value and type indicated on the rear panel for the line voltage setting. The letter "T" on the fuse rating indicates that the instrument requires a time-delay or slow-blow fuse. Fuse values should be verified any time line voltage configuration is changed. Instructions for changing and verifying a line fuse are given in Paragraph 11.3.

3.3.3 Power Cord

The Model 340 includes a three-conductor power cord. Line voltage travels across the outer two conductors. The center conductor is a safety ground and connects to the instrument metal chassis when the power cord attaches to the power connector. For safety, plug the cord into an appropriate *grounded* receptacle.

3.3.4 Power Switch

The power switch turns the instrument ON and OFF and is located in the line input assembly on the instrument rear. When **I** is raised on the switch, the instrument is ON; when **O** is raised, the instrument is OFF. Do not remove instrument covers without first disconnecting the power cord, even if the instrument power switch is off.

3.4 STANDARD SENSOR INPUTS

This paragraph details how to connect sensors to the standard Model 340 inputs. These inputs operate with most resistive and diode sensors. Refer to Paragraph 5.1 to configure inputs for a sensor type with software. Some sensor types require an optional input, which is discussed in Chapter 10.

This section covers sensor input connector and pinout in Paragraph 3.4.1, sensor lead cable in Paragraph 3.4.2, grounding and shielding sensor leads in Paragraph 3.4.3, sensor polarity in Paragraph 3.4.4, four-lead sensor measurement in Paragraph 3.4.5, two-lead sensor measurement in Paragraph 3.4.6, and lowering measurement noise in Paragraph 3.4.7.

3.4.1 Sensor Input Connector and Pinout

The input connectors are 6-pin DIN 45322 sockets. The sensor output pins are defined in Table 3-3. Two mating connectors (6-pin DIN plugs) are included in the connector kit shipped with the instrument. These are common connectors, so additional mating connectors can be purchased from local electronics suppliers. They can also be ordered from Lake Shore (P/N G-106-233).

Table 3-3. Sensor INPUT A and B Connector Definition

Pin	Symbol	Description
1	I-	Minus Current Terminal
2	V-	Minus Voltage Terminal
3	Shield	Driven Shield or Guard
4	V+	Plus Voltage Terminal
5	I+	Plus Current Terminal
6		No Connection

this is looking at back of 340 controller

INPUT A

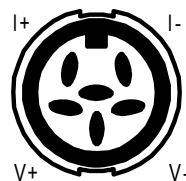

INPUT B

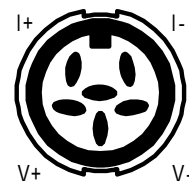

3.4.2 Sensor Lead Cable

The sensor lead cable used outside the cooling system can be much different form what is used inside. Between the instrument and vacuum shroud, error and noise pick up need to be minimized, not heat leak. Larger conductor, 22 to 28 AWG stranded copper wire is recommended because it has low resistance yet remains flexible when several wires are bundled in a cable. The arrangement of wires in a cable is also important. For best results, voltage leads, V+ and V- should be twisted together and current leads I+ and I- should be twisted together. The twisted pairs of voltage and current leads should then be covered with a braided or foil shield which is connected to the driven shield pin of the instrument. This type of cable is

available through local electronics suppliers. Instrument specifications are given assuming 10 feet of sensor cable. Longer cables, 100 feet or more, can be used but environmental conditions may degrade accuracy and noise specifications.

3.4.3 Grounding and Shielding Sensor Leads

The sensor input measurements are isolated from earth ground to reduce the amount of earth ground referenced noise that is present on the measurement leads. This isolation can be defeated by connecting sensor leads to earth ground on the chassis of the instrument or in the cooling system. If one sensor lead must be grounded, ground only one lead and ground it in only one place. Grounding leads on more than one sensor prevents the sensor excitation current sources from operating.

Shielding the sensor lead cable is important to keep external noise from entering the measurement. A shield is most effective when it is near the measurement potential so the Model 340 offers a driven shield that stays close to the measurement. The shield of the sensor cable should be connected to the shield pin of the input connector. It should not be terminated at the opposite end of the cable. The shield should not be connected to earth ground on the instrument chassis or in the cooling system.

NOTE: The shell of the connector is in contact with the chassis so the cable shield should never touch the outer shell of the connector.

The shield pin of the Model 340 input connector can be connected to the shield drive or the measurement ground. The shield drive is recommended for cables over 20 feet in length. To change the shield pin contact, use JMP6 for Input B and JMP5 for Input A. See Figure 11-11.

I think this should be Fig. 11-13. In any event, doesn't look something a user should do!

3.4.4 Sensor Polarity

Lake Shore sensors are shipped with instructions that indicate which sensor leads are which. It is important to follow these instructions for plus and minus leads (polarity) as well as voltage and current when applicable. Diode sensors do not operate in the wrong polarity. They look like an open circuit to the instrument. Two lead resistors can operate with any lead arrangement and the sensor instructions may not specify. Four-lead resistors can be more dependent on lead arrangement. Follow any specified lead assignment for four lead resistors. Mixing leads could give a reading that appears correct but is not the most accurate.

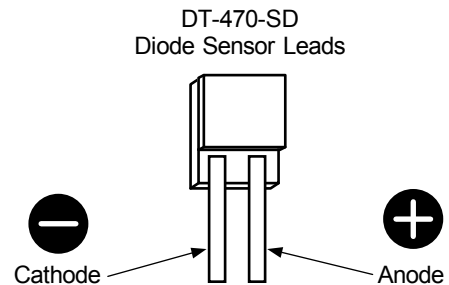

3.4.5 Four-Lead Sensor Measurement

All sensors, including both two lead and four lead can be measured with a four lead technique. The purpose of a four lead measurement is to eliminate the effect of lead resistance on the measurement. If it is not taken out, lead resistance is a direct error when measuring a resistive sensor.

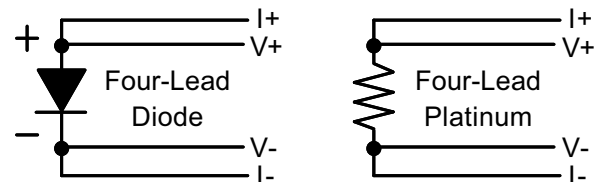

In a four lead measurement, current leads and voltage leads are run separately up to the sensor. With separate leads there is little current in the voltage leads so their resistance does not enter into the measurement. Resistance in the current leads will not change the current as long as the voltage compliance of the current source is not reached. When two lead sensors are used in four lead measurements, the short leads on the sensor have an insignificant resistance.

3.4.6 Two-Lead Sensor Measurement

There are times when crowding in a cryogenic system forces users to read sensors in a two lead configuration because there are not enough feedthroughs or room for lead wires. If this is the case, plus voltage to plus current and minus voltage to minus current leads are attached at the back of the instrument or at the vacuum feedthrough.

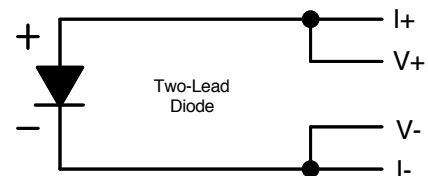

The error in a resistive measurement is the resistance of the lead wire run with current and voltage together. If the leads contribute 2 or 3 Ω to a 10 kΩ reading, the error can

probably be tolerated. When measuring voltage for diode sensors the error in voltage can be calculated as the lead resistance times the current, typically 10 μ A. For example: a 10 Ω lead resistance times 10 μ A results in a 0.1 mV error in voltage. Given the sensitivity of a silicon diode at 4.2 K the error in temperature would be only 3 mK. At 77 K the sensitivity of a silicon diode is lower so the error would be close to 50 mK. Again, this may not be a problem for every user.

3.4.7 Lowering Measurement Noise

Good instrument hardware setup technique is one of the least expensive ways to reduce measurement noise. The suggestions fall into two categories: (1) Do not let noise from the outside enter into the measurement, and (2) Let the instrument isolation and other hardware features work to their best advantage.

- Use four lead measurement whenever possible.
- Do not connect sensor leads to chassis or earth ground.
- If sensor leads must be grounded, ground leads on only one sensor.
- Use twisted shielded cable outside the cooling system.
- Attach the shield pin on the sensor connector to the cable shield.
- Do not attach the cable shield at the other end of the cable, not even to ground.
- Run different inputs and outputs in their own shielded cable.
- Use twisted wire inside the cooling system.
- Use similar technique for heater leads.
- Use a grounded receptacle for the instrument power cord.
- Consider ground strapping the instrument chassis to other instruments or computers.

3.5 HEATER OUTPUT SETUP

The following paragraphs cover the heater wiring from the vacuum shroud to the instrument for both control loop outputs. Software settings and limit configuration of the heater output are detailed in Paragraph 6.12.1. For information on choosing and installing an appropriate resistive heater, refer to the Paragraph 2.4.

Loop 1 output is discussed in Paragraph 3.5.1. Heater output connector for Loop 1 is discussed in Paragraph 3.5.2. Heater output wiring for Loop 1 is discussed in Paragraph 3.5.3. Heater protection and fuse for loop is discussed in Paragraph 3.5.4. Noise on Loop 1 heater leads is discussed in Paragraph 3.5.5. The Lake Shore Model 3003 Heater Output Conditioner is discussed in Paragraph 3.5.6. The Loop 2 output is discussed in Paragraph 3.5.7. Loop 2 output resistance is discussed in Paragraph 3.5.8. The Loop 2 output connector is discussed in Paragraph 3.5.9. Loop 2 heater protection is discussed in Paragraph 3.5.10. Finally, boosting the output power is discussed in Paragraph 3.5.11.

3.5.1 Loop 1 Output

The Model 340 has two control loops. Loop 1 can be considered a primary loop because it is capable of driving 100 W of heater power. The heater output for Loop 1 is a traditional control output for a cryogenic temperature controller. It is a variable DC current source with several software settable ranges and limits. The maximum heater output current is 2 A and maximum compliance voltage is 50 V.

3.5.2 Heater Output Connector for Loop 1

A dual banana jack on the rear panel of the instrument is used for connecting wires to the Loop 1 heater. A standard dual banana plug mating connector is included in the connector kit shipped with the instrument. This is a common jack and additional mating connectors can be purchased from local electronic suppliers. They can also be purchased from Lake Shore (P/N 106-009).

3.5.3 Heater Output Wiring for Loop 1

Heater output current is what determines the size (gauge) of wire needed to connect the heater. The maximum current that can be sourced from the Loop 1 heater output is 2 A. When less current is needed to power a cooling system it can be limited in software with range settings. The load can be protected against catastrophic instrument failure with heater fuse described below.

When setting up a temperature control system it is recommended that the lead wire for the heater be capable of carrying a continuous current that is greater than the maximum current or heater fuse rating. Wire

manufacturers recommend 26 AWG or larger wire to carry 2 A of current, but there is little advantage in using wire smaller than 20 to 22 AWG.

It is recommended to use twisted, shielded cable for heater leads. Large changes in heater current can induce noise in measurement leads and twisting reduces the effect. It is also recommended to run heater leads in a separate cable from the measurement leads to further reduce interaction. There is a chassis ground point at the rear panel of the instrument for shielding the heater cable. The cable shield can be tied to this point with a single banana plug. The shield should not be connected at the opposite end of the cable.

The Loop 1 heater output is isolated from chassis ground to reduce noise. For best noise performance, do not connect the resistive heater or its leads to ground. Also avoid connecting heater leads to sensor leads or any other instrument inputs or outputs.

3.5.4 Heater Protection and Fuse for Loop 1

The heater output of the Model 340 is a current source and has protection that prevents it from being damaged even if shorted. The heater fuse on the rear panel of the instrument is there to provide one more level of protection for delicate cooling systems. A fuse is a current limiting device, it burns out if too much current is passed through it. Some systems require little heater power, which requires only a small amount of current. Even though the Model 340 has software current limits, the user may wish to put a smaller fuse into the heater fuse holder to protect against inadvertent changes in instrument settings.

The heater fuse is shipped from the factory with a 2.5 A, $\frac{1}{4} \times 1\frac{1}{4}$ inch fuse. This fuse can be replaced with a value less than 2.5 A but should never be replaced with a higher value.

3.5.5 Loop 1 Heater Noise

The heater output circuitry in the Model 340 must be capable of sourcing 100 W of power. This type of circuitry can generate some excess electrical noise. The Model 340 was designed to generate as little noise as possible but even noise that is a small percentage of the output voltage or current can be too much when sensitive measurements are being made near by. If the Model 340 heater leads are too noisy and the above wiring techniques do not help, Lake Shore offers the Model 3003 Heater Output Conditioner that may help.

3.5.6 Model 3003 Heater Output Conditioner

The Lake Shore Model 3003 heater output conditioner is a passive filter that reduces the already low noise present in the heater output of the Model 340. The Model 3003 connects between the heater output terminals on the rear panel of a controller and a resistive heater. See Figure 3-5. Specifications are as follows:

Max Current: 2 A

Max Voltage: 60 V

Attenuation: 50 or 60 Hz. (line frequency): 20 dB
100 Hz. and above (line frequency harmonics): 40 dB

Size: 144 mm wide \times 72 mm long \times 165 mm deep (5.7 \times 2.8 \times 6.5 inches)

Weight: 1.6 kilograms (3.5 pounds)

The Model 3003 is a passive filter and requires no external power supply. The **High** and **Low** terminals on the controller must be connected to the **High** and **Low** terminals marked *From Controller* on the Model 3003. The binding posts or a dual banana plug can be used to connect to the model 3003. Precautions must be taken to ensure the High and Low terminals are not reversed. A diode in the Model 3003 shorts the heater output if the polarity of the terminals is reversed.

The **High** and **Low** terminals marked *To Heater*

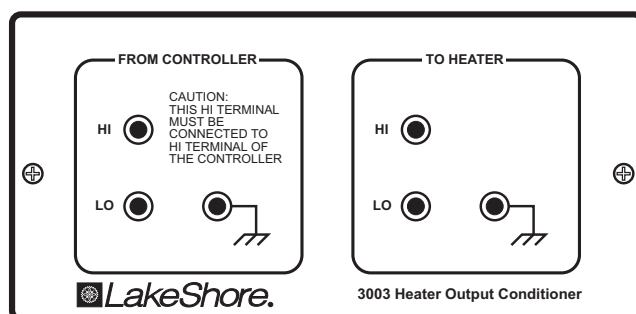

Figure 3-5. Model 3003 Heater Output Conditioner

on the Model 3003 should be attached to a resistive heater used for temperature control. The binding posts or a dual banana plug can be used to connect to the Model 3003. The ground terminals on the Model 3003 continue the shield if the heater cable is shielded.

3.5.7 Loop 2 Output

The Model 340 has a second control loop called Loop 2. Loop 2 is an auxiliary control loop with enough features to control a radiation shield or small sample heater. Loop 2 has a different output from Loop 1, it uses Analog Output 2 as its actuator. It is a variable DC voltage source that can vary from -10 V to +10 V. The resolution of the analog output is 1.25 mV or 0.0125% of full scale. The output can source up to 100 mA of current providing a maximum of 1 W of heater power.

3.5.8 Loop 2 Output Resistance

The power delivered by the Loop 2 output is calculated as: $P = \frac{V^2}{R_{heater}}$

The output is rated for no more than 100 mA of current, so for the maximum of 1 W output power use a 100 Ω resistive heater with a power rating greater than 1 W. Smaller resistance values should not be used, but larger resistances can be used for lower power applications.

3.5.9 Loop 2 Output Connector

The connector for Loop 2 output, which is Analog Output 2, is a BNC connector. The inner conductor is the output voltage terminal, the outer conductor is attached to chassis ground inside the instrument. A coaxial cable with attached BNC terminal is recommended for this output. The center conductor is capable of carrying the maximum current and the outer conductor acts as a shield. Attaching the outer conductor to ground at the opposite end of the cable is not recommended. These connectors are not included with the Model 340 but are available from local electronic suppliers.

3.5.10 Loop 2 Heater Protection

The output is short protected so the instrument is not harmed if the heater resistance is too small. It is not recommended because the additional load on instrument power supplies causes noise on internal circuits. The second control loop has fewer features than the first including software protection and limits. The user must be careful to build a robust system and account for the voltage range and power-up state of the control output.

3.5.11 Boosting the Output Power

There are temperature control systems that require more power than the Model 340 can provide. An auxiliary DC power supply can be used to boost the output of the Model 340. Programmable power supplies are available that use a low current programming voltage as an input to control a high current voltage output. Analog output 2, used for Loop 2 output, provides an ideal programming voltage for an auxiliary power supply.

The only drawback with using the analog output to program auxiliary supplies is it only has one voltage range. The heater output for Loop 1 has several ranges that can improve resolution, but its output is in current not voltage. A programming resistor can be placed across the heater output to produce a programming voltage. The programming voltage is related to output current by: $V_{program} = R_{program} \times I_{output}$

The resistor must be chosen to convert a full scale current from the highest heater output range being used to the full scale programming voltage of the auxiliary supply. For example, if the auxiliary supply has a full scale programming voltage of 10 V and the maximum current for the highest heater output range being used is 0.25 A the programming resistor should be $10 \text{ V} / 0.25 \text{ A} = 40 \Omega$. The programming resistor must be rated for the power being dissipated in it which is $Power = I_{output}^2 \times R_{program}$ or 2.5 W. Lower heater output current ranges can be selected to reduce the power dissipated in the programming resistor.

3.6 ANALOG OUTPUTS

Analog Output 1 and Analog Output 2 on the rear panel of the Model 340 are voltage outputs that can be used for monitor and control applications. See Figure 3-6. Their most basic function is a temperature monitor where they put out a voltage that is proportional to temperature. They can be configured to monitor the output of a linear equation which allows the user to select an offset and gain. ANALOG OUT 2 can be used as the control output for Loop 2. The analog outputs can also be controlled manually by the user for any application that requires a programmable voltage source.

Both analog outputs are variable DC voltage sources that can vary from -10 V to +10 V. The resolution of the analog output is 1.25 mV or 0.0125% of full scale. The output can source up to 100 mA of current providing a maximum of 1 W of power. They can drive a resistive load of no less than 100 Ω . The output is short protected so the instrument is not harmed if the heater resistance is too small. It is not recommended because the additional load on instrument power supplies causes noise on internal circuits.

The connectors for the analog outputs are BNC sockets. The inner conductor is the output voltage terminal, the outer conductor is the outputs ground and is attached to chassis ground inside the instrument. A coaxial cable with attached BNC plug is recommended for this output. These connectors are not included with the Model 340 but are available from local electronic suppliers.

It is not recommended to attach the analog output ground to a ground outside the instrument. The output should be read by an instrument with an isolated or differential input wherever possible. Connecting to an external ground can cause noise in the analog output voltage or the sensor input measurement. If this cannot be avoided, try to keep the chassis of the two instruments at the same potential with a ground strap.

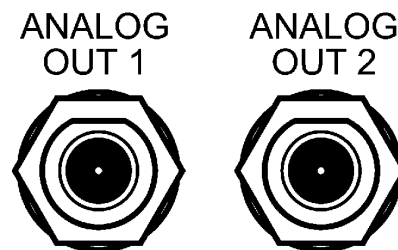

PIN	DESCRIPTION
1	Analog Output, Center Conductor
2	Ground, Connector Shell

Figure 3-6. ANALOG OUT 1 and 2 BNC Rear Panel Connector Details

3.7 DIGITAL I/O

The connector labeled Digital I/O on the rear panel of the Model 340 has terminal pins with digital inputs and outputs along with power supplies. See Figure 3-7. The digital inputs and outputs can be used to in applications that involve auxiliary sensor input scanners. These signals can also be used in manual mode to control and monitor external events. The power supplies are provided for external circuit applications that require low current.

The digital inputs and outputs are Transistor-to-Transistor Logic (TTL) voltage level compatible. They are protected against short circuit and over voltage, but it is not recommended to expose the terminals to electrostatic discharge (ESD), voltages higher than 5 volts, or lower than ground. Using more current than the limits in Figure 3-6 is not recommended because the additional load on instrument power supplies causes noise on internal circuits. All signals and power supplies should be returned to the ground pin whenever possible. Even though the ground pin is connected to chassis ground inside the Model 340, attaching the ground pin to external grounds can cause noise on the sensor input measurements.

The connector is a 15 pin D-style socket. This is a common socket (P/N 268-303) and mating plug (P/N 268-301) can be purchased from Lake Shore or any local electronic supplier.

3.8 RELAYS

The Model 340 has one high and one low relay, shown in Figure 3-8. They are most commonly associated with the alarm feature. The relays can also be put in manual mode and controlled directly by the user from the front panel or over computer interface. Refer to Paragraph 7.4. The relay status indicated on the relays and beeper screen is for monitoring the relay status. It cannot be set by the user. If a relay is inactive (Off), it will be in its normal state of open or closed. When the relay is active (On), it will be in the opposite state.

The relay outputs have a detachable 6-pin terminal block connector. The connector can be removed from its socket for convenient installation of wires. The connector is included with the Model 340 (P/N 106-737). The connector manufacturer indicates that up to 12 AWG stranded copper wire can be used with the connector. It is unlikely that wire that large will be required to carry the rated 2 amp current of the relay.

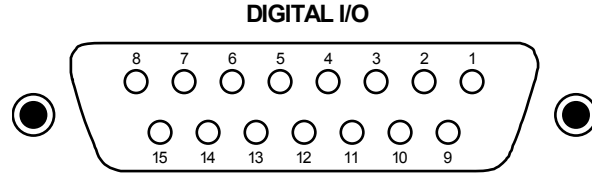

Pin	Symbol	Description	Type or Limit
1	DO1	Digital Output 1	TTL Output
2	DO2	Digital Output 2	TTL Output
3	DO3	Digital Output 3	TTL Output
4	DO4	Digital Output 4	TTL Output
5	DO5	Digital Output 5	TTL Output
6	Reserved/DI6	Acting as Digital Input 6	TTL Input
7	+5 V	+5 Volts Output	100 mA max
8	+15 V	+15 Volts Output	50 mA max
9	DI1	Digital Input 1	TTL Input
10	DI2	Digital Input 2	TTL Input
11	DI3	Digital Input 3	TTL Input
12	DI4	Digital Input 4	TTL Input
13	DI5	Digital Input 5	TTL Input
14	-15 V	-15 Volt Output	50 mA max
15	Gnd	Ground	-

Figure 3-7. DIGITAL I/O DA-15 Rear Panel Connector Details

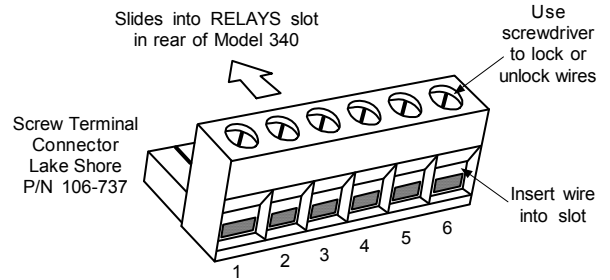

PIN	DESCRIPTION
1	Low, Normally Closed (N.C.)
2	Low, Common
3	Low, Normally Open (N.O.)
4	High, Normally Closed (N.C.)
5	High, Common
6	High, Normally Open (N.O.)

Figure 3-8 RELAYS LO and HI Rear Panel Connector Details

CHAPTER 4

FRONT PANEL OPERATION

4.0 GENERAL

This chapter covers turning power on in Paragraph 4.1, display formats in Paragraph 4.2, keyboard description in Paragraph 4.3, keypad navigation in Paragraph 4.4, and changing display format in Paragraph 4.5. Be sure to read Paragraph 3.3 on line voltage verification before proceeding.

4.1 TURNING POWER ON

Once the line voltage setting has been verified (Paragraph 3.3), plug the instrument end of the line cord (included in the connector kit) into the back of the instrument. Then plug the opposite end of the cord into a properly grounded, three-prong receptacle. Place the power switch, located next to the line cord connector, to the On position. The display backlight will brighten the display area and a Lake Shore graphic logo will appear on the display. The alarm beeper will sound once and the instrument will show a display of sensor readings and control settings.

There are several types of feedback that may be present at this time. Some indicate a problem with the instrument and others indicate the need for the user to setup the sensor inputs or control loops. Problems are indicated by the following:

- The display backlight does not turn on (backlight is dim indicating a cold instrument).
- The display does not show a logo or change from the logo.
- An error window appears with a message about a hardware problem. Refer to Paragraph 11.9.
- The alarm beeper does not sound.
- Instrument does not respond to keys being pressed.

If any of these symptoms are observed, please contact the factory.

Messages that indicate the need for further setup are common when first powering up the unit because many users do not have temperature sensors installed or sensor type selected. Do not be concerned if the following appear: **overload condition**, **no sensor attached**, **no temperature response curve selected**, or words indicating a problem with the heater configuration in the area of the display that normally shows heater output. These conditions will be resolved as instrument setup is completed.

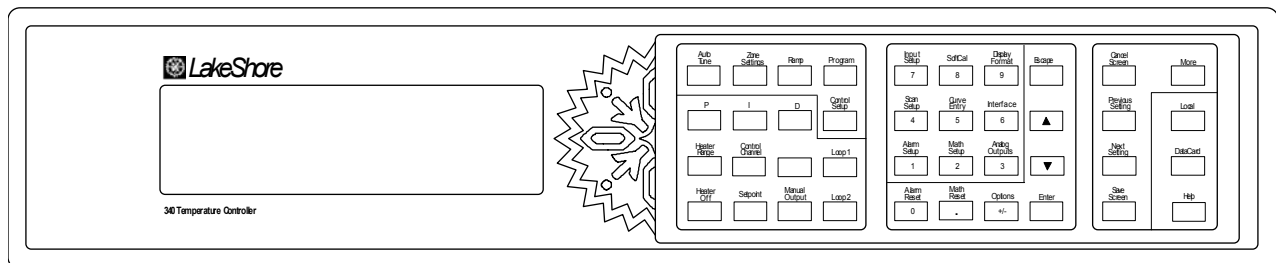

340-1-1.eps

Figure 4-1. Model 340 Front Panel

4.2 DISPLAY FORMATS

The Model 340 has an eight line by 40 character LCD graphic display capable of showing small (6 × 8) and large (12 × 16) characters. This display is very flexible and provides the user feedback at each step of operation. The normal display of the Model 340 shows sensor readings and control status. Other specialized displays are used for instrument settings, data entry, help and error messages.

The normal display is discussed in Paragraph 4.2.1. Setting displays is discussed in Paragraph 4.2.2. Data entry displays are discussed in Paragraph 4.2.3. Finally, error displays are discussed in Paragraph 4.2.4.

4.2.1 Normal Display

The normal display is what the instrument shows under normal operating conditions, when the user is not changing a setting, and there is not a hardware failure detected. The top line of the display is dedicated to showing instrument status. Status annunciators appear on the top line when applicable. Annunciators that may be seen include: **Tune**, **Logging**, **Program**, **Ramping**, **Alarm**, **Remote**, and **Locked**.

The next four lines are used to show sensor input readings. This area is configurable by the user to show between one and eight readings. From one to four readings can be shown in large characters, five to eight readings are shown using smaller characters.

The bottom three lines show control settings and status. This area is configurable to show information from one or two control loops. If one loop is being displayed, the heater output can be shown in large characters. Some examples of normal display configurations are shown here. Instructions on how to change the display configuration are provided in the following paragraphs.

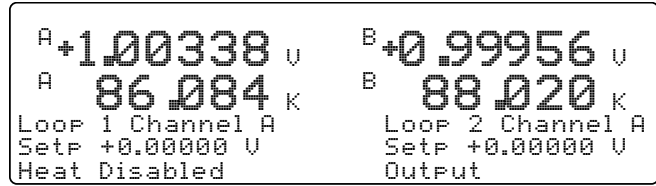

Normal Display with Both Loops Shown

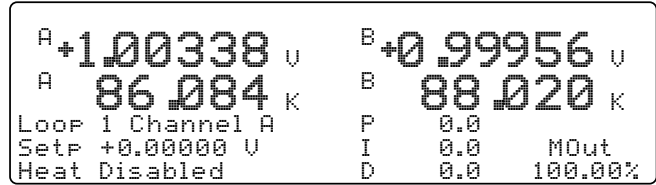

Normal Display with One Loop Shown

4.2.2 Setting Displays

Users may enter common parameters like control setpoint directly from the normal display. Other instrument setup parameters have unique setting displays that conveniently combine several related parameters on one screen. For details, refer to Paragraph 4.4 – Keypad Navigation.

4.2.3 Data Entry Displays

Data entry displays are special setting displays. Their layout allows easy entry of data tables including temperature response curves. They follow the same instructions as setting displays in Paragraph 4.4 – Keypad Navigation.

4.2.4 Error Displays

Some error conditions are part of normal operation and do not prevent the instrument from operating. Error messages for these will be shown on the normal display and the instrument will continue to operate until the situation is corrected. Errors that prevent the instrument from functioning properly can result in an error display that replaces the normal display. In this case the instrument will not try to operate until the error has been corrected. Error messages are summarized in Paragraph 11.9.

Some errors result from mistakes made when changing instrument settings or entering data. If this happens, read and follow the instructions shown. Also verify the settings by going back to the setting screen after the instrument has shown a normal display.

4.3 KEYPAD DESCRIPTION

The Model 340 has 40 keys on its keypad which help prompt the operator in using the large number of powerful software features. This section will help the user understand the keypad layout and how to quickly get to the features of interest.

The Model 340 keypad is divided into three groups. The group of 16 keys near the display is used for temperature control features. The middle group of 16 keys has two functions. The key surfaces are labeled with numbers and symbols for number entry. Above these keys are labels for temperature measurement, display and interface features. The last group of 8 keys is used for navigating in setting screens and has a few spare keys for features that the operator may need quickly.

Keypad Description (Continued)

Aside from the key location, the color of the panel behind the key is also important. Direct settings, made with the normal display showing, are initiated using keys with a gray background. The number keys and the gray backed **Enter**, **Escape**, up (▲), or down (▼) keys are used to complete these operations when needed.

The keys with a white background initiate a setting screen. One or more associated parameters are grouped on the setting screen. The white backed **Next Setting**, **Previous Setting**, **Save Screen**, **Cancel Screen**, and **More** keys are used to move around within setting screens. Once the desired parameter is highlighted, it can be set with the number entry keys. Examples are given below in keypad navigation.

4.4 KEYPAD NAVIGATION

This section gives specifics on how to set desired parameters. Number entry and setting selection are discussed first because these operations are needed for both direct settings and setting screens.

4.4.1 Changing Parameters

After highlighting the desired parameter, use the middle group of keys to enter a new value into the highlighted field. Press **Enter** to end data entry and accept the new value. Press **Escape** to end data entry and restore the old value. Press **Help** to view limits and resolution for most parameters.

NOTE: Within setting screens, press **Save Screen** to accept the entire screen. Press **Cancel Screen** or let the keypad time-out to return the screen parameters to pre-setting values.

Use the ▲ or ▼ key to toggle an On/Off or Yes/No toggle or select from a list of possible parameter settings. **Enter** accepts the new setting and **Escape** restores the old setting.

4.4.2 Direct Settings

To save the operator time, the most commonly used parameters can be set directly from the normal display screen. These keys are located in the area of the front panel with a gray background.

Some direct functions happen immediately when the key is pressed. These include the **Heater Off**, **Loop 1**, **Loop 2**, **Alarm Reset**, **Math Reset**, and **Local** keys. No other keys are required to complete these operations.

Pressing other keys with a gray background will highlight the parameter indicated on the key. The parameter can then be set by entering a number or selecting a setting. P, I, D, Manual Output and Setpoint values are entered as numbers. Heater Range and Control Channel are set with ▲ or ▼ key from a list of settings. Then press the **Enter** key to accept or **Escape** key to cancel.

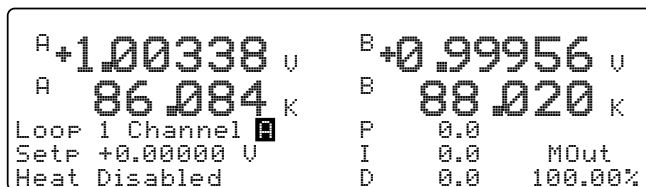

Normal Display with Control Channel Highlighted

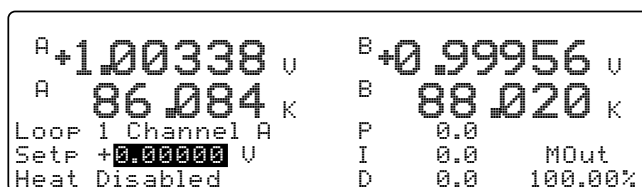

Normal Display with Temperature Setpoint Highlighted

4.4.3 Using Setting Screens

Use setting screens to change less used parameters. Press keys with a white background to display the parameter setting screen associated with that key. The setting screen title displays on the center of the top line.

On screens that contain parameters associated with sensor inputs or control loops, the top left corner will show the sensor input or control loop. This field must be set correctly before proceeding. Use the ▲ or ▼ key to select the appropriate sensor input or control loop and then press enter. The correct parameters will then be shown on the setting screen.

The **Next Setting** and **Previous Setting** keys are used to move around within the setting screen. Once a parameter has been chosen and it is highlighted, the data entry discussed above should be used to make changes. The **Next Setting** and **Previous Setting** keys will act like the **Enter** key and end the setting operation.

After making changes to a screen, press **Save Screen** to store the changes into the Model 340. Press **Cancel Screen** or let the keypad time-out to return screen parameters to pre-setting values.

A **<more>** annunciator may appear in the right corner of the screen to indicate that the parameters would not fit on one screen. Other parameters will be shown if the **More** key is pressed. If the **More** key is pressed after changes are made to a screen, a message prompts users to save or ignore the settings.

```

Input: A      INPUT SETUP
                Type: Silicon Diode
                Sensor Unit: U
                Temp Coeff: Neg.
Curve: 1 DT-470  Excitation: 10uA
SN: Standard   Range: ±2.5V
  
```

Entering a New Sensor Type for Input A

```

                READING DISPLAY FORMAT <more>
Input Displays: 4
Disp1: A  SENSOR  Disp2: A  SENSOR
Disp3: A  TEMP K  Disp4: A  TEMP K
  
```

Example screen showing <more>

4.4.4 Data Entry Screens

Data entry screens are similar to setting screens, but they have data tables that are too long to fit on a screen. Scroll up and down the data table instead of using the **More** key to change screens. In the following example of entering a temperature response curve, curve identification information is entered like a setting screen then the curve data is entered in a long table.

```

                Edit Curve: # 1
Name: DT-470      Sensor Temp(K)
SN: Standard     1: 0.09062 475.000
Limit: 499.900   2: 0.10191 470.000
Format: U/K      3: 0.11356 465.000
Coeff: Neg.      4: 0.12547 460.000
                5: 0.13759 455.000
                (I) Insert  (D) Delete
  
```

Entering a Temperature Response Curve

4.4.5 The Help Key

The **Help** key at the lower right corner of the keypad can be pressed while selecting a parameter. The information shown on the display will tell the operator the intended use of the parameter, then if the **More** key is pressed, the setting limits and resolution of the parameter. Next the help will show how to use the navigation keys discussed above as a reminder. Pressing **Cancel Screen** or the **Help** key will return the instrument to its setting operation. Pressing Help from the normal display shows how to use the navigation keys.

4.4.6 Keypad Time-out

The Model 340 suspends some of its operation during keypad operation. (The control loop and computer interfaces are never disabled.) A time-out was put in the keypad so that the instrument would return to normal operation if a key happened to be unintentionally pressed. The time-out acts like an **Escape** or **Cancel Screen** key being pressed so that no accidental changes are made to settings. Even with the time-out, we do not recommend you do long data entry operations while the instrument controls an experiment.

4.4.7 Key Definitions

Key	Description
AutoTune	Displays the AUTO TUNE screen to set Auto P, Auto PI, or Auto PID control mode.
Zone Settings	Displays the ZONE SETTINGS screen which specifies P, I, D, Manual Output, and Heater Range for up to 10 Temperature control zones.
Ramp	Displays the RAMP SETUP screen which turns ramp on or off and selects ramp rate.
Program	Displays the PROGRAM MODE screen. Allows the user to Run an internal program, Terminate a program, Edit a program, or Clear program memory.
P	Allows direct setting of the proportional (P) control parameter.
I	Allows direct setting of the integral (I) control parameter.
D	Allows direct setting of the derivative (D) control parameter.
Control Setup	Displays the CONTROL SETUP screen which enables the control loop, establishes power up status and setpoint units, sets heater resistance and control mode, and turns the filter on or off. Press the More key to display the CONTROL LIMITS screen which sets the temperature, slope, maximum heater current, and range.
Heater Range	Allows direct setting of Loop 1 heater range.
Heater Off	Immediately turns off Loop 1 heater.
Control Channel	Allows direct setting of the sensor feedback channel for a control loop.
Loop 1	Displays Control Loop 1 parameters and status on lower three lines of display.
Loop 2	Displays Control Loop 2 parameters and status on lower three lines of display.
Setpoint	Allows direct setting of control setpoint.
Manual Output	Allows direct setting of manual output control parameter.
Input Setup	Displays the INPUT SETUP screen which selects the sensor type and curve number. Other sensor parameters can be overwritten, but this changes sensor status to "Special." Only curves appropriate to the sensor type display.
SoftCal	Displays the SOFTCAL screen which accepts and stores SoftCal curves.
Display Format	Displays three screens (use the More key to toggle between the screens): 1. The READING DISPLAY FORMAT screen sets the number of readings (1 through 8) shown in the normal display and assigns an input and data source to each. 2. The CONTROL DISPLAY FORMAT screen sets lower three lines of the display. 3. The MISC. DISPLAY FORMAT screen sets display contrast, back lighting, and keypad lock.
Scan Setup	Displays the EXTERNAL SCANNER SETUP screen to set external scanner support.
Curve Entry	Displays the CURVE ENTRY screen which edits, copies, or erases temperature response curves.
Interface	Displays the COMPUTER INTERFACE screen which sets IEEE-488.2 and Serial interface parameters.
Alarm Setup	Displays the ALARM SETTINGS screen which enables or disables alarms and sets various alarm parameters.
Math Setup	Displays the MATH COMPUTATIONS screen which sets Max/Min and Filter parameters. Press the More key to see the LINEAR EQUATION screen.
Analog Outputs	Displays the ANALOG OUTPUTS screen which specifies Mode, Bipolar, Status, and other parameters for Analog Output A and B.
Alarm Reset	Immediately resets all latched alarms.
Math Reset	Immediately resets all Max and Min values.
Options	Displays four screens: 1. The DIGITAL I/O screen manually sets the digital inputs and outputs. 2. The RELAY & BEEPER SETUP screen allows the user to choose alarm or manual control for relays and to turn the beeper on or off. 3. The DATE & TIME screen is used to set real-time clock. 4. The REVISION INFORMATION screen displays the controller serial number and revision history. Use the More key to toggle between the screens.

Key Definitions (Continued)

Key	Description
Escape	Return a parameter to its original value during parameter entry.
Up (▲)	Toggle a parameter or selects a setting from a list.
Down (▼)	Toggle a parameter or selects a setting from a list.
Enter	Completes the operation of setting a value during parameter entry.
Cancel Screen	Returns parameters in a setting screen to pre-setting values.
Previous Screen	Moves to the previous parameter location within a setting screen.
Next Setting	Moves to the next parameter location within a setting screen..
Save Screen	Saves new parameter values in a setting screen.
More	Shows additional parameters that do not fit on one setting screen.
Local	Toggles the IEEE-488.2 Interface between remote and local modes.
Data Card	Displays the DATACARD screen. Allows the user to select Data Logging, Read DataCard, Write DataCard, and Erase DataCard. Datacards are useful for transferring temperature response curves, storing and restoring instrument parameters and internal programs, and updating main processor software.
Help	Displays a help screen for the highlighted parameter.

4.5 CHANGING DISPLAY FORMAT

The Model 340 lets the user decide which information is shown on the display. This section discusses the display fields that can be configured using the **Display Format** key.

4.5.1 Number of Readings Displayed

The Model 340 can display between one and eight input readings at a time. If one to four readings are chosen, they will be shown with the large characters. If five to eight readings are chosen, they will be shown with small characters.

To change the number of display readings, press the **Display Format** key. You will see the **Reading Display Format** screen with the current number of **Input Displays** highlighted. Use a number key or the **▲** or **▼** key to select the desired number of reading displays, then press the **Enter** key. The lower portion of the setting display will now show the available display fields ready for the operator to enter a sensor input and reading source. The default setting is 2.

4.5.2 Sensor Input

The Model 340 has two sensor inputs, A and B. More sensor input can be added with Model 340 options. Input A can be used to monitor more than one sensor with the use of an external scanner. Scanner support is covered in Paragraph 5.4.

To select a sensor input for a display field, press the **Display Format** key. You will see the **Display Format** screen with the current number of **Input Displays** highlighted. Use the **Enter** or **Next Setting** key to select the display number, then use the **▲** or **▼** key to select the desired input. Then press the **Enter** key. A sensor input can appear in as many reading fields as desired. The default setting is A and B.

4.5.3 Reading Source and Display Units

Readings shown on the display are taken from the sensor inputs, but a variety of digital processing can be done to the raw sensor data before it is displayed (see Figure 5-10). One or more of these sources can be displayed at the same time for an active sensor input.

Sensor	Raw sensor units as read from the temperature sensor.
Temp K	Temperature in Kelvin. Requires a temperature response curve selected in Input Setup. Refer to Paragraph 5.1.
Temp C	Temperature in Celsius. Requires a temperature response curve selected in Input Setup. Refer to Paragraph 5.1.
Max	Maximum value read since last reset. Refer to Paragraph 5.3.2.
Min	Minimum value read since last reset. Refer to Paragraph 5.3.2.
Linear	Output of a linear equation. Refer to Paragraph 5.3.3.

To select a display reading source, enter the sensor input (above). Press the **Enter** key to highlight the field next to the input. Use the **▲** or **▼** key to select a source for that reading display from the list. If a temperature source is selected and no temperature response curve is present an error message will appear on the normal display (**NOCURV**). Press the **Enter** or **Next Setting** key to change the next reading display. Press the **Save Screen** key to store the changes in the Model 340. The default setting is Temp K.

4.5.4 Control Loop Display

The Model 340 has the ability to operate one or two temperature control loops. The user has the option of displaying parameters from either one or both loops. When both loops are displayed, fewer parameters are shown on the normal display. The hidden parameters can be viewed by pressing the **Loop 1** or **Loop 2** key, they will also appear when being changed.

Loop 1	Displays Loop 1 parameters including P, I, D and Manual Out
Loop 2	Displays Loop 2 parameters including P, I, D and Manual Out
Both	Displays setpoint, control channel, and percent (%) output for both loops, Heater Range for Loop 1.
None	Neither set of control loop parameters are shown.

To select a control loop display format, press the **Display Format** key, then press the **More** key to show the **CONTROL DISPLAY FORMAT** screen. The control loops line will be highlighted so use the **▲** or **▼** key to select one of the choices. Press the **Enter** or **Next Setting** key to continue with other settings. Press the **Save Screen** key to store the changes in the Model 340. The default setting is Loop 1.

4.5.5 Large Heater Display

There are applications where the amount of power being driven into the control load is as important as the control temperature. In this case the control loop output can be shown in large characters on the display. The larger output will replace P, I, D, and Manual Output on the display. The hidden parameters will still appear when being changed.

To turn the large output display on or off, press the **Display Format** key, then press the **More** key until you see the **CONTROL DISPLAY FORMAT** screen. Press the **Next Setting** key until the **Large Output** line is highlighted, then use the **▲** or **▼** key to select on or off. Press the **Enter** or **Next Setting** key to continue with other settings. Press the **Save Screen** key to store the changes in the Model 340. The default setting is Off.

NOTE: The **Large Output** option will not be visible if **Control Loops: BOTH** is selected. Change the Control Loop setting back to **Loop 1** or **Loop 2**, press the **Enter** key, then the **Large Output** selection will be available.

4.5.6 Heater Output Display Units

The **CONTROL DISPLAY FORMAT** screen is also the place to select whether heater output is shown as **POWER** or **CURRENT**. This setting will impact the heater output seen in the normal display and which units are used for the manual output (**MOut**) display. If current is selected, the heater output and range will appear as **20% @ 100 W** to indicate 20% output current for the selected 100 watt range. If power is selected for the same output, the heater output and range would appear as **4% of 100W** to indicate 4% output power for the selected 100 watt range.

To change the heater display units, press the **Display Format** key, then press the **More** key until you see the **CONTROL DISPLAY FORMAT** screen. Press the **Next Setting** key until the **Heat Display** line is highlighted, then use the **▲** or **▼** key to select **Current** or **Power**. Press the **Enter** or **Next Setting** key to continue with other settings. Press the **Save Screen** key to store the changes. The default setting is Current.

4.5.7 Display Contrast

The Model 340 has a high contrast, LCD display with a bright backlight. The factory contrast setting is good for most applications, but it will need to be changed for arrangements of equipment that put the Model 340 well above or below eye level. Display contrast can be set to a value between 0 and 100. Please note that changing contrast has no effect on the display backlight.

To change display contrast, press the **Display Format** key then press the **More** key until the **Misc. Display Format** screen is displayed. Press the **Next Setting** key until the **Contrast** line is highlighted, then use the **▲** or **▼** key to adjust contrast. The contrast will change as the parameter is being set, so adjustments should be made with the operator and instrument in their normal positions. Press the **Enter** or **Next Setting** key to continue with other settings. Press the **Save Screen** key to store the changes in the Model 340. The default setting is 50.

4.5.8 Display Backlight On/Off

The Model 340 display used a florescent tube as a backlight. The backlight is powered with a high voltage supply operating at 30 kHz. Some experiments are sensitive to noise in the frequency range of 30 kHz, so the backlight power supply can be turned off. Please note that the display is unreadable when the backlight is off.

To turn the display backlight off, press the **Display Format** key, then press the **More** key to show the **MISC. DISPLAY FORMAT** screen. Press the **Next Setting** key until the line for backlight is highlighted, then use the **▲** or **▼** key to turn the backlight off. Press the **Save Screen** key to store the changes. Default setting is On.

To turn the display backlight back on, press any key on the keypad.

4.5.9 Locking the Keypad

The Model 340 has a keypad lock feature to prevent accidental changes to instrument parameters and minimize the disturbances of curious onlookers. A simple 3 number sequence is the code needed to lock and unlock the keypad. The factory default code is **123** and it can only be changed using a computer interface.

To lock or unlock the keypad, press the **Display Format** key then press the **More** key to show the **Misc. Display Format** screen. Press the **Next Setting** key until **Lock** is highlighted, then use the **▲** or **▼** key to toggle the lock setting. Press the **Enter** key. A small setting window will appear for entering a three digit number code. Use the number keys to enter the code, then press the **Enter** key. Press the **Save Screen** key to store the lock status in the Model 340. The default setting is unlocked, code **123**.

When the keypad is locked, you can still see values for the various parameters, you just cannot change them. The only front panel keys that are active when the keypad is locked are the Heater Off and Alarm Reset keys.

4.6 DEFAULT VALUES

It is sometimes necessary to reset instrument parameters to their factory default values. These values can be cleared without affecting instrument calibration.

To reset the Model 340 parameters to factory default values, press the **Options** key then press the **More** key until the Revision Information screen is displayed. Use the **▲** or **▼** key to change the Set Defaults setting to Yes, then press the **Enter** key. Press the **Save Screen** key to complete the action. The Model 340 will then restart using the factory default values.

CHAPTER 5

SENSOR INPUT AND TEMPERATURE MEASUREMENT OPERATION

5.0 GENERAL

This chapter describes front panel operation for sensor input configuration and temperature measurement. The user must setup temperature sensor input before a valid sensor reading can be made, and select a temperature response curve to convert readings to temperature. This chapter covers sensor input setup in Paragraph 5.1, selecting a temperature response curve in Paragraph 5.2, filter and math functions in Paragraph 5.3, and scanner support in Paragraph 5.4.

5.1 SENSOR INPUT SETUP

This section covers sensor type in Paragraph 5.1.1, voltage excitation in Paragraph 5.1.2, thermal EMF compensation with voltage excitation in Paragraph 5.1.3, special sensor type configuration in Paragraph 5.1.4, and turning an input off in Paragraph 5.1.5.

5.1.1 Sensor Type

The first step in sensor input configuration is setting the sensor type parameter. The Model 340 works with a variety of different sensors, each with special requirements for excitation and input range. Selections for several different types of sensors are pre-programmed into the Model 340. If using one of these sensor types, select that type to automatically change the associated parameters listed in Table 5-1.

Table 5-1. Sensor Types Recognized by the Model 340

Type	Units	Excitation	Range	Temp. Coefficient	Update
Silicon Diode	volts	10 μ A	0-2.5 V	Negative	20 Hz
GaAlAs Diode	volts	10 μ A	0-7.5 V	Negative	20 Hz
Platinum 100/250	ohms	1 mA	0-250 Ω	Positive	20 Hz
Platinum 100/500	ohms	1 mA	0-500 Ω	Positive	20 Hz
Platinum 1000	ohms	100 μ A	0-2500 Ω	Positive	20 Hz
Rhodium-Iron	ohms	1 mA	0-250 Ω	Positive	20 Hz
*Carbon-Glass	ohms	10 mV	0-300 k Ω	Negative	10 Hz
*Cernox	ohms	10 mV	0-300 k Ω	Negative	10 Hz
*Ruthenium Oxide	ohms	10 mV	0-300 k Ω	Negative	10 Hz
*Germanium	ohms	1 mV	0-30 k Ω	Negative	10 Hz

* Refer to Paragraph 5.1.2 for voltage excitation for these sensors. Approximate temperature ranges are given with specifications. Other sensor types are available with input option cards.

To select a pre-programmed sensor type, press **Input Setup**. The input setup setting screen appears with the input letter in the top left hand corner. Use the **▲** or **▼** key to select an input. Press **Enter** or **Next Setting** to display the input parameters. Press **Next Setting** until the type field highlights and then use the **▲** or **▼** key to select one of the sensor types in the table above. Press **Enter** or **Next Setting** to show the input parameters for that sensor type. To proceed to temperature response curve selection (Paragraph 5.2), press **Previous Setting** or press **Save Screen** to store the changes in the Model 340. The default setting is Silicon Diode.

NOTE: If the user changes any of the parameters listed for a standard sensor type, the instrument assumes a special sensor type is required (Paragraph 5.1.4).

NOTE: Use the display setup screen (Paragraph 4.5) to show configured readings from an input on the display.

5.1.2 Voltage Excitation (Current Autorange)

Several RTD sensor types have a nonlinear temperature response. These sensors require special excitation so that their signal can be read with good resolution and at the same time not too much power is dissipated in the sensor. When these sensors are being read by the Model 340, the current excitation is automatically ranged to keep the voltage across the sensor below that listed in the table above. To illustrate the effect, power can be expressed by either:

$$P = I^2 \times R \text{ or } P = \frac{V^2}{R}.$$

Using these negative temperature coefficient resistors with resistance (R) and a constant current (I) excitation, the power in the sensor will increase as temperature drops (resistance increases), but with constant voltage (V) excitation, the power reduces as temperature drops.

Voltage excitation is indicated for several sensors in the table above that should be read using low power. Other than using an autoranging current source, voltage excitation often requires compensation for thermal EMF that is described below. Note that thermal compensation will reduce the update rate of these inputs from 20 readings per second to 10 readings per second.

5.1.3 Thermal EMF Compensation with Voltage Excitation

Sensors that require voltage excitation must be operated with little power dissipated in the sensor. To keep power low, the voltage across the sensor is kept low. There are two major problems that occur when measuring small DC voltages. The first is external noise entering the measurement through the sensor leads which is discussed with sensor setup. The second problem is the presence of thermal EMF voltages, sometimes called thermocouple voltages, in the lead wiring. Thermal EMF voltages appear whenever there is a temperature gradient across a piece of voltage lead. They can be canceled in the measurement with a similar temperature gradient in the other voltage lead. Thermal EMF voltages must exist because the sensor is almost never the same temperature as the instrument. They can be minimized by careful wiring, making sure the voltage leads are symmetrical in the type of metal used and how they are joined, and by keeping unnecessary heat sources away from the leads. Even in a well designed system thermal EMF voltages can be an appreciable part of a low voltage sensor measurement.

The Model 340 can help with a thermal correction algorithm. The instrument will automatically reverse the polarity of the current source every other reading. The average of the positive and negative sensor readings will cancel the thermal EMF voltage which is present in the same polarity, regardless of current direction. The settling time associated with current reversal will reduce the update rate of a corrected input from 20 readings per second to 10 readings per second.

Thermal correction can be turned off, but it is not recommended because reading errors will increase. The default setting is **ON**. Thermal correction can also be paused for a short time. This feature is useful when the temperature system is stable and the user wants to make delicate experimental measurements with little disturbance entering the system. The **Reverse** setting is for diagnostic purposes only. Thermal correction parameter field will appear on the input setup screen when a sensor type using voltage excitation is selected.

To change the thermal correction parameter to on, off or pause, press the **Input Setup** key. The input setup setting screen will appear with the Input letter in the top left hand corner. Use the **▲** or **▼** key to select an input. Press the **Enter** key or the **Next Setting** key to display the input parameters for that input. Press the **Next Setting** key until the thermal compensation field is highlighted and then use the **▲** or **▼** key to select on, off or pause. Press the **Next Setting** key to continue with more settings or press the **Save Screen** key to store the changes in the Model 340. The default setting is On.

5.1.4 Special Sensor Type Configuration

The Model 340 allows sensors that do not match a pre-programmed type. Configure input excitation and input range selections to meet specific needs. Users may set the temperature coefficient to allow a specially configured input as a control channel, display units in volts or ohms, and create and select a response curve for the special input or use a linear equation to compensate for the raw reading.

The Model 340 pre-programmed settings do not include every combination of excitation and input range. Setting combinations not included in pre-programmed conditions do not have published specifications. The user must determine input configuration suitability for their application.

Table 5-2. Special Sensor Type Configuration

Excitation	Input Range	Temperature Coefficient	Units
1 mA	5 V	Positive	Volts
300 μ A	2.5 V	Negative	Ohms
100 μ A	1 V		
30 μ A	500 mV		
10 μ A	250 mV		
3 μ A	100 mV		
1 μ A	50 mV		
300 nA	25 mV		
100 nA	10 mV		
30 nA	5 mV		
*10 mV	2.5 mV		
*1 mV	1 mV		

The columns in the above table can be selected independently. When voltage units are selected the input range is as listed in the table. When resistance units are selected, resistance range can be computed as $R = V/I$. Again, it is up to the user to determine the suitability of a special input configuration. Input configurations that indicate a resistance range of more than 1 M Ω are not recommended because the instrument itself will begin to cause measurement errors.

To select a special sensor type, press the **Input Setup** key. The input setup setting screen will appear with the input letter in the top left hand corner. Use the \blacktriangle or \blacktriangledown key to select an input. Press the **Enter** key or the **Next Setting** key to display the input parameters for that input. Press the **Next Setting** key until the type field is highlighted and then use \blacktriangle or \blacktriangledown key to select special from the list of settings. Press the **Enter** key or the **Next Setting** key and to advance to the next parameter. Set the parameters of units, temperature coefficient, excitation and input range from the list in the table above. If special setup was successful, proceed to temperature response curve selection in Paragraph 5.2 by pressing the **Previous Setting** key or press the **Save Screen** key to store the changes in the Model 340.

5.1.5 Turning an Input Off

There are cases, particularly when using scanned inputs, that the user may wish to turn off an input. This can be done from the input setup screen. If an input that has been turned off is chosen for the display, the **DISABLE** message will appear in the reading field.

To turn an input off, press the **Input Setup** key. The **INPUT SETUP** screen will appear with the input letter in the top left hand corner. Use the \blacktriangle or \blacktriangledown key to select input **A** or **B**. Press the **Enter** or **Next Setting** key until the **Enable** field is highlighted. Use the \blacktriangle or \blacktriangledown key to select **OFF**. Press the **Save Screen** key to store the change in the Model 340.

5.2 SELECTING A TEMPERATURE RESPONSE CURVE

A temperature response curve is needed to convert a sensor reading in sensor units to temperature. A curve is a table of breakpoints, each containing a temperature value and its sensor units equivalent for the sensor. The section on sensor selection discusses different ways of obtaining temperature response curves. Curves can also be created by the user and entered into the instrument as described in the curve entry section. It is assumed that an appropriate curve is present in the Model 340 before proceeding with this section.

Some types of sensors behave in a predictable manner and a standard temperature response curve can be created for them. The Model 340 has standard curves included in firmware. Refer to Table 5-3. Details on standard curves are provided in Appendix B.

Curves entered by the user or loaded as CalCurves will appear during curve selection list. They will have curve number 21 to 60. The sensor serial number will appear on the setting screen and can be used to identify a unique curve if the serial number was included with the curve table.

NOTE: During curve selection, the instrument may only show the curves that are appropriate for an input type. It is necessary to select an appropriate input type before selecting a curve. Refer to Paragraph 5.4 for a description of how to select multiple curves for a scanned input.

To select a temperature response curve, press the **Input Setup** key. The input setup setting screen will appear with the input letter in the top left hand corner. Use the **▲** or **▼** key to select an input. Press the **Enter** key or the **Next Setting** key to display the input parameters for that input. Press the **Next Setting** key until the curve field is highlighted and then use **▲** or **▼** key to select a curve from the list. Press the **Enter** key or the **Next Setting** key and to advance to the next parameter. (If curve selection was not successful, press the **Next Setting** key and verify the appropriate type selection). Press the **Save Screen** key to store the changes in the Model 340.

Table 5-3. Standard Curve Table

Curve Setting	No.	Sensor Type	Model Number	Curve Name	Temp. Range	Table
DT-470	1	Silicon Diode	DT-470	Curve 10	1.4 – 475 K	A-1
DT-500-D	2	Silicon Diode	*DT-500-DRC-D	Curve D	1.4 – 365 K	A-2
DT-500-E1	3	Silicon Diode	*DT-500/DRC-E1	Curve E1	1.4 – 330 K	
PT-100	4	Platinum RTD 100	PT-100	DIN 43760	30 – 800 K	A-3
PT-1000	5	Platinum RTD 1000	*PT-1000	DIN 43760	30 – 800 K	
Type K	6	Thermocouple	Type K	Type K	3.15 – 864 K (1500 K [†])	A-4
Type E	7	Thermocouple	Type E	Type E	3.15 – 622 K (930 K [†])	A-5
Type T	8	Thermocouple	Type T	Type T	3.15 – 670 K	A-6
AuFe .03%	9	Thermocouple	Chromel-AuFe 0.03%	Chromel-AuFe 0.03%	3.50 – 500 K	A-7
AuFe .07%	10	Thermocouple	Chromel-AuFe 0.07%	Chromel-AuFe 0.07%	3.15 – 610 K	A-8
DT-670	11	Silicon Diode	DT-670	DT-670	1.4 – 500 K	A-9

* Curves supported but sensors no longer available through Lake Shore.

† Temperature range extended when using ±50 mV Range.

5.3 FILTER AND MATH

Some simple arithmetic features have been included in the Model 340 as a convenience to the user. Filter, Max, Min and linear equation can be applied to an input reading. As shown in Figure 5-1, the filter can be applied to all readings for an input. The results of Max, Min, and linear equation can be shown on the display in combination with the actual input reading. The display format screen is used to configure the display.

5.3.1 Filter

The Model 340 can apply an averaging filter to any sensor input. The filter is designed to prevent electronic noise that is picked up on the sensor lead wires from showing on the display. It is enabled or disabled for all of the reading formats of an input at the same time. A number of readings filtered and filter reset window can be changed by the user to meet their application. The control equation has a filter that is enabled independently from the input filter.

To turn on the filter for an input, press the **Math Setup** key. The **MATH COMPUTATIONS** screen appears with the **Input** field highlighted. Use the **▲** or **▼** key to select an input. Use the **Enter** or **Next Setting** key to move the cursor to **FILTER Enable**. Use the **▲** or **▼** key to select **ON**. The default setting is On.

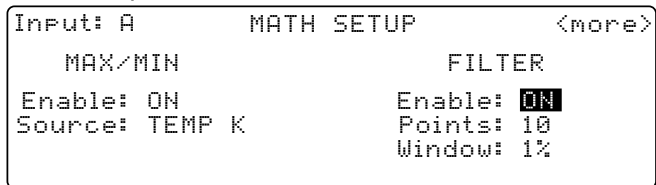

The user may change filter behavior by changing the number filter readings. Although more filter readings settle the display reading more, it is not always appropriate to select many filter readings. More filter readings also slow display reading response to real temperature changes in the load.

To change on the filter readings (points) for an input, press the **Math Setup** key. You see the **MATH COMPUTATIONS** screen. The **Input** field is highlighted. Use the **▲** or **▼** key to select an Input. Use the **Enter** or **Next Setting** key to move the cursor to **FILTER Points**. Use the **▲** or **▼** key to select the desired number. The minimum number of points is 2, the maximum is 64. The default setting is 10.

Some users do not want the filter to slow the response of the display reading when large deliberate changes in temperature are made. The filter window parameter allows the user to set the limit for a large temperature change. If an unfiltered reading differs from the filtered reading by more than the filter window limit, the filter will be restarted. The filter window limit is set in percent of full scale range for the selected input type.

To change the filter window for an input, press the **Math Setup** key. You will see the **MATH COMPUTATIONS** screen. The **Input** field will be highlighted. Use the **▲** or **▼** key to select an Input. Use the **Enter** or **Next Setting** key to move the cursor to **FILTER Window**. Use the **▲** or **▼** key to select the desired percentage. The minimum is 1%, the maximum is 10%. The default setting is 1%.

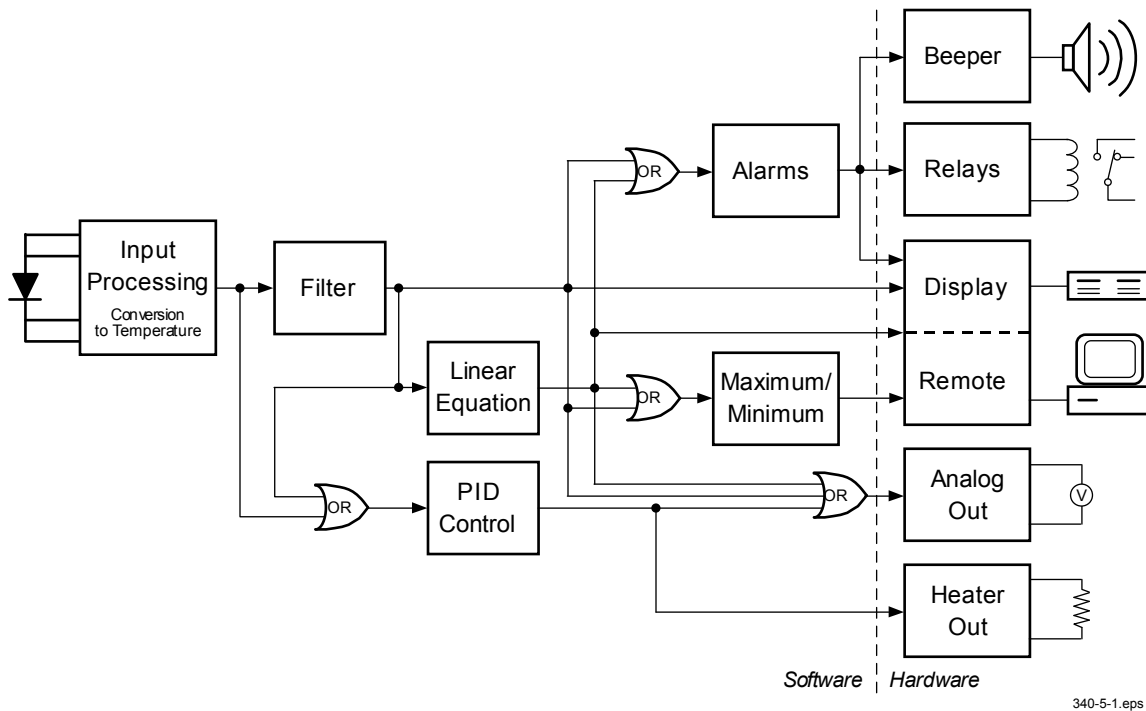

Figure 5-1. Data Flow

5.3.2 Max/Min

The Model 340 will save the highest (Max) and lowest (Min) reading of a sensor input when the Max/Min feature is turned on. The feature can be paused to save these stored values after the observation period is over. A source for Max/Min must be selected on the math setup screen. There are four possible sources for the Max/Min feature. The input reading in sensor units, kelvin, Celsius, or the result of the linear equation can be chosen. Max/Min will work with one source for an input but different inputs can have different sources. Max and Min will not automatically show on the display. Use the Reading Display Format screen described in Paragraph 4.5 to show Max and Min on the display.

To use the Max/Min feature, press the **Math Setup** key. The math setting screen will appear with the input letter in the top left hand corner. Use the **▲** or **▼** key to select an input. Press the **Enter** key or the **Next Setting** key to display the Max/Min parameters for that input. Press the **Next Setting** key until the Max/Min enable field is highlighted and then use **▲** or **▼** key to select on. Press the **Next Setting** key or the **Enter** key to advance to the source field. Use the **▲** or **▼** key to select one of the four sources. Press the **Next Setting** key to make other changes. Press the **Save Screen** key to store the change in the Model 340. The default settings are On, kelvin.

When the Max./Min feature is setup, it will not automatically appear on the display. Use the display format screen to add a reading field to the display and select the input and math source for that new field. Display format is discussed in Paragraph 4.5.

To Pause the Max/Min feature, press the **Math Setup** key. The math setting screen will appear with the input letter in the top left hand corner. Use the **▲** or **▼** key to select an input. Press the **Enter** key or the **Next Setting** key to display the Max/Min parameters for that input. Press the **Next Setting** key until the Max/Min enable field is highlighted and then use **▲** or **▼** key to select pause. Press the **Save Screen** key to store the change in the Model 340. Changing back and fourth between on and pause will not reset the values.

To reset the Max/Min values, press the **Math Reset** key from the normal display. Math reset is an immediate operation.

5.3.3 Linear Equation

The Model 340 can calculate a linear equation as a special data processing feature. The output of this calculation can be shown on the display or directed to an analog output for proportional control of other hardware in an experiment. One computation can be done for each sensor input. The output will not automatically show on the display, use the display format setting screen described in Paragraph 4.5 to change display settings. If an analog output is being used, its output scale must be set (Paragraph 7.1).

There are two different equations available. In each: M is a gain or slope, X is an input reading, and B is an offset or intercept (not to be confused with input B). The two equations are shown in the table below. The difference between them is subtle. The first equation is used to scale the raw reading of an input, similar to a temperature response curve, when the sensor has linear response. The second is better at generating a control signal when a setpoint (SP1 or SP2) is selected as B. The control signal can then be directed to an analog output. The second equation is also useful whenever a reading of deviation from setpoint is needed.

The columns settings in Table 5-4 are selected independently. "Number" represents a number entered by the user. "X" can be set to an input reading in sensor units or temperature in kelvin or Celsius. SP1 represents setpoint of Loop 1 and similarly for other B settings.

Table 5-4. Linear Equation Configuration

Equation	M	X	B
MX+B	Number	Sensor	Number
M(X+B)		Temp K	SP1
		Temp C	-SP1
			SP2
			-SP2

To setup a linear equation, press the **Math Setup** key and the math setting screen will appear. Press the **More** key to show the setting screen for linear equation with the input letter in the top left hand corner. Use the **▲** or **▼** key to select an input. Press the **Enter** key or the **Next Setting** key to display the equation parameters for that input. Use the **▲** or **▼** key to select one of the two equations from the highlighted equation field. Press the **Next Setting** key and continue to select parameter settings for M, X, and B. A number setting field will appear next to the field for B if number is selected from the B setting list. The scale factor can be selected as n, μ , m, k, M, or G. Blank indicates a scale factory of x1. Press the **Save Screen** key to store the change in the Model 340. The default settings are M(X+B), 1, K, -SP1.

5.4 SCANNER SUPPORT

The Model 340 supports a user-supplied sensor scanner (external to the instrument). Scan up to 16 sensors of the same type into input A. The sensors must be the same type because only one sensor type setting can be made for the A input. Each of the 16 sensors (channels) can have a unique temperature response curve. There are different modes of scan operation that allow for active scan channel selection. If a channel is not actively read, the last valid reading for that channel either displays or reports over the computer interface. Four-lead sensor measurement is always recommended when scanning temperature sensors.

5.4.1 Scan Modes

Scanner support has different modes for selecting which of the channels is actively being read. Each mode allows for a different scanner applications.

Manual	The user manually selects the scan channel over front panel or computer interface. Digital outputs report the scanned channel if set to scanner mode.
Auto Scan	The instrument sequences through enabled channels, holding on each channel for a user-specified interval. Digital outputs report the scanned channel if set to scanner mode.
Slave	The external scanner selects the channel through the digital inputs
Off	All scan functions are disabled.

To select a scanner support mode, press the **Scan Setup** key. The Mode field will be highlighted. Use the **▲** or **▼** key to select the appropriate scan mode. Then press the **Save Screen** key. The default setting is Off.

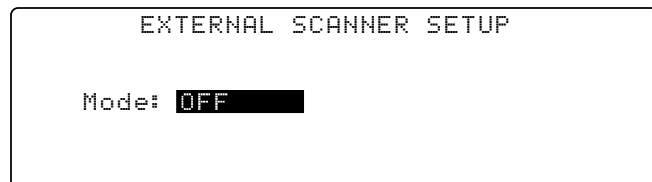

5.4.2 Input Setup with a Scan Mode Active

When any of the scan modes are selected, the input setup screen for the A input will change slightly. The input field will allow setting of channel A1 through A16 and a temperature response curve can be entered for each channel. Changing parameters other than enable and curve will act globally for all channels.

To select a scan channel for setup, press the **Input Setup** key. Use the ▲ or ▼ key to select input **A**. Press the **Enter** key. The scan channel number will be highlighted. Use the ▲ or ▼ key to select the desired scan channel number (1 through 16). Press the **Enter** key. The **Enable** field is now highlighted. Use the ▲ or ▼ key to select **ON**. Press the **Enter** key. The **Curve** field is now highlighted. Use the ▲ or ▼ key to select the desired sensor to temperature curve (only curves appropriate to the sensor type display). Press the **Save Screen** key. The default settings are Channel 1 and Enable On.

Once the channels are setup and enabled, use Display Format to actually display the results of the scan channels on the front panel. Refer to Paragraph 4.5.

5.4.3 Manual Scanning

Once the individual input channels have a designated curve, the user can manually select the channel to be scanned. The Model 340 can set its digital outputs to the corresponding scan channel. If the external scanner has digital control inputs the Model 340 can be used to select a channel. This is a convenient way to synchronize the scanned readings or automate the scan operation using only the interface of the Model 340.

To manually select a scan channel for reading, press the **Scan Setup** key. The **Mode** field will be highlighted. Use the ▲ or ▼ key to select **MANUAL**. Press the **Enter** key. The Channel selector will appear. Use the ▲ or ▼ key to select the appropriate channel and press the **Save Screen** key to store the change in the Model 340. The default setting is A1.

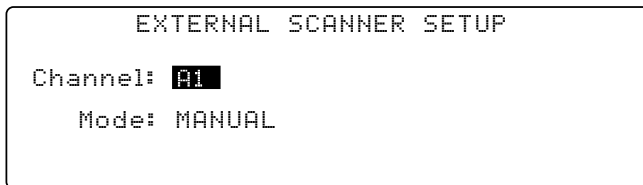

The digital outputs must be set to scan mode to report the scan channel. Refer to Paragraph 7.2 for digital output mode setting. When the digital outputs are set to work with the scanner and manual scan mode selected, digital output signals D1 to D4 report the active scan channel as shown below. Digital output logic levels are described in Paragraph 7.2.

Channel	DO4	DO3	DO2	DO1
1	0	0	0	0
2	0	0	0	1
3	0	0	1	0
4	0	0	1	1
5	0	1	0	0
6	0	1	0	1
7	0	1	1	0
8	0	1	1	1
9	1	0	0	0
10	1	0	0	1
11	1	0	1	0
12	1	1	1	1
13	1	1	0	0
14	1	1	0	1
15	1	1	1	0
16	1	1	1	1

5.4.4 Auto Scanning

Once the individual input channels are enabled and have a designated curve, the Auto Scan feature can sequence through the enabled channels. A scan interval can be set by the user to tell the instrument how long to read a channel before moving to the next. The interval is set in seconds and has a range of 2 to 200. The Model 340 can set its digital outputs to the corresponding Auto Scan channel. If the external scanner has digital control inputs the Model 340 can be used to select a channel. This is a convenient way to synchronize the scanned readings or automate the scan operation using only Model 340.

To change the reading interval for the Auto Scan mode, start with the scan mode set to Auto Scan. Press the **Scan Setup** key and the scan setup screen will appear. Press the **Next Setting** or **Previous Setting** key until the interval field is highlighted. Use the **▲** or **▼** key to select the appropriate scan interval in seconds. Press the

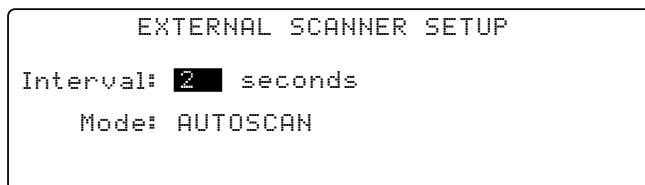

Save Screen key to store the setting in the Model 340. Please note that only input channels that have been enabled on the input setup screen will be read in sequence. The default setting is 2.

The digital outputs must be set to scan mode to report the scan channel, refer to Paragraph 7.2 for digital output mode setting. When the digital outputs are set to work with the scanner and Auto Scan mode selected, digital output signals D1 to D4 report the active scan channel as shown in the table above.

5.4.5 Slave Scanning

In some application it is necessary for the external scanner or other external hardware to select the active scan channel. In scanner slave mode the Model 340 will change to the active scan channel to the channel indicated on the digital inputs. The digital inputs do not need any special setup. The active scan channel will follow the digital inputs as shown in the table below. Digital input logic levels are described in Paragraph 7.2.

Channel	DI4	DI3	DI2	DI1
1	0	0	0	0
2	0	0	0	1
3	0	0	1	0
4	0	0	1	1
5	0	1	0	0
6	0	1	0	1
7	0	1	1	0
8	0	1	1	1
9	1	0	0	0
10	1	0	0	1
11	1	0	1	0
12	1	1	1	1
13	1	1	0	0
14	1	1	0	1
15	1	1	1	0
16	1	1	1	1

CHAPTER 6

TEMPERATURE CONTROL OPERATION

6.0 GENERAL

There are many steps involved in setting up and operating a control loop. The earlier chapters of this manual discuss hardware setup and the basic principals of tuning the control parameters to an individual system. This section describes operation of the instrument control features and how to set control parameters. There are several parameters that must be set before the Model 340 can perform even simple temperature control functions. Each of the parameters in this chapter should be considered before turning the heater on. The user should also verify that the sensor inputs are reporting correct temperature readings before proceeding.

The Model 340 has the ability to run two independent control loops, so it is called a two-loop controller. Loop 1 is the primary control loop, capable of sourcing more power and has additional software features. The heater output for Loop 1 is a traditional control output for a cryogenic temperature controller. Heater output is the most visible difference between the two control loops which are summarized in Table 1-1. Loop 2 is an auxiliary control loop with enough features to control a radiation shield or small sample heater. Setting up hardware for the two control loops is discussed in Chapter 2. This section describes how to display control loop parameters and output or make parameter changes.

Control loop display is described in Paragraph 6.1. Control loop enable is described in Paragraph 6.2. Control loop filter is described in Paragraph 6.3. The control channel is described in Paragraph 6.4. Control modes are described in Paragraph 6.5. Manual setting of PID control parameters are described in Paragraph 6.6. Selecting an AutoTune control mode is described in Paragraph 6.7. Zone control data entry is described in Paragraph 6.8. Using an open loop control is described in Paragraph 6.9. Setting a setpoint and setpoint units are described in Paragraph 6.10. Setpoint ramping is described in Paragraph 6.11. Control output is described in Paragraph 6.12. Finally, control output limits are described in Paragraph 6.13.

6.1 CONTROL LOOP DISPLAYS

This paragraph describes how the control parameters and control output are shown on the normal front panel display. Control loops on the normal display are described in Paragraph 6.1.1. Loop indication on the normal display is described in Paragraph 6.1.2. Loop indication on setting screens is described in Paragraph 6.1.3. Finally, control output display is described in Paragraph 6.1.4.

6.1.1 Control Loops on the Normal Display

Several control parameters are shown on the normal display so they can be changed quickly by the operator. The **CONTROL DISPLAY FORMAT** screen configures the control parameter portion of the display. The user can decide to show parameters from one or both loops depending on the experiment. When one loop is in operation, only that loop should be selected since more parameters are shown for that loop. When two loops are shown, the operator must tell the instrument which loop to use before a parameter can be changed. Use the **Display Format** key to get to the **CONTROL DISPLAY FORMAT** screen.

6.1.2 Loop Indication on the Normal Display

When operating both control loops, indicate which control loop changes by using the **Loop 1** and **Loop 2** keys. The key functions are not dependent on the display format, but the setting will default to the loop showing on the display when only one loop is present.

The **Loop 1** key displays Loop 1 information. The **Loop 2** key displays Loop 2 information. The lower three lines on either display show Loop parameters accessed from the normal display. Parameters unavailable for Loop 2 do not display. After a time-out period the display returns to normal.

6.1.3 Loop Indication on Setting Screens

The loop indicator appears in the top left hand corner of setting screens; change it like a parameter for that screen. Press **Enter** after selecting a loop to display parameters for that loop on the setting screen.

6.1.4 Control Output Display

The Model 340 shows the control output value on the display so the operator can monitor the control loop performance during an experiment or while tuning. The output value is shown on the display whenever loop parameters for that loop are shown. Control output can also be shown on the display using large characters. Refer to Paragraph 4.5 for display format.

If the message “Disabled” appears in the control output field of the display, the control loop must be enabled from the **CONTROL SETUP** screen before it is operational, refer to Paragraph 6.2. (There is an enable setting for each control loop and it is independent of heater range.)

Hardware included in the heater output circuit allows more features in monitoring and displaying control output for Loop 1. If the correct value of heater resistance is entered, the heater output can be shown on the display in power. To change heater output units, refer to Paragraph 4.5.6. The heater output is reported in percent of full scale current or power for a given heater range. Full scale for the range is shown on the display to indicate which range is selected. An A/D converter in the heater output circuitry also allows the Model 340 to diagnose problems in the heater circuit. If an error is detected, a message appears in the control output field of the display. These errors are summarized in Paragraph 11.9. Error messages are not possible for Loop 2. When Analog Output 2 is used for control output of Loop 2, the control output is reported in percent of full scale output voltage.

6.2 CONTROL LOOP ENABLE

As a safety feature, both Control Loop 1 and 2 default to the disabled state. This state ensures that the heater output for Loop 1 is off and Analog Output 2 for Loop 2 is set to zero volts. The user must enable a control output before it can be used. If an output is disabled, the message Disabled appears in the control output field of the display.

To enable or disable a control output, press the **Control Setup** key. The **CONTROL SETUP** screen is displayed. The control loop indicator is highlighted in the upper left hand corner. Use **▲** or **▼** key to select Loop 1 or 2. Press the **Enter** or **Next Setting** key. The control setup parameters for that loop appear on the screen. Press the **Next Setting** key until the **Enable** field is highlighted. Use the **▲** or **▼** key to select **ON** for enabled or **OFF** for disabled. Press the **Enter** or **Next Setting** key to continue with more settings, or press the **Save Screen** key to store the changes in the Model 340. The default setting is Off.

Some systems require that a control output remains off if power is lost. The power up enable feature enables the user to choose whether or not they want the control output to be disabled each time the instrument power is turned off then on. Setting the power up parameter to off disables the control output on power up. Setting the power up parameter to on enables the control output on power up.

To change the power up setting, press the **Control Setup** key. The **CONTROL SETUP** screen is displayed. The control loop indicator is highlighted in the upper left hand corner. Use the **▲** or **▼** key to select Loop 1 or 2. Press the **Enter** or **Next Setting** key. The control setup parameters for that loop appear on the screen. Press the **Next Setting** key until the **Power Up** field is highlighted. Use the **▲** or **▼** key to select on or off. Press the **Enter** or **Next Setting** key to continue with more settings, or press the **Save Screen** key to store the changes in the Model 340. The default setting is Off.

6.3 CONTROL LOOP FILTER

The control loop filter quiets feedback sensor noise that causes instability in the control loop. The control filter works best on electrical noise from the environment or noise in temperature measurement. The control filter can worsen control stability when unwanted disturbances exist in the load temperature because filtering reduces the control loop bandwidth.

The control loop filter uses the same filter window and number of filter points as the input chosen as the control channel. It can be turned on or off independently from the input filter.

To turn the control loop filter on or off, press **Control Setup** to display the **CONTROL SETUP** screen with the control loop indicator highlighted in the upper left hand corner. Use the **▲** or **▼** key to select Loop 1 or 2. Press **Enter** or **Next Setting** to display control setup parameters for that loop. Press **Next Setting** until the **Filtered** field highlights. Use the **▲** or **▼** key to select **ON** or **OFF**. Press **Enter** or **Next Setting** to continue with more settings, or press **Save Screen** to store changes in the Model 340. The default setting is Off.

6.4 CONTROL CHANNEL

A control loop gets feedback from a control sensor located with or near the load. Either standard input can be used for control; optional inputs appear on the setting list if useable. Configure the sensor input used for control to match the sensor type, or as a special type with the correct temperature coefficient. No temperature response curve is needed if the user controls in sensor units. Inputs using a scanner are not recommended for control use.

If the user changes the control channel without selecting a temperature response curve for both the old and new Channel, the Model 340 sets control units to sensor units and picks the sensor units reading from the new control channel as the new Setpoint.

The user can choose which sensor input to use as feedback for each control loop. Loop 1 and Loop 2 settings are independent.

To select a control channel, press **Loop 1** or **Loop 2** to display control parameters for that loop in the lower portion of the display. Press **Control Channel** to highlight the setting field for the control channel sensor input. Use the **▲** or **▼** key to select the sensor input. Press **Enter** to save the change or **Escape** to return to the previous setting. The default setting is A.

6.5 CONTROL MODES

There are two ways to tune a closed loop PID control loop using the Model 340: manual and AutoTune (Paragraphs 2.6 through 2.8). Once the control loop is tuned, the control parameters chosen function for a given temperature range. If more than one temperature range is required, the user must change the control parameters depending on the setpoint temperature. The Model 340 offers several options for doing so including zone control, AutoTune, or internal programming.

Table 6-1. Control Mode Description

Control Mode	Description
MANUAL PID	The instrument can always be used in manual mode. The user changes control parameters based on cooling system experience and knowledge.
AUTO PID	The AutoTune feature can be left on. It computes new control parameters after each setpoint change. Auto PI and Auto P are similar, but they set only P and I or only P.
ZONE	Zone control mode automatically enters pre-selected control parameters when the setpoint is changed to a value outside the present temperature zone (Paragraph 6.8).
OPEN LOOP	Open loop control allows the user to directly set control output. This is not a PID control mode, but it is available for absolute setting of output. Use the Manual Output parameter for open loop settings.

NOTE: Internal programming is not a selection for control mode, but a separate feature that can change PID control parameters and several other parameters. Internal programming overrides Manual PID, but it can be used with Zone control (refer to Paragraph 8.3).

To select a control mode, press the **Control Setup** key and the **CONTROL SETUP** screen appears. The control loop indicator is highlighted in the upper left hand corner. Use the **▲** or **▼** key to select Loop 1 or 2. Press the **Enter** or **Next Setting** key. The control setup parameters for that loop are displayed. Press the **Next Setting** key until the **Ctrl Mode** field is highlighted. Use the **▲** or **▼** key to select the control mode. Press the **Enter** or **Next Setting** key to continue with more settings, or press the **Save Screen** key to store the changes in the Model 340. The default setting is Manual.

6.6 MANUAL SETTING OF PID CONTROL PARAMETERS

This section describes entry of PID control parameters into the Model 340. To select Manual PID control mode, refer to Paragraph 6.5.

6.6.1 Proportional (P)

The proportional parameter (also called gain) is the P part of the PID control equation. It has a range of 0 to 1000 with a resolution of 0.1. Enter a value greater than zero for P to use closed loop control.

To enter a value for P, press **Loop 1** or **Loop 2** to display control parameters for that loop in the lower portion of the display. Press **P** to highlight the setting field for the P. Enter a value with the number keys and press **Enter** to save the change or **Escape** to return to the previous value. Default is 50.

6.6.2 Integral (I)

The integral parameter (also called reset) is the I part of the PID control equation. It has a range of 0 to 1000 with a resolution of 0.1. Setting I to zero turns the reset function off. The I setting is related to seconds by:

$$I_{\text{setting}} = \frac{1000}{I_{\text{seconds}}}$$

To enter a value for I, press **Loop 1** or **Loop 2** to display control parameters for that loop in the lower portion of the display. Press **I** to highlight the setting field for the I parameter. Enter a value with the number keys and press **Enter** to save the change or **Escape** to return to the previous value. Default is 20.

6.6.3 Derivative (D)

The derivative parameter (sometimes called rate) is the D part of the PID control equation. The range of the D setting is 0 to 1000 seconds with a resolution of 1 second. Setting D to zero turns the derivative function off.

To enter a value for D, indicate the desired control loop by pressing the **Loop 1** or **Loop 2** key. The control parameters for that loop appear in the lower portion of the display. Press the **D** key and the setting field for the D parameter is highlighted. Use the number keys to enter a value and press the **Enter** key to save the change or the **Escape** key to return to the previous setting. The default setting is 0.

6.6.4 Manual Output

Manual output is a manual setting of control output. It can function in two different ways depending on control mode. In open loop control mode, the manual output is the only output to the load. The user can directly set control output from the front panel or over computer interface as described in Paragraph 9.3. In Manual PID control mode, the manual output is added directly to the output of the PID control equation. In effect, the control equation operates about the manual output setting.

Manual output setting is in percent of full scale. When using the heater on Loop 1, percent of full scale is defined as current or power on the selected heater range. Manual Output setting range is -100% to +100% with a resolution of 0.01%. Negative values are not recommended with unipolar control outputs.

To enter a manual output value, indicate the desired control loop by pressing the **Loop 1** or **Loop 2** key. The control parameters for that loop appears in the lower portion of the display. Press the **Manual Output** key and the setting field for the manual output parameter is highlighted. Use the number keys to enter a value and press **Enter** to save the change or **Escape** to return to the previous setting. Default setting is 0.

6.7 SELECTING AN AUTOTUNE CONTROL MODE

The Model 340 AutoTune feature automates the tuning process of typical cryogenic systems. Refer to Paragraph 2.8 for additional information about the AutoTune algorithm.

Before initiating AutoTune, setup the cooling system with control sensor and heater capable of closed loop control. Be sure to assign the control sensor with a valid temperature response curve. Assign an appropriate heater range as described in Paragraph 2.7.1. To speed up the AutoTune process, experiment with Manual PID tuning to choose good initial control parameters. If no initial parameters are known, start with the default values of P = 50 and I = 20. It is better to set an initial P value that causes the system to be more active than desired. Starting with a low P value can increase the time and number of attempts required to tune.

Selecting An AutoTune Control Mode (Continued)

There are three AutoTune modes, each with different system characteristics. For most applications, Auto PI is recommended.

Auto P. Sets the P parameter value only. I and D are set to 0 no matter what the initial values are. This mode is recommended for systems that have very long lag times or nonlinearity that prevents stable PI control. Expect some overshoot or undershoot of the setpoint and stable temperature control below the setpoint value.

Auto PI. Sets values for both P and I parameters. D is set to zero. This mode is recommended for stable control at a constant temperature. It may take slightly longer to stabilize after setpoint change than Auto PID. Expect some overshoot or undershoot of the setpoint and stable temperature control at the setpoint value.

Auto PID. Sets values for P, I, and D parameters. D is always set to $\frac{1}{4}$ the integral time in seconds and cannot be changed by the operator. This mode is recommended when setpoint changes are frequent but temperature is allowed to stabilize between changes. Stability at setpoint may be worse than Auto PI in noisy systems. Expect slightly less overshoot or undershoot than the other modes and control at the setpoint value.

Once AutoTune mode is selected, the **Tune** annunciator will turn on when AutoTune is active. No AutoTuning will occur until the setpoint is changed at least 0.5 K. At that time, the **Tune** annunciator changes to **Tuning**, indicating the instrument is gathering data. This process may take from 1 to 17 minutes depending on the system reaction time. The **Tuning** annunciator returns to **Tune** when calculations are complete and new parameter values are stored. The annunciator will also return to **Tune** if the algorithm was unable to complete. Some possible reasons are: setpoint change too small, manual control parameter changed during tuning, heater not turned on, or control sensor curve not selected.

If the controller is not tuned satisfactorily on the first attempt, make several small (2 degree) setpoint changes to see if better parameter values are calculated.

To select AutoTune mode, press the **AutoTune** key. The **AUTOTUNE** screen appears with the control loop indicator highlighted in the upper left-hand corner of the screen. Use the **▲** or **▼** key to select Loop 1 or 2. Press **Enter** or **Next Setting** to advance to tuning mode selection. Only one control loop at a time may use AutoTune. Use the **▲** or **▼** key to select a tuning mode and press **Save Screen** to store the change. The default setting is Manual PID.

6.8 ZONE CONTROL DATA ENTRY

The Model 340 allows the user to establish up to 10 custom temperature zones where the controller automatically uses pre-programmed PID settings and heater range. The user should configure the zones using 1 as the lowest to 10 as the highest zone in kelvin (K). Make a copy of Figure 6-1 to plan your zones, then use the manual to record final zone settings.

To program the zones from the front panel, press the **Zone Settings** key. Use the **▲** or **▼** key to set the Loop to 1 or 2. Use the **Enter** or **Next Setting** keys to advance to the first line of the zone settings. Use the numerical keypad and the **Enter** key to enter new zone values. Parameters that can be specified are Top of the zone (in kelvin), proportional (P), integral (I), derivative (D), Manual Output (in percent), and Heater Range. Enter these parameters for each zone. When complete, press the **Save Screen** key.

Loop: 1		ZONE SETTINGS				
	Top	P	I	D	MOut %	Range
1	100	0.0	0.0	0	0.00	OFF
2	100	0.0	0.0	0	0.00	OFF
3	100	0.0	0.0	0	0.00	OFF
4	100	0.0	0.0	0	0.00	OFF
5	100	0.0	0.0	0	0.00	OFF

Once the zones are programmed, you must place the controller in zone mode. To do this, press the **Control Setup** key. Use the **Next Setting** key to move to the **Control Mode** entry, then use the **▲** or **▼** key to select **Zones**.

Once Zone is turned on, the instrument updates the control settings each time the setpoint is changed to a new zone. If the settings are changed manually, the controller uses the new setting while it is in the same zone, then updates to the zone table settings when the setpoint is changed to a value outside that zone.

This feature is most effective when combined with the ramp rate feature. The user can potentially do a ramp through all 10 zones from 1.4 K to room temperature by only changing the setpoint. The controller automatically changes the PID and heater range settings as the temperature setpoint passes through the different zones.

Zone Setting WorkSheet							
Zone 10	↑	Gain (P)	Reset (I)	Rate (D)	Manual Output	Heater Range	Setpoint: _____ K
Zone 09	↑	Gain (P)	Reset (I)	Rate (D)	Manual Output	Heater Range	Setpoint: _____ K
Zone 08	↑	Gain (P)	Reset (I)	Rate (D)	Manual Output	Heater Range	Setpoint: _____ K
Zone 07	↑	Gain (P)	Reset (I)	Rate (D)	Manual Output	Heater Range	Setpoint: _____ K
Zone 06	↑	Gain (P)	Reset (I)	Rate (D)	Manual Output	Heater Range	Setpoint: _____ K
Zone 05	↑	Gain (P)	Reset (I)	Rate (D)	Manual Output	Heater Range	Setpoint: _____ K
Zone 04	↑	Gain (P)	Reset (I)	Rate (D)	Manual Output	Heater Range	Setpoint: _____ K
Zone 03	↑	Gain (P)	Reset (I)	Rate (D)	Manual Output	Heater Range	Setpoint: _____ K
Zone 02	↑	Gain (P)	Reset (I)	Rate (D)	Manual Output	Heater Range	Setpoint: _____ K
Zone 01	↑	Gain (P)	Reset (I)	Rate (D)	Manual Output	Heater Range	Setpoint: _____ K
0 K	↑	Gain (P)	Reset (I)	Rate (D)	Manual Output	Heater Range	0 K

340-6-1.eps

Figure 6-1. Record of Zone Settings

6.9 USING OPEN LOOP CONTROL

Directly setting control output is called open loop control because there is no feedback from a load sensor to close the control loop. Load temperature, setpoint, and control parameters are ignored. Use open loop control for experiments requiring constant control output regardless of load temperature, for initial cooling system tuning, or for when a computer calculates the control equation and sends output information to the instrument. To use open loop control, set control mode to open (refer to Paragraph 6.5).

When using Control Loop 1 and the heater output, select an appropriate heater range. The manual output parameter sets the control output as percent of full scale current or power on the selected heater range. Manual Output setting range is -100% to +100% with a resolution of 0.01%. Change settings from the front panel or with a computer interface. Negative values are not recommended when using the heater.

When using control Loop 2 and Analog Output 2, manual output parameter sets control output in percent of the ± 10 V range. Manual Output setting range is $\pm 100\%$ with a resolution of 0.01%. Negative values are not recommended unless the output drives a device operating as a heating and cooling source. In most cases, configure Analog Output 2 as unipolar when using it for control output.

To enter a manual output value, press **Loop 1** or **Loop 2** to display control parameters for that loop in the lower portion of the display. Press **Manual Output** to highlight the **MOut** setting field. Enter a value with the number keys and press **Enter** to save the change or **Escape** to return to the previous value. Default is 0.

6.10 SETTING A SETPOINT AND SETPOINT UNITS

The control setpoint is the desired load temperature expressed in temperature or sensor units. Use sensor units if no temperature response curve is selected for the sensor input used as the control channel.

The control setpoint has its own units parameter. When the user selects sensor units as the setpoint units the instrument calculates the control equation in sensor units. It calculates the control equation in temperature with setpoint units set to kelvin or Celsius. The setpoint displays in the selected units. Adjust the P control parameter when changing setpoint units from temperature to sensor. Control channel readings can display in any units. Display units need not match setpoint units.

When changing setpoint units while the control loop is active, the Model 340 converts the control setpoint to the new control units for minimal disruption in control output.

To select setpoint units, press **Control Setup** to display the **CONTROL SETUP** screen with the control loop indicator highlighted in the upper left hand corner. Use the **▲** or **▼** key to select Loop 1 or 2. Press **Enter** or **Next Setting** to display control setup parameters for that loop. Press **Next Setting** until the **Setp Unit** field highlights. Use the **▲** or **▼** key to select units. Press **Enter** or **Next Setting** to continue with more settings, or press **Save Screen** to store changes in the Model 340. Default is Temp K.

Setpoint resolution depends on sensor type and setpoint units. With setpoint expressed in temperature, setpoint resolution is 0.001 degree for setpoints below 1000, and 0.0001 for setpoints below 10. In sensor units, the setpoint resolution matches the display resolution for the sensor input type given in the specifications (Table 1-1). If auto ranging sensor, enter a units multiplier of Ω or $k\Omega$ after the setpoint.

The instrument allows a large setpoint range to accommodate a variety of sensors and units. With setpoint expressed in sensor units, setpoint range is unlimited. The user must determine suitability of a setpoint value. In temperature units, two safety features limit the setpoint value to help prevent load damage load. The first limit is the part of the temperature response curve that shows maximum safe temperature in kelvin for the sensor package. It can be verified by using the **Curve Entry** key (Paragraph 8.1). The user may enter a second global limit (Paragraph 6.13.1). Set it to the maximum safe temperature in kelvin for the entire system. The setpoint is limited to a value less than or equal to the lower of the two safety limits.

After selecting setpoint units and limits, enter the setpoint value. Setpoint has a direct setting key because it changes often. The setpoint value remains on the display any time control parameters for its control loop display. If the setpoint value changes from the number entered when **Enter** is pressed, it is likely the setpoint exceeds one of the above limits is inappropriate for the sensor type.

To enter a setpoint value, press **Loop 1** or **Loop 2** to display control parameters for that loop in the lower portion of the display. Press **Setpoint** to highlight the setpoint setting field. Enter a value with the number

keys and press **Enter** to save the change or **Escape** to return to the previous value. Select a scale factor of n, u, m, k, M, or G. Blank indicates a scale factor of x1. The default is 0.

6.11 SETPOINT RAMPING

The Model 340 generates a smooth setpoint ramp when the setpoint units are expressed in temperature. The user can set a ramp rate in degrees per minute with a range of 0 to 100 and a resolution of 0.1. Once the ramp feature is turned on, its action is initiated by a setpoint change. When a new setpoint is entered, the instrument changes the setpoint temperature from the old value to the new value at the ramp rate. A positive ramp rate is always entered and it is used by the instrument for ramps up and down in temperature.

The ramping feature is useful by itself but it is even more powerful when used with other features. Setpoint ramps are often used with zone control mode. As temperature is ramped through different temperature zones, control parameters are automatically selected for best control. Ramps are initiated and status read back using a computer interface. During computer controlled experiments, the instrument generates the setpoint ramp while the computer is busy taking necessary data. AutoTune does not function during a setpoint ramp because the ramp rate disguises the reaction of the cooling system and no valid tuning data can be taken.

To turn on the ramp feature and set a ramp rate, press the **Ramp** key. The **RAMP SETUP** screen is displayed with the control loop indicator highlighted in the top left hand corner. Use the **▲** or **▼** key to select Loop 1 or 2. Press the **Enter** or **Next Setting** key. The ramp setup information for that loop appears on the screen. Press the **Next Setting** key until the **Ramp** field is highlighted. Use the **▲** or **▼** key to turn the ramp feature On. Press the **Next Setting** key to highlight the ramp rate field. Use the number keys to enter a ramp rate value and press the **Save Screen** key to save the changes in the Model 340. The default setting is Off, 0.1.

To stop a ramp in progress, press the **Ramp** key. The **RAMP SETUP** screen is displayed with the control loop indicator highlighted in the top left hand corner. Use the **▲** or **▼** key to select Loop 1 or 2. Press the **Enter** or **Next Setting** key. The ramp setup information for that loop appears on the screen. Press the **Next Setting** key until the **Ramp** field is highlighted. Use the **▲** or **▼** key to turn the ramp feature **OFF**. Press the **Save Screen** key to stop the ramp. Another method to stop the ramp is to press the **Setpoint** key then immediately press the **Enter** key.

6.12 CONTROL OUTPUT

The output from the PID control equation in Loop 1 is directed to the heater output. The control output from Loop 2 can only be directed to Analog Output 2. This section discusses using the heater output and an Analog Output as a control output.

6.12.1 Heater Output Parameter Settings and Heater Range

Some difficulties may be encountered when configuring the heater output for the first time. It may be difficult to judge the amount of heater power needed to control a cooling system before it tested. Another problem is that the heater output is a current source and not a "power" source. The Model 340 itself adds confusion with the number of available heater ranges.

There are three things that determine the full scale power of a given heater setup: heater resistance, maximum current parameter, and the heater range parameter. Some typical heater output powers are given in Table 6-2 to illustrate how these variables affect heater power.

The resistive heater is not included with the instrument. The cooling system determines the physical size, location, and resistance of the heater (refer to Paragraph 2.4). A heater must be chosen that can dissipate the full scale power available on the highest heater range that may be used. It is recommended to use a heater with resistance between 10 Ω and 100 Ω . The nominal resistance of the heater should be entered into the instrument so the display shows heater parameters properly in power units. An incorrect setting of heater resistance does not change the operation of the heater output.

To enter a heater resistance, press the **Control Setup** key and the **CONTROL SETUP** screen is displayed. The control loop indicator is highlighted in the upper left hand corner. Use the **▲** or **▼** key to select Loop 1. Press the **Enter** or **Next Setting** key. The control setup parameters for that loop appear on the screen. Press the **Next Setting** key until the **Htr Ω** field is highlighted. Use the number keys to enter the resistance of the heater in ohms. Press the **Enter** or **Next Setting** key to continue with more settings, or press the **Save Screen** key to store the changes in the Model 340. The default setting is 25 Ω .

The maximum current parameter is included in the Model 340 to make it more compatible with existing cooling systems. Even though this instrument is capable of sourcing two amps of heater current, there are many control loads that will not tolerate that much current. Lower maximum current settings let the instrument source less current without losing heater ranges or resolution. Maximum current choices: 2 A, 1A, 0.5 A, 0.25 A, and User ("User" setting is only available in main firmware version 01.03.08 and later).

To select a maximum heater current, press the **Control Setup** key and the **CONTROL SETUP** screen is displayed. Press the **More** key until the **CONTROL LIMITS** screen is displayed. The control loop indicator is highlighted in the upper left hand corner. Use the **▲** or **▼** key to select Loop 1. Press the **Enter** or **Next Setting** key. The control setup parameters for that loop appear on the screen. Press the **Next Setting** key until the **Max Htr I** (maximum heater current) field is highlighted. Use the **▲** or **▼** key to select from the list of currents. Press the **Enter** key or next setting key to continue with more settings or press the **Save Screen** key to store the changes in the Model 340. The default setting is 1 A.

A new maximum heater current setting has been added to the 340 with main firmware version 01.03.08 and later. This setting is labeled as "User." When this setting is chosen a **Max I** parameter appears on the display. The **Max I** parameter can be set to a user defined current between 0.1 and 2.0 A to give the user the ability to limit the heater current to values in between the standard, fixed settings of 2 A, 1A, 0.5 A, and 0.25 A. This setting is only available for control loop 1.

Table 6-2. Full Scale Heater Power at Typical Resistance

The Model 340 heater output has five ranges. Each range (below the highest range) reduces the full scale heater output power. The ranges are spaced at approximate decades in power. The heater range setting is available from the normal display so that it can be changed easily during an experiment. For example, with the maximum current set to 1 A and a heater resistance of 25 Ω, the heater output provides the full scale current and power shown in Table 6-3. The range is displayed as the maximum power computed with the maximum current setting and user specified resistance. If the power does not change when you change the range, the voltage compliance is limiting the maximum power. If ranges are skipped, the heater range limit is set.

Heater Resistance	Heater Range	Maximum Current			
		2 A	1 A	0.5 A	0.25 A
10 Ω	5	40 W	10 W	2.5 W	625 mW
	4	4 W	1 W	250 mW	62.5 mW
	3	0.4 W	100 mW	25 mW	6.25 mW
	2	40 mW	10 mW	2.5 mW	625 μW
	1	4 mW	1 mW	250 μW	62.5 μW
25 Ω	5	100 W *	25 W	6.25 W	1.56 W
	4	10 W	2.5 W	625 mW	156 mW
	3	1 W	250 mW	62.5 mW	15.6 mW
	2	100 mW	25 mW	6.25 mW	1.56 mW
	1	10 mW	2.5 mW	625 μW	156 μW
35 Ω	5	71.4 W †	35 W	8.75 W	2.19 W
	4	14 W	3.5 W	875 mW	219 mW
	3	1.4 W	350 mW	87.5 mW	21.9 mW
	2	140 mW	35 mW	8.75 mW	2.19 mW
	1	14 mW	3.5 W	875 μW	219 μW
50 Ω	5	50 W †	50 W	12.5 W	3.12 W
	4	20 W	5 W	1.25 W	312 mW
	3	2 W	500 mW	125 mW	31.2 mW
	2	200 mW	50 mW	12.5 mW	3.12 mW
	1	20 mW	5 mW	1.25 mW	312 μW

* Maximum power available. † Power limited by voltage compliance.

To select a heater output range, indicate Loop 1 by pressing the **Loop 1** key. The control parameters for that loop appear in the lower portion of the display. Press the **Heater Range** key and the setting field for heater range is highlighted. Use the **▲** or **▼** key to select a heater range. Press the **Enter** key to save the change or the **Escape** key to return to the previous setting. The default setting is Off.

NOTE: The control output for Loop 1 must be enabled before the heater can be turned on. Refer to Paragraph 6.2.

The Model 340 has an immediate key operation for turning the heater off. The **Heater Off** key is in a prominent place on the keypad for easy access and it remains active when the keypad is locked. To turn off the heater output, press the **Heater Off** key.

Table 6-3. Example of Max. Current Settings

Range	Current	Power
5	1 A	25 W
4	316 mA	2.5 W
3	100 mA	250 mW
2	31.6 mA	25 mW
1	10 mA	2.5 mW

6.12.2 Analog Output As Loop 2 Control Output

The only control output available for Loop 2 is Analog Output 2. When the analog output is used as a control output it has the same voltage range and resolution as it does when used for any other purpose. Many of the settings and limits on the control setup and control limit screens apply to the Analog Output when used as a control output. Heater range is the most obvious exception.

The analog outputs are variable DC voltage sources that can vary from ± 10 V. The resolution of the analog output is 1.25 mV or 0.0125% of full scale. The output can source up to 100 mA of current providing a maximum of 1 W of power. They can drive a resistive load of no less than 100 Ω . The output is short protected so the instrument is not be harmed if the heater resistance is too small. It is not recommended because the additional load on instrument power supplies will cause noise on internal circuits.

Paragraph 3.5.7 describes two ways to use an Analog Output as a control output. If the output is used directly as a resistive heater driver, be sure the heater has a resistance of 100 Ω or more. The maximum power out is 1 W at 100 Ω . If the output is used to program an external power supply, the input resistance of the voltage programming input on the supply must be 100 Ω or greater. Setup and operation are otherwise similar.

To select control output as a source for an Analog Output, press the **Analog Outputs** key. The analog output indicator is highlighted in the upper left hand corner. Use the **▲** or **▼** key to select analog output 2. Press the **Enter** or **Next Setting** key until the **Mode** field is highlighted. Use the **▲** or **▼** key to select **LOOP**. Press **Enter** or **Next Setting** to continue with more settings or the **Save Screen** key to save the changes to the Model 340.

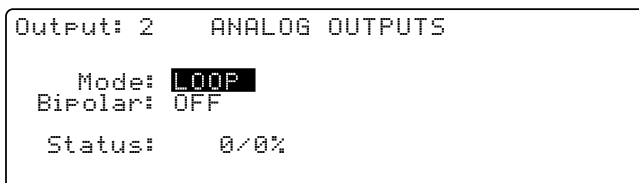

It is recommended to set the Analog Output to unipolar mode. Few applications can use bipolar control output. A thermoelectric cooling element is one example of a control actuator that can utilize a bipolar control output. The AutoTune feature will not operate with Loop 2 configured for Bipolar Control.

To set unipolar operation for an Analog Output, press the **Analog Outputs** key. The analog output indicator is highlighted in the upper left hand corner. Use the **▲** or **▼** key to select analog output 2. Press the **Enter** or **Next Setting** key until the **Bipolar** field is highlighted. Use the **▲** or **▼** key to select **OFF**. Press the **Enter** or **Next Setting** key to continue with more settings or the **Save Screen** key to save the changes to the Model 340.

Once the Analog Output is setup, the control loop must be setup. Control channel, control mode, PID control parameters, setpoint units, and setpoint are described in the heater output Paragraph 6.12.1. The AutoTune feature will only work with one loop at a time. Heater range and other features noted in Table 1-1 are not available. Control output limits, other than heater range limit, described in Paragraph 6.13, work with any control output.

6.13 CONTROL OUTPUT LIMITS

Control limits were added to the Model 340 as added protection to prevent parameter settings that can damage the cooling system.

6.13.1 Setpoint Limit

Setpoint temperature limit is a global limit for a control loop. Setpoint values above the limit are rejected and the setpoint defaults to the limit value. The limit is entered in kelvin and works with setpoint units of kelvin or Celsius. The limit does not work when sensor units are chosen for the setpoint.

The Model 340 turns off the control output if the temperature of the control sensor exceeds the global limit. The global setpoint limit works along with the individual limits that can be entered in a temperature response curve. The curve limits are only active when a sensor using that curve is chosen as a control sensor while the global limit is active all the time. The lower of the two is used to limit the setpoint.

To change the setpoint temperature limit, press the **Control Setup** key. The control loop indicator is highlighted in the upper left hand corner. Use the **▲** or **▼** key to select a control loop and press the **Enter** or **Next Setting** key. The control setup parameters for that loop appears on the screen. Press the **Next Setting** key until the setpoint field under the limits heading is highlighted. Use the number keys to enter the maximum setpoint in kelvin. Press the **Enter** or **Next Setting** key to continue with more settings, or press the **Save Screen** key to store the changes in the Model 340. The default setting is 475 K.

6.13.2 Control Output Slope Limit

Some experiments can not tolerate fast changes in control output. The slope limit feature keeps changes in control output below a user specified rate of change. There is a different limit for rising and falling slope. The rising slope limit is shown as +Slope, the falling slope limit is shown as -Slope. Both are set in percent of output current per second. The setting range is 0 to 100 with a resolution of 0.1.

To change the output slope limit, press the **Control Setup** key. The control loop indicator is highlighted in the upper left hand corner. Use the **▲** or **▼** key to select a control loop and press the **Enter** or **Next Setting** key. The control setup parameters for that loop appear on the screen. Press the **Next Setting** key until the slope field under the limits heading is highlighted. Use the number keys to enter the maximum slope in percent per second. Press the **Enter** or **Next Setting** key to continue with more settings, or press the **Save Screen** key to store the changes in the Model 340. The default setting is 0 (off).

6.13.3 Heater Range Limit

Accidental heater range settings are possible because the heater range can be set directly from the normal display of the Model 340. A heater range limit feature is intended to prevent heater range settings that could harm the control load. The heater range can be set to the user specified limit setting but not above. The range limit is accessed through control setup operation so it can not be changed unintentionally. The range limit is only available for the heater output on Loop 1. The full scale power of a given heater range depends on the maximum current setting so the maximum current parameter should be set before the range limit.

To change the heater range limit, press the **Control Setup** key. The control loop indicator is highlighted in the upper left hand corner. Use the **▲** or **▼** key to select a control Loop 1 and press the **Enter** or **Next Setting** key. The control setup parameters for that loop appear on the screen. Press the **Next Setting** key until the range field under the limits heading is highlighted. Use the **▲** or **▼** key to select a range limit. Press the **Enter** or **Next Setting** key to continue with more settings, or press the **Save Screen** key to store the changes in the Model 340. The default setting is the highest range.

This Page Intentionally Left Blank

CHAPTER 7

ANALOG OUTPUT, DIGITAL I/O, ALARM, AND RELAY OPERATION

7.0 GENERAL

The Model 340 has several hardware features that enable it to interface with the experimental environment. These hardware features defined the operation of the controller as related to temperature measurement and control, but can also be controlled manually by the user from the front panel or over computer interface.

Analog outputs are described in Paragraph 7.1. Digital inputs and outputs (I/O) are described in Paragraph 7.2. Input alarms are described in Paragraph 7.3. Finally, high and low relays are described in Paragraph 7.4.

7.1 ANALOG OUTPUTS

The Model 340 has two analog outputs, Analog Output 1 and Analog Output 2. They are voltage sources that can be used to output a voltage representation of sensor input reading. Analog Output 2 can also be used as the control output for Loop 2 as described in Paragraph 7.1.3. The user can select the source of the analog output data and scale the relationship of data reading to output voltage, independently for the two analog outputs.

The analog outputs are variable DC voltage sources that can vary from ± 10 V. The resolution of the analog output is 1.25 mV or 0.0125% of full scale. The output can source up to 100 mA of current providing a maximum of 1 W of power. They can drive a resistive load of no less than 100 Ω . The output is short protected so the instrument is not harmed if the load resistance is too small. This is not recommended because the additional load on the power supplies in the instrument causes noise on the internal circuits. The analog output connector and pinouts are shown in Figure 10-5.

To set up an analog output, first select an operating mode. Other parameters depend on the mode that is selected. A list of analog output operating modes is shown to the right.

OFF	Output voltage is set to 0 volts.
INPUT	Analog output voltage is tied to a sensor input.
LOOP	Control Loop 2 Control output (Analog Output 2 only).
MANUAL	Manual setting of the analog output voltage.

To select an analog output mode, press the **Analog Outputs** key. The **ANALOG OUTPUTS** screen is displayed. With the output number highlighted in the top left corner, use the **▲** or **▼** key to select an analog output. Press the **Next Setting** key until the **Mode** field is highlighted. Use the **▲** or **▼** key to select the desired mode. Press the **Next Setting** or **Enter** key to make changes to other parameters, or press the **Save Screen** key to store the changes. The default setting is Off.

The analog output is capable of setting a bipolar (positive or negative) voltage. When the bipolar parameter is on, the analog output varies between ± 10 V. Many inputs may be damaged by a negative voltage. Setting the bipolar parameter to off prevents the analog output from setting a negative output voltage. Only voltages between 0 and +10 V are set. The bipolar setting is used for all of the analog output modes.

To set the bipolar parameter, press the **Analog Outputs** key. The **ANALOG OUTPUTS** screen is displayed. With the output number highlighted in the top left corner, use the **▲** or **▼** key to select an analog output. Press the **Next Setting** key until the bipolar field is highlighted. Use the **▲** or **▼** key to select **ON** or **OFF**. Press the **Next Setting** or **Enter** key to make changes to other parameters or press the **Save Screen** key to store the changes. The default setting is Off.

7.1.1 Input Mode for Analog Output

When input mode is chosen for an analog output, there are several other parameters to set. The sensor input must be chosen and the data source from the input. Sensor input setup including operation of the linear equation is discussed in Paragraph 5.3.3.

Input	Sensor Input used for input reading data. The default setting is A.
Source	Source of data from the input. The default is Temp K. Temp K Kelvin temperature reading from an input. Temp C Celsius temperature reading from an input. Sensor Sensor units reading from an input. Linear Linear equation data from an input.
Low	Reading data value that corresponds to -10 V when bipolar, 0 V when unipolar. The value may be set as a six digit floating point number. The default setting is 0.
High	Reading data value that corresponds to +10 V. The value may be set as a six digit floating point number. The default setting is 1000.

Once the sensor input data is directed to an analog output, there are two other parameters that must be set. The low and high parameters define the 6-digit sensor input reading values that comprise the bottom and top of the analog output voltage range. The scale factor can be selected as n, u, m, k, M, or G. Blank indicates a scale factory of x1. These parameters are included so the user can control the range and sensitivity of the output. The example below demonstrates how the high and low parameters work.

To configure an analog output, select the **Mode** and **Bipolar** setting, then continue with the other parameters listed above. Highlight the parameter field and select the appropriate setting values. Press the **Save Screen** key when finished to save the changes. The **Value %** field that appears is not a settable parameter in this mode. It reports the analog output status in percent of full scale.

7.1.2 Example of Low and High Parameter Setting

With the analog output set to linear mode, the temperature input data and voltage output data are related as shown:

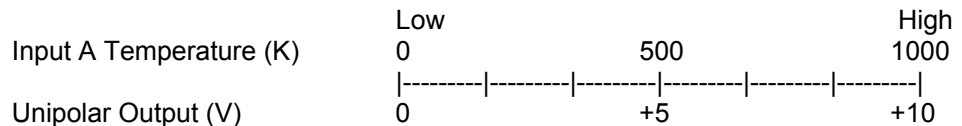

The first figure results in a wide temperature range but sensitivity is poor. The resulting sensitivity is 0.01 V/K or 10 mV/K.

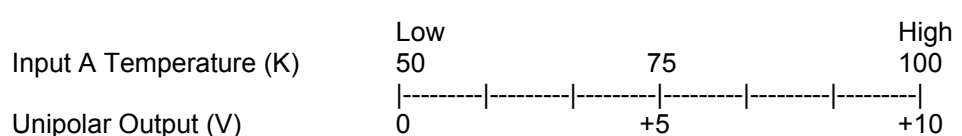

If the application does not require a wide temperature range, the user can change the value of the low and high parameters to improve sensitivity. This setup has a narrow range with much improved sensitivity of 0.2 V/K or 200 mV/K. Please note that in any application, the resolution of the analog output voltage is always 1.25 mV as specified.

The second figure shows how sensitivity improves when working at liquid nitrogen temperature (77 K).

7.1.3 Loop 2 Mode for Analog Output 2

Discussion about using Analog Output 2 as the control output for Loop 2 is contained in the control operation chapter. Loop 2 must be chosen as the mode for analog output 2 and the bipolar setting should match the capability of the control system. It is recommended to set the Analog Output to unipolar mode. Few applications can use bipolar control output. A thermo-electric cooling element is one example of a control actuator that can utilize a bipolar control output.

7.1.4 Manual Mode Operation of the Analog Outputs

During manual operation, the user can set the voltage of an analog output giving them a controlled voltage source. In manual mode, all analog output parameters are ignored except the bipolar setting and the users output setting value.

The setting value is given in percent of full scale. With bipolar on, a setting value of -100 % causes an output voltage of -10 V, and a setting value of +100 % causes an output voltage of +10 V. With bipolar off (unipolar) a setting value of 0 % causes an output voltage of 0 V, and a setting value of +100 % causes an output voltage of +10 V. Negative setting values cause an output voltage of 0 V if bipolar is off.

The resolution of the analog output hardware is 1.25 mV or 0.0125% of full scale. Setting resolution of the output value is 0.01 %.

To set an analog output voltage, press the **Analog Outputs** key and set the mode to manual and set bipolar setting as described in Paragraph 7.1. Press the **Next Setting** key until the value field is highlighted. Use the number keys to enter the desired output, then press the **Enter** key. Press the **Save Screen** key to store the changes. The default value is 0%.

7.2 DIGITAL INPUTS AND OUTPUTS (I/O)

The Model 340 has six digital inputs and five digital outputs. The digital inputs and outputs can be used to monitor instrument status in a pre-programmed mode of operation or they can also be used in manual mode to control and monitor external events. The connector pinout and hardware information about the digital signals is provided in Paragraph 3.7. The digital signal lines are protected against short circuit and over voltage but it is not recommended to expose the terminals to ESD or voltages higher than +5 V or lower than ground provided on the Digital I/O connector.

7.2.1 Digital Output Modes

Model 340 digital outputs have four modes of operation.

To select a digital output mode, press the **Options** key. The **DIGITAL I/O** screen appears

OFF	All digital outputs set to zero.
ALARMS	Used to indicate the alarm status of the sensor inputs.
MANUAL	Set by user from the front panel or computer interface.
SCANNER	Used with an external scanner (refer to Paragraph 5.4).

with the output mode highlighted. Use the ▲ or ▼ key to select the desired mode. Press the **Enter** or **Next Setting** key to advance to other settings, or press the **Save Screen** key to store changes. The default setting is Off.

7.2.2 Digital Outputs in Alarm Mode

In alarm mode, the digital outputs report the alarm status of the sensor input alarms. The digital output is low, logic 0, to indicate no alarm condition and high, logic 1, to indicate an alarm condition exists. Alarms for a given sensor input must be turned on for this feature to operate. The sensor input alarms are mapped to the digital output signals as follows:

Input Alarm:	Any Other *	B High	B Low	A High	A Low
Digital Output Number:	DO5	DO4	DO3	DO2	DO1
Digital I/O Connector Pin:	5	4	3	2	1

* "Any Other" indicates that an alarm is active on any one of the installed optional inputs.

7.2.3 Digital Outputs in Scanner Mode

Digital outputs can be used to report the scan channel when an external scanner is being used. The digital outputs must be put in scanner mode as described in Paragraph 7.2.1. External scanner operation is described in Paragraph 5.4.

7.2.4 Digital Outputs in Manual Mode

In manual mode, the digital outputs are controlled directly by the user. The digital output signals can be set to any combination of high (logic 1) or low (logic 0). Digital output can only be set using the **0** and **1** keys. For example: a setting of 00011 causes digital outputs 1 and 2 to be high (logic 1) and digital outputs 3, 4, and 5 to be low (logic 0).

To manually set a digital output, set the digital output mode to manual as described in Paragraph 7.2.1. Press the **Options** key and the **Digital I/O** screen appears. Press the **Next Setting** key until the **Reading** line is highlighted. Use the number keys, 0 and 1, to enter a setting that corresponds to the digital output numbers shown below the setting on the display. Press the **Save Screen** key to store the changes. The default value is 00000.

7.2.5 Digital Input Modes

The digital input signals are always read by the Model 340. Their status is always available from the front panel or over computer interface. The only defined application of the digital inputs is during external scanner operation (refer to Paragraph 5.4). If external scanner operation is not being used, the inputs are considered to be in manual mode.

7.3 INPUT ALARMS

Each input of the Model 340 has a high and low alarm setting. Input reading data in temperature units, sensor units, or from linear equation can be compared to the alarm values. If a reading is higher than the high alarm setting the high alarm is active for the input. If a reading is lower than the low alarm setting the low alarm is active for the input. The alarm feature can be enabled or disabled for each individual input.

Active alarms are indicated on the display with an annunciator. The **Alarm** annunciator indicates that there is an input alarm enabled. An **Alarming** annunciator indicates that an enabled alarm is active. An audible beeper can also sound to indicate an alarm is active. The audible beeper can be turned off for all alarms. One or more sets of high and low alarms can be directed to the high and low alarm relays. Parameters on the **RELAY & BEEPER SETUP** screen must be changed for the alarm relays and beeper to be active, as described in Paragraph 7.4.

The alarms can operate in latching or non-latching mode. In non-latching mode, an active alarm becomes inactive when the alarm condition is corrected. This mode is often used in control applications where an alarm event is triggered inside the normal operating range of the input sensor. In latching mode an active alarm is held active even after the alarm condition is corrected. This mode is most often used as a safety feature to discontinue an external activity if the input sensor is outside of a safe operating range. The **Alarm Reset** key is used to reset a latched alarm.

7.3.1 Enabling an Input Alarm

To enable an input alarm, press the **Alarm Setup** key. The **ALARM SETTINGS** screen appears with the input letter in the top left hand corner. Use the **▲** or **▼** key to select an input. Press the **Enter** or **Next Setting** key to show the alarm parameters for that input. Press the **Next Setting** key until the **Enable** field is highlighted. Use the **▲** or **▼** key to turn the alarm on or off for that input. Use the **Next Setting** key to make more changes, or press the **Save Screen** key to store the changes. The default setting is Enable Off.

7.3.2 Selecting an Input Alarm Source

Once an input is selected, a data source from that input is set. The following selections are available:

TEMP K	Temperature in Kelvin.
TEMP C	Temperature in Celsius.
SENSOR	Raw sensor units as read from the input sensor.
LINEAR	Linear equation output, refer to Paragraph 5.3.3.

To select an input alarm data source, press the **Alarm Setup** key.

The **ALARM SETTINGS** screen appears with the input letter in the top left hand corner. Use the **▲** or **▼** key to select an input. Press the **Enter** or **Next Setting** key to show the alarm parameters for that input. Press the **Next Setting** key until the source field is highlighted. Use the **▲** or **▼** key to select a source from that input. Use the **Next Setting** key to make more changes or press the **Save Screen** key to store the changes. The default setting is Temp K.

7.3.3 Input Alarm High and Low Settings

High alarm and low alarm setting values for an input alarm are set with a 6-digit value and an additional scale factor. The scale factor can be selected as n, u, m, k, M, and G. Blank indicates a scale factory of x1. If the source is changed, the settings return to their default values. The instrument does not restrict the range or resolution of the alarm setting.

To select an input alarm high or low setting, press the **Alarm Setup** key. The **ALARM SETTINGS** screen appears with the input letter in the top left hand corner. Use the **▲** or **▼** key to select an input. Press the **Enter** or **Next Setting** key to show the alarm parameters for that input. Press the **Next Setting** key until the **High** or **Low** setting field is highlighted. Use the number keys to enter a value for the setting and press the **Enter** key. Press the **Enter** key. Use the **▲** or **▼** key to select a scale factor: n, μ , m, k, M, and G. Blank indicates a scale factory of x1. Press the **Next Setting** key to make more changes, or press the **Save Screen** key to store the changes. The default values are Low = 0.0 and High = 1000.

7.3.4 Input Alarm Latching

To enable an alarm latching, press the **Alarm Setup** key. The **ALARM SETTINGS** screen appears with the input letter in the top left hand corner. Use the **▲** or **▼** key to select an input. Press the **Enter** or **Next Setting** key to show the alarm parameters for that input. Press the **Next Setting** key until the enable field is highlighted. Use the **▲** or **▼** key to turn alarm latching on or off for that input. Use the **Next Setting** key to make more changes or press the **Save Screen** key to store the changes. The default setting is Off.

7.3.5 Input Alarm Relay Setup

The two relays on the Model 340 can be used for high and low alarm outputs. One or more sets of high and low input alarms can be directed to the high and low relays. To direct the alarms from an input to the relays, set the relay parameter on the **ALARM SETTINGS** screen to On. Parameters on the **RELAY & BEEPER SETUP** screen must also be changed, as described in Paragraph 7.4.

When the alarms directed to a relay are not active (status Off), the relay is in the normal position. If any one of the alarms directed to a relay is active (status On), the relay switches to the opposite position. Relay connections are shown in Figure 3-7.

To direct an alarm pair to the relays, press the **Alarm Setup** key. The **ALARM SETTINGS** screen appears with the input letter in the top left hand corner. Use the **▲** or **▼** key to select an input. Press the **Enter** or **Next Setting** key to show the alarm parameters for that input. Press the **Next Setting** key until the enable relay is highlighted. Use the **▲** or **▼** key to turn the relay parameter on or off for that input. Use the **Next Setting** key to make more changes or press the **Save Screen** key to store the changes. The default setting is Off.

7.3.6 Input Alarm Reset

The **Alarm Reset** key performs the immediate action of resetting all latched alarms. If any alarm is latched active and the alarm condition has been corrected, pressing the **Alarm Reset** key deactivates the alarm. If the alarm condition is not corrected, the alarm is not deactivated. Non-latching alarms deactivate when the alarm condition is corrected without the Alarm Reset function.

7.3.7 Audible Beeper

The audible alarm beeper can be turned on or off for the entire instrument. To turn on or off the audible alarm beeper, press the **Options** key and then press the **More** key and the **RELAYS & BEEPER SETUP** screen appears. Press the **Next Setting** key until the beeper field highlights. Use the **▲** or **▼** key to turn the beeper on or off and press the **Save Screen** key to store the change. The default setting is On.

7.4 HIGH AND LOW RELAYS

The Model 340 has one high and one low relay. See Figure 3-7. They are most commonly associated with the alarm feature discussed in Paragraph 7.3. The relays can also be put in manual mode and controlled directly by the user from the front panel or over computer interface. Relay parameters are shown on the **Relays and Beeper Setup** screen, which is accessed by pressing the **Options** key, then pressing the **More** key. The relay and beeper **Status** shown on the right side of the screen is for monitoring only and cannot be changed by the user.

OFF	Relay is set to Off
MANUAL	Relay manual control (Paragraph 7.4.2)
ALARMS	Relay triggered by alarm (Paragraph 7.3.5)

7.4.1 Selecting a Relay Mode

To select a relay mode, press the **Options** key and then press the **More** key and the **RELAYS & BEEPER SETUP** screen appears. Press the **Next Setting** key until the appropriate relay mode field is highlighted. Use the **▲** or **▼** key to select a mode for that relay. Use the **Next Setting** or **Enter** key to make more changes or press the **Save Screen** key to store the changes. The default setting is Off.

7.4.2 Manually Setting a Relay

To manually control a relay it must be in the manual mode, as described in Paragraph 7.4.1. A relay setting of "Off" puts the relay in its normal state, while "On" puts the relay in the opposite state.

To change a relay setting, press the **Options** key and then press the **More** key and the **RELAYS & BEEPER SETUP** screen appears. Press the **Next Setting** key until the appropriate relay setting field is highlighted. Use the **▲** or **▼** key to select on or off for that relay. Use the **Next Setting** or **Enter** key to make more changes or press the **Save Screen** key to store the changes. The default setting is Off.

CHAPTER 8

INSTRUMENT PROGRAMMING

8.0 GENERAL

The Model 340 has a powerful processor, user interface, and special programming features. Internal programming is not intended to replace computer interface operation, and in most cases the two complement each other. Programming features include entering a temperature response curve, saving and restoring instrument parameters, and internal programming that allows the instrument to run temperature profiles.

This chapter covers front panel curve entry in Paragraph 8.1, SoftCal™ in Paragraph 8.2), internal programming in Paragraph 8.3, and data card operations in Paragraph 8.4.

8.1 CURVE ENTRY FROM THE FRONT PANEL

Enter a temperature response curve into the Model 340 in several ways: Field install a CalCurve with a Data Card or order it factory-installed; enter a user-generated curve from the front panel; create a SoftCal curve with the SoftCal feature (Paragraph 8.2); or load a curve with a computer interface (refer to Chapter 9).

8.1.1 Curve Numbers and Storage

The Model 340 has 20 standard curve locations; numbered 1 through 20. At present, only curve locations 1 through 10 are occupied by curves; the others are reserved for future updates. If a standard curve location is in use, the curve can be viewed using the edit operation. Standard curves can not be changed by the user, and reserved locations are not available for user curves.

The Model 340 has 40 user curve locations numbered 21 through 60. Each location can hold from 2 to 200 data pairs (breakpoints) including a value in sensor units and a corresponding value in Kelvin. Using fewer than 200 breakpoints will not increase the number of available curve locations. SoftCal generated curves are stored in user curve locations.

No specific curve endpoints are required. The instrument will show an error message on the display if the sensor input is outside the range of the breakpoints.

Each curve has a set of parameters that are used for identification and to allow the instrument to use the curve effectively. The parameters must be set correctly before a curve can be used for temperature conversion or temperature control.

Please note that if instrument power is lost when new curves are being stored or erased (Save Screen has been pressed), all user curves may be lost.

8.1.2 Front Panel Curve Entry Operations

There are three operations associated with front panel curve entry: Edit curve, Copy curve copy, Erase curve; as detailed below.

Edit curve	Edit allows the user to see any curve and enter or edit a curve at any user curve location. Standard curves cannot be changed (Paragraph 8.1.3).
Copy curve	Copy allows the user to copy a curve from any location to any user curve location. Curves cannot be copied into standard curve locations (Paragraph 8.1.4).
Erase curve	Erase allows the user to delete a curve from any user curve location. Standard curves cannot be erased (Paragraph 8.1.5).

To begin a curve operation, press the **Curve Entry** key and the above selections appear. Press the **Next Setting** key until the desired operation is highlighted and press the **Enter** key. A curve screen appears with the curve number highlighted. Change to the desired curve number with the **▲** or **▼** key, then press the **Enter** key to begin the desired curve operation.

8.1.3 Front Panel Curve Edit

The **Edit curve** operation can be used to enter a new curve or edit an existing user curve. Entering the identification parameters associated with the curve is as important as entering the breakpoints. Only user curves (numbers 21 to 60) can be changed. Standard curves can only be viewed with the edit operation.

Name:	Identify curves with names of up to 15 characters. The curve name cannot be changed during front panel curve entry. To change curve names, enter them over computer interface. The default curve name is User xx, where xx is the curve number.			
SN:	Identify specific sensors with serial numbers of up to 10 characters. The serial number field accepts both numbers and letters, but the instrument front panel enters only numbers. To enter both numbers and letters enter curves over computer interface. The default is blank.			
Limit	A setpoint temperature limit can be included with every curve. If the control sensor is an input using a curve and operating in temperature units, then the setpoint cannot exceed the limit entered with the curve. The default is 375 K.			
Format:	The instrument must know the data format of the curve breakpoints. Different sensor types use different data formats. The standard sensor inputs require one of the formats below. The range and resolution specified are not always available at the same time. Practical range and resolution depend on the sensor type.			
	Format	Description	Sensor Units Full Scale Range	Sensor Units Maximum Resolution
	V/K	Volts vs. Kelvin	10 (V)	0.00001 (V)
	Ω/K	Resistance vs. Kelvin	10 k (Ω)	0.00001 (Ω)
	log R/ K	log Resistance vs. Kelvin	4 (log R)	0.00001 (log R)
	log R / log K	log Resistance vs. log Kelvin	4 (log R)	0.00001 (log R)
	mV/K	mV vs. Kelvin	±100 (mV)	0.00001 (mV)
Coeff:	Enter an appropriate temperature for proper temperature control. A positive coefficient indicates the sensor signal increases with increasing temperature. A negative coefficient indicates the sensor signal decreases with increasing temperature. The instrument derives the temperature coefficient from the first two breakpoints. If it is set improperly, check the first two breakpoints.			

Table 8-1. Recommended Curve Parameters

Type	Lake Shore Model No.	Units	Format	Limit (K)	Coefficient	Recommended Sensor Resolution
Silicon Diode	DT-470	Volts	V/K	475	Negative	0.00001 (V)
GaAlAs Diode	TG-120	Volts	V/K	325	Negative	0.00001 (V)
Platinum 100	PT-100	Ohms	Ohm/K	800	Positive	0.001 (Ω)
Platinum 1000	PT-100	Ohms	Ohm/K	800	Positive	0.01 (Ω)
Rhodium-Iron	RF-100	Ohms	Ohm/K	325	Positive	0.001 (Ω)
Carbon-Glass	CGR-1-1000	Ohms	logR/K	325	Negative	0.00001(logR)
Cernox	CX-1030	Ohms	logR/K	325	Negative	0.00001(logR)
Ruthenium Oxide	-	Ohms	logR/K	325	Negative	0.00001(logR)
Germanium	GR-200A-100	Ohms	logR/K	325	Negative	0.00001(logR)

Once curve identification parameters are entered, it is time to enter curve breakpoints. A breakpoint is the representation of the sensor calibration that is stored in the instrument. Each breakpoint consists of one value in sensor units and one temperature value in kelvin. From 2 to 200 breakpoints can be entered as a curve. No special endpoints are required. Sensor units are defined by the format setting in Table 8-1.

Breakpoint setting resolution is six digits in temperature. Most temperature values are entered with 0.001 resolution. Temperature values of 1000 K and greater can be entered to 0.01 resolution. Temperature values below 10 K can be entered with 0.0001 resolution. Temperature range for curve entry is 1500 K.

Setting resolution is also six digits in sensor units. The curve format parameter defines the range and resolution in sensor units as shown in Table 8-1. The sensor type determines the practical setting resolution. Table 8-1 lists recommended sensor units resolutions. For most sensors, additional resolution is ignored.

The breakpoints should be entered with the sensor units value increasing as point number increases. There should not be any breakpoint locations left blank in the middle of a curve. The search routine in the Model 340 interprets a blank breakpoint as the end of the curve.

NOTE: If the curve you wish to enter has similar parameters to an existing curve, first copy the similar curve (as described in Paragraph 8.1.5) to a new location, then edit the curve to the desired parameters.

To enter a curve, press the **Curve Entry** key. Press the **Next Setting** key until **Edit curve** is selected, then press the **Enter** key. Use the **▲** or **▼** key to select the desired curve number to edit, then press the **Enter** key.

```

Edit Curve: #23
Name: DT-470      1: 0.09062 475.000
SN: D20496       2: 0.10191 470.000
Limit: 499.900   3: 0.11356 465.000
Format: U/K      4: 0.12547 460.000
Coeff: Neg.      5: 0.13759 455.000
(I)Insert        (D>Delete

```

You may now enter the serial number (SN), Limit, Format, and Sensor/Temp (K) breakpoint pairs. Use the **Previous Setting** and **Next Setting** keys to move from one edit field to the next. Use the **I** and **D** keys to Insert or Delete lines from the breakpoint field. When the edit is complete, press the **Save Screen** key. The **Saving user curves...** message appears for a few seconds. If you do not wish to save the new curve, press the **Cancel Screen** key.

8.1.4 Front Panel Curve Copy

Curves can be copied from one location inside the Model 340 to another. This is a good way to make small changes to an existing curve. Curve copy may also be necessary if the user needs the same curve with two different temperature limits or needs to extend the range of a standard curve. The curve that is copied is always preserved.

NOTE: Copying an internal curve from one location to another is not the same as copying (or downloading) a curve from a data card to the Model 340. The data card curve downloading procedure is provided in Paragraph 8.4.

To copy a curve, press the **Curve Entry** key. Press the **Next Setting** key until **Copy curve** is selected, then press the **Enter** key.

```

Copy Curve: #1   To: #21
Name: DT-470     1: 0.09062 475.000
SN: Standard     2: 0.10191 470.000
Limit: 499.900   3: 0.11356 465.000
Format: U/K      4: 0.12547 460.000
Coeff: Neg.      5: 0.13759 455.000

```

Change to the desired curve number with the **▲** or **▼** key, then press the **Enter** key. The cursor jumps to the To: selection. Again, use the **▲** or **▼** key to select the user curve number (21 to 60) the curve will be copied to. (Empty user curves have zeros for data.)

NOTE: The copy routine allows you to overwrite an existing user curve. Please ensure the curve number you are writing to is correct before proceeding with curve copy.

Once the curve number to copy to has been selected, press the **Enter** key. The following message is displayed: **Press SAVE SCREEN to copy, CANCEL SCREEN to abort.** If you press the **Save Screen** key, the **Saving user curves...** message appears for a few seconds, then the display returns to the **CURVE ENTRY** menu. If you press the **Cancel Screen** key, the curve is not copied and you are returned to the **CURVE ENTRY** menu.

8.1.5 Front Panel Curve Erase

When curves are no longer needed, they can be edited over or erased. Curves erase sets all identification parameters to default and blanks all breakpoint values.

To erase a curve, press the **Curve Entry** key. Press the **Next Setting** key until **Erase curve** is selected, then press the **Enter** key. Change to the desired curve number with the **▲** or **▼** key, then press the **Enter** key. The following message is displayed: **Press SAVE SCREEN to erase, CANCEL SCREEN to abort.** If you press the **Save Screen** key, the **Saving user curves...** message appears for a few seconds, then the display returns to the **CURVE ENTRY** menu. If you press the **Cancel Screen** key, the curve is not erased and you return to the **CURVE ENTRY** menu.

8.2 SOFTCAL™

The Model 340 performs inexpensive sensor calibrations with a two algorithms called SoftCal. These algorithms work with DT-400 Series Silicon Diode sensors and Platinum Sensors. They create a new temperature response curve from the standard curve and known data points entered by the user. The new curve loads into one of the 40 user curve locations (21 through 60). These paragraphs describe the data points needed from the user and the expected accuracy of the resulting curves.

Both DT-400 and Platinum SoftCal algorithms require an existing standard curve in the Model 340. When the user enters the sensor type to calibrate, the correct standard curve is selected. When calibration is complete, the user selects the new curve for an input; the Model 340 does not automatically choose the newly generated curve for either input.

Enter calibration data points (normally measured at easily reached temperatures). Each algorithm operates with one, two, or three calibration points. Accuracy increases with more points.

There are two ways to get SoftCal calibration data points: ❶ The user record the response of an unknown sensor at well controlled temperatures, or ❷ The user buys a Lake Shore SoftCal calibrated sensor. There are advantages to both methods.

- ❶ **User:** When the user can provide stable calibration temperatures with the sensor installed, SoftCal calibration eliminates errors in the sensor measurement as well as the sensor. Thermal gradients, instrument accuracy, and other measurement errors can be significant. Calibration can be no better than user-supplied data.
- ❷ **Purchased:** Lake Shore sensors with SoftCal calibration include a set of calibration points in the calibration report. Lake Shore generates SoftCal calibration points in a controlled calibration facility for best accuracy. The user enters the calibration points into the Model 340 to generate a curve. If the user buys the CalCurve service with the calibrated sensor, the factory generates the curve for later entry like any other curve.

8.2.1 SoftCal and Silicon Diode Sensors

Lake Shore Silicon Diode Sensors incorporate remarkably uniform sensing elements that exhibit precise, monotonic, and repeatable temperature response. For example, the Lake Shore DT-470 Series of silicon diode sensors has a repeatable temperature response from 2 K to 475 K. These sensors closely follow the Standard Curve 10 response and routinely interchange with one another. SoftCal is an inexpensive way to improve the accuracy of an already predictable sensor.

NOTE: Standard Curve 10 is the name of the temperature response curve, not its location inside the Model 340. Standard Curve 10 is stored in Curve Location #1 in the Model 340.

A unique characteristic of DT-400 Series diodes is that their temperature responses pass through 28 K at almost exactly the same voltage. This improves SoftCal algorithm operation by providing an extra calibration data point. It also explains why SoftCal calibration specifications are divided into two temperature ranges, above and below 28 K. See Figure 8-1.

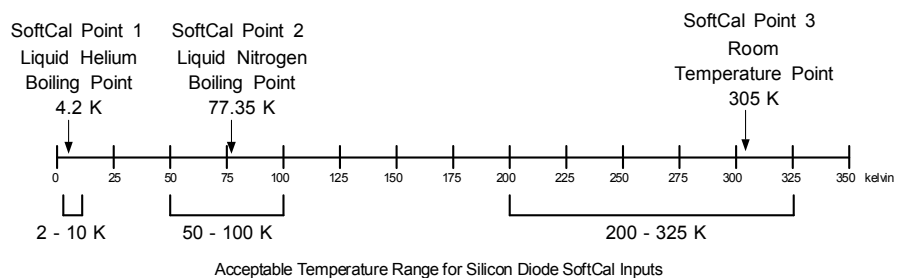

Figure 8-1. SoftCal Temperature Ranges for Silicon Diode Sensors

Point 1: Calibration data point at or near the boiling point of helium, 4.2 K. Temperatures outside 2 K to 10 K are not allowed. This data point improves between the calibration data point and 28K. Points 2 and 3 improve temperatures above 28 K.

Point 2: Calibration data point at or near the boiling point of nitrogen (77.35 K). Temperatures outside 50 K to 100 K are not allowed. This data point improves accuracy between 28 K and 100 K. Points 2 and 3, together, improve accuracy to room temperature and above.

Point 3: Calibration data point near room temperature (305 K). Temperatures outside the range of 200 K to 350 K are not allowed.

8.2.2 SoftCal Accuracy with Silicon Diode Sensors

SoftCal allows an abbreviated calibration, based on 1, 2, or 3 points, to generate a voltage-versus-temperature curve over the useful range of a Lake Shore DT-400 Series silicon diode sensor.

A SoftCal calibration is only as good as the accuracy of the calibration points. The accuracies listed for SoftCal assume ± 0.05 K for 77.35 K (liquid nitrogen) and 305 K (room temperature) points, and ± 0.01 K for 4.2 K (liquid helium). Users performing the SoftCal with silicon diodes and Lake Shore instruments should note that liquefied nitrogen and ice point temperatures can vary as much as ± 0.5 K. Use calibrated standard sensors if possible. The boiling point of liquid helium, though accurate, is affected by atmospheric pressure.

Perform one-point SoftCal calibrations for applications under 30 K at liquid helium (4.2 K). Accuracy for the DT-470-SD-13 diode is ± 0.5 K from 2 K to <30 K with no accuracy change above 30 K.

Perform two-point SoftCal calibrations for applications above 30 K at liquid nitrogen (77.35 K) and room temperature (305 K). Accuracy for the DT-470-SD-13 diode sensor is as follows:

± 1.0 K from 2 K to <30 K (no change below 30 K)	
± 0.25 K from 30 K to <60 K	± 0.25 K from 345 K to <375 K
± 0.15 K from 60 K to <345 K	± 1.0 K from 375 to 475 K

Perform three-point SoftCal calibrations at liquid helium (4.2 K), liquid nitrogen (77.35 K), and room temperature (305 K). Accuracy for the DT-470-SD-13 diode sensor is as follows:

± 0.5 K 2 K to <30	
± 0.25 K 30 K to <60 K	± 0.25 K 345 K to <375 K
± 0.15 K 60 K to <345 K	± 1.0 K 375 to 475 K

8.2.3 SoftCal and Platinum Sensors

The platinum sensor is a well-accepted temperature standard because of its consistent and repeatable temperature response above 30 K. SoftCal gives platinum sensors better accuracy than their nominal matching to the DIN 43760 curve.

Use one, two, or three calibration data points. If using one point, the algorithm shifts the entire curve up or down to meet the single point. If using two points, the algorithm has enough information to tilt the curve, achieving good accuracy between the data points. The third point extends the improved accuracy to span all three points.

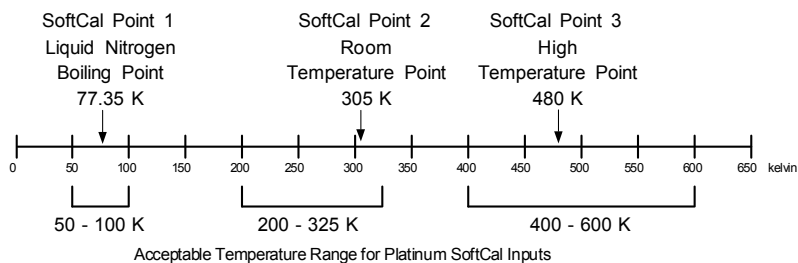

Figure 8-2. SoftCal Temperature Ranges for Platinum Sensors

Point 1: Calibration data point at or near the boiling point of nitrogen (77.35 K). Temperatures outside 50 K to 100 K are not allowed.

Point 2: Calibration data point near room temperature (305 K). Temperatures outside 200 K to 350 K are not allowed.

Point 3: Calibration data point at a higher temperature (480 K). Temperatures outside 400 K to 600 K are not allowed.

8.2.4 SoftCal Accuracy with Platinum Sensors

The SoftCal procedure makes small adjustments to the DIN curve so that the resulting curve matches the resistance-versus-temperature characteristic of the individual sensor more closely.

A SoftCal calibration is only as good as the accuracy of the calibration points. The accuracies listed for SoftCal assume ± 0.05 K for 77.35 (liquid nitrogen) K and 305 K (room temperature) points. If you are performing the SoftCal yourself with Lake Shore instrumentation, be aware that liquefied nitrogen and ice point temperatures can vary as much as ± 0.5 K. Use a calibrated standard sensor if possible. One-point SoftCal calibrations with platinum sensors have no specified accuracy.

Perform two-point SoftCal calibrations for applications above 70 K at liquid nitrogen (77.35 K) and room temperature (305 K). Accuracy for the PT-102, PT-103, or PT-111 platinum sensor is as follows:

± 250 mK from 70 K to 325 K $\approx \pm 500$ mK from 325 K to $\approx \pm 1400$ mK at 480 K
(DIN Class A or Class B tolerance)

Perform three-point SoftCal calibrations at liquid nitrogen (77.35 K), room temperature (305 K), and high temperature (480 K). Accuracy for the PT-102, PT-103, or PT-111 platinum sensor is ± 250 mK from 70 K to 325 K, and ± 250 mK from 325 K to 480 K.

8.2.5 Creating a SoftCal Calibration Curve

Once the calibration data points have been obtained, you may create a SoftCal calibration. Press **SoftCal**.

Use the **▲** or **▼** key to select the Standard curve that the SoftCal will be based on. Press the **Enter** key. Use the numerical keypad to enter the location where the new user curve will be stored. Press the **Enter** key. Use the numerical keypad to enter from 1 to 10 digits for a sensor serial number. Press the **Enter** key. Enter the first temperature and corresponding sensor reading. Press the **Enter** key. Repeat the process for the next two temperature points. When complete, press the **Save Screen** key. You see a brief **Generating Curve** message, followed by a longer **Saving user curves...** message. The SoftCal curve has now been generated. The new curve has the name **SCAL XXY** where **XX** is DT for diodes and PT for platinum, and **Y** specifies how many points were used to generate the curve. Once the curve is generated, you must remember to select the curve for the desired input. Refer to Paragraph 5.2.

```

SOFTCAL
Std. Curve: 1 DT-470
User Curve: 21 SN:
                Temp.  Reading
Point 1:  4.2000  1.62622
Point 2:  77.3500  1.02032
Point 3:  305.000  0.50691

```

8.3 INTERNAL PROGRAMMING

Internal programming allows the user to enter a set of simple instructions, called a program, into the instrument. Some instructions mimic front panel operations; like setpoint ramps and control parameter changes. Other instructions are for timing and decision making. The instrument can run the instructions in an internal program without operator interaction. Since program status can be monitored with a computer interface, internal programs can be used during computer controlled experiments.

The internal program feature works with control Loop 1. There is enough memory in the Model 340 to hold 100 programming instructions. The instructions can be put in up to 10 different program locations. The program locations are provided to help organize internal programming operations. As many as 100 and as few as 2 or 3 instructions can be placed in a single program location. The total number of instructions in all ten program locations must not exceed 100. An End instruction, described in the next paragraph, is included in each program location but does not take one of the 100 memory locations.

The following paragraphs provide details about the programming instructions offered in the Model 340, then gives an example of how to put the instructions together into a program. A second example illustrates how programs in two or more program locations can be used together.

8.3.1.8 Wait

Temperature control systems often need time for temperature control to stabilize or temperature gradients to settle out. A Wait instruction is used in a program to add a time delay.

Hours: Hours taken for wait, set from 0 to 23.	Wait	>	Hours: 0
Minutes: Minutes taken for wait, set from 0 to 59.			Minutes: 0
Seconds: Seconds taken for wait, set from 0 to 59.			Seconds: 0

For a fixed wait time, set the hours, minutes, and seconds parameters. The program will not proceed to the next instruction until the wait time is over, but the temperature control functions will operate normally.

8.3.1.9 Settle

Temperature control systems often need time for temperature control to stabilize or temperature gradients to settle out. The Settle instruction is used in a program to add a time delay or let the control temperature settle.

Hours: Hours to wait (0 to 23).	Settle	>	Hours: 0
Minutes: Minutes to wait (0 to 59).			Minutes: 0
Seconds: Seconds to wait (0 to 59).			Seconds: 0
Band: Temperature threshold for stability, positive peak value from 0 to 10 K with 0.1 K resolution.	$\pm 0.00000K$		Band:

To wait for control stability, the time parameters and Band are used together to set the stability criteria. Stability is reached when the temperature of the control input sensor does not deviate from the setpoint by more than the Band value for the set time. The Band is set in Kelvin. The setpoint units must be in temperature for this instruction to operate.

8.3.1.10 Repeat/End Repeat

The Repeat and End Repeat instructions work together to allow repetitive operations without repeating instructions. The Repeat instruction is placed at the beginning of a group of instructions that are repeated and the End Repeat is placed at the end. The group of instructions is repeated as many times as the user specifies in the count parameter of the Repeat instruction.

Count: Number of times to repeat the instructions between this instruction and its appropriate end repeat.	Repeat	>	Count: 1
Infinite Loop: Repeat the instructions an infinite amount of times; On or Off.	End Repeat	>	Infinite Loop: OFF

NOTE: Nest up to 10 Repeat/End Repeat sets.

8.3.1.11 Call

The Call instruction provides a way to put small programs together into a larger program. A set of often repeated instructions, called a subprogram, may be entered into a program location. Another program, called a main program, can call one or more subprograms in any sequence.

A subprogram must occupy an entire program location. It can only be called from the beginning of the program location and must run to the End instruction which returns control to the calling program. A subprogram can call another subprogram but should not call itself or a subprogram that calls it.

The main program is in the program location that is run from the internal program setting screen. It begins with the first instruction in the program location. The program in location 1 does not have to be the main program. The internal program stops when it reaches the End instruction of the main program.

Program: Program location to be called.	Call	>	Program: 1
--	-------------	---	-------------------

8.3.1.12 End

An End instruction is included in each of the 10 program locations. It does not take any of the 100 instruction memory locations. When a program location is empty, the End instruction occupies the first instruction line.

When a program runs from the internal program setting screen, the instrument processes each instruction in sequence until it reaches the End instruction where the program stops, then returns to normal operation. Parameters (like setpoint and P, I, and D values) set in the program retain the last value set by the program.

If using the Call instruction is used, the End instruction returns control to the calling program.

End > |

8.3.1.13 NOP

The NOP instruction holds only memory space. When a running program encounters a NOP instruction, it ignores it, but the instruction occupies a memory location. The instruction is most often used to save a memory location in a for another instruction to be selected later.

NOP > |

8.3.2 Internal Programming Operations

Below is a list of the four internal programming operations initiated from the **PROGRAM MODE** screen:

Run program	Run a program.
Terminate program	End a program run and return instrument to normal operation.
Edit program	Enter or change a program.
Clear program memory	Clear program memory space.

Store and retrieve program memory from a data card as well. Refer to Paragraph 8.4.

Read DataCard *	Copy programs from a data card to internal program memory.
Write DataCard *	Copy the contents of configurable memory including program memory to a data card.

*These operations are performed from the data card setting screen.

To begin a program operation, press the **Program** key. You see the following display.

Press the **Next Setting** or **Previous Setting** key until the desired operation is highlighted, then press the **Enter** key. A setting screen for that operation appears on the display. It may then be necessary to choose one of the ten program locations before continuing.

```

PROGRAM OPERATION
Run Program
Terminate Program
Edit program
Clear program memory

Status: Stopped
Program: 1, Line 0, Mem: 100/100
    
```

8.3.3 Enter or Edit an Internal Program

Program editing initiates as an internal programming operation. Select one of the ten program locations from the program edit screen. New programs appear empty, with End as the first instruction. Program entry follows the sequence, insert a NOP, change the NOP to the desired instruction, enter appropriate instruction parameters.

To edit a program, press **Program** to display the **PROGRAM OPERATION** screen. Press **Next Setting** to highlight the **Edit Program** line. Press **Enter** to display the edit screen with the program number field highlighted. Use the **▲** or **▼** key to select the desired program, then press **Enter** to display instructions existing in that program location (if any).

The **Edit Program** screen is divided into two halves. The left half is a list of instructions in the program location and the right half shows parameters for a single instruction when the instruction is highlighted. Enter instructions like any other data table. **Next Setting** and **Previous Setting** move up and down the table.

There are three table entry commands listed at the bottom of the screen that make program entry more convenient. Insert (I), Delete (D) and Paste (P) manipulate the instructions within a program. The table entry commands use the **P**, **I**, and **D** keys normally associated with those control parameters. The commands work only in the left screen.

Insert adds instruction space to a program location in order to add instructions. **Delete** deletes selected instructions. **Paste** copies an instruction and its parameters to another line in a program.

To insert a NOP to make room for a new instruction, highlight the instruction field on the left side of the display. Use **Next Setting** or **Previous Setting** to select the line to receive the inserted instruction. Press the **I** key (located in the control section of the keypad) to enter a NOP in the highlighted line.

To change a NOP to a desired instruction, highlight the instruction field on the left side of the display. Use **Next Setting** or **Previous Setting** to select the desired line of the program location. Use the **▲** or **▼** key to select the desired instruction. Press **Next Setting** to advance to the next instruction line.

To set instruction parameters, highlight the desired instruction on the left half of the display to display the parameters for that instruction on the right half of the display. Press **Enter** to highlight the parameters. Use **Next Setting** or **Previous Setting** to move up and down the list of parameters. Set them like parameters on a normal setting screen. Press **Save Screen** key to return to the left half of the display.

8.3.4 Saving a Program

When a program is entered, it is automatically saved. The **Save Screen** key must be pressed when changing from the right side of the display to the left, or instruction parameter settings will be lost.

8.3.5 Summary of Key Operation in Program Mode

Next Setting/ Previous Setting	Move up and down the set of instructions on the left or parameters on the right side of the setting screen.
Up (▲)/Down (▼)	Change a parameter setting.
Enter	Move from left to right side of setting screen.
Save Screen	Move from right to left side of setting screen.
I (Insert)	Insert an instruction line when on the left side.
D (Delete)	Delete an instruction line when on the left side.
P (Paste)	Insert the previously deleted instruction when on the left side.

8.3.6 Example of an Internal Program (Example 1)

This example illustrates the typical use of an internal program. It represents the preconditioning of a sample in temperature. Figure 8-3 illustrates the program loaded into location 1. To run this program, follow the run procedure detailed in Paragraph 8.3.8, and specify Program 1.

```
Edit Program #01
1 Parameters >| Channel: A
                Mode: MANUAL PID
                P: 50.0
                I: 20.0
                D: 12
                Htr Range: 25W
2 Ramp SP Abs. >| Setpoint : 50.000K
                Hours : 0
                Minutes : 7
                Seconds : 0
                Rate : 0.0K/m
3 Settle >| Hours: 0
                Minutes: 0
                Seconds: 30
                Band: ±1.00000K
4 Repeat >| Count: 3
                Infinite Loop: OFF
5 Ramp SP Rel. >| Dev.: -10.000K
                Hours : 0
                Minutes: 1
                Seconds: 0
                Rate : 0.0K/m
6 Wait >| Hours: 0
                Minutes: 1
                Seconds: 0
7 Ramp SP Rel. >| Dev.: +10.000K
                Hours: 0
                Minutes: 1
                Seconds: 0
                Rate: 0.0K/m
8 Wait >| Hours: 0
                Minutes: 1
                Seconds: 0
9 End Repeat >|
10 Ramp SP Abs. >| Setpoint: 10.000K
                Hours: 0
                Minutes: 4
                Seconds: 0
                Rate: 0.0K/m
11 End >|
```

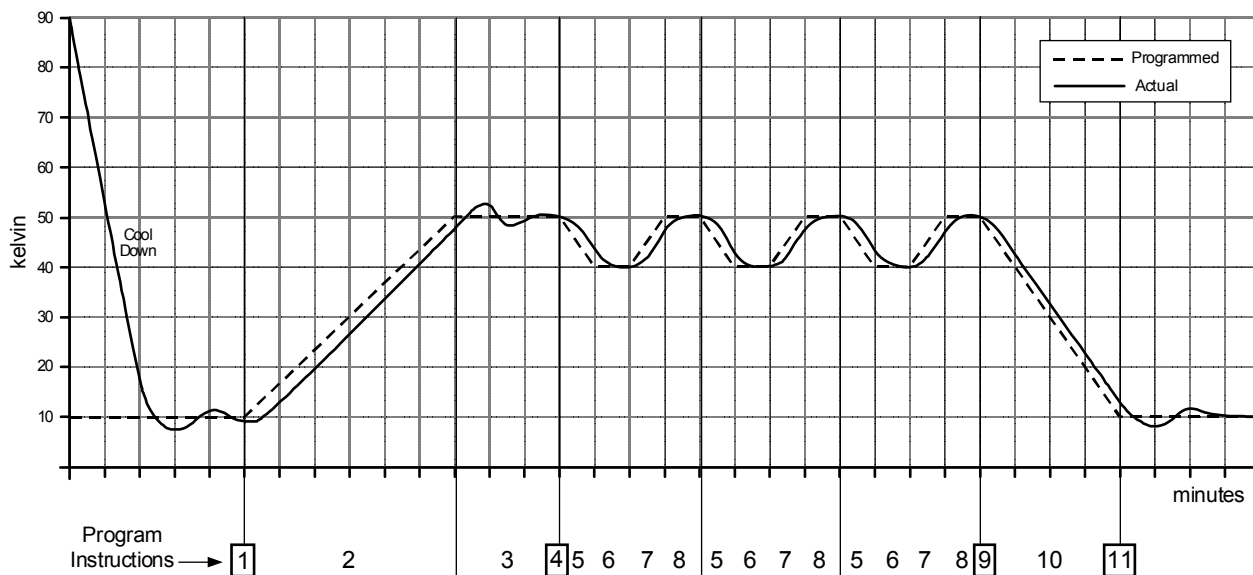
340-8-3.CVS

Figure 8-3. Sample Program #1

8.3.7 Example of Using Subprograms (Example 2)

This is an example of a short subprogram that could easily be called from the program in example 1. It opens then closes the high relay before returning to the calling program. The subprogram should be stored in program location 2. To use this subprogram, insert a Call instruction with Program parameter set to 2 in the first example program. Run the first example again and listen for the relays to click at the appropriate time.

Edit Program #02

```

1 Relays      >| High: ON
                | Low: OFF

2 Wait        >| Hours: 0
                | Minutes: 0
                | Seconds: 30

3 Relays      >| High: OFF
                | Low: OFF

4 End         >|

```

8.3.8 Run an Internal Program

To run a program already entered into memory, press the **Program** key. Use the **Next Setting** key to highlight **Run program**. Press the **Enter** key. Use the **▲** or **▼** key, or the numerical keypad, to enter the program number. Press the **Enter** key. The display returns to normal and the program begins to execute. If you wish to monitor where the program is, press the **Program** key. The **Status** line displays **Running** and the **Line** number the program is currently at is displayed. You should monitor the controller closely the first time you run a new program to ensure it performs as expected.

8.3.9 Stop a Running Program

To stop a program already running, press the **Program** key. Use the **Next Setting** key to highlight **Terminate program**. Press the **Enter** key. The program stops immediately. To verify the program has terminated, press the **Program** key. The **Status** line displays **Stopped** and the **Line** number the program is currently on is zero.

8.3.10 Clear Internal Program Memory

To clear the internal program memory, press the **Program** key. Use the **Next Setting** key to highlight **Clear program memory**. Press the **Enter** key. You now see the message **Press SAVE SCREEN to clear, CANCEL SCREEN to abort**. Press the **Save Screen** key to clear the internal program memory.

8.4 DATA CARD OPERATION

The Model 340 has a data card slot located on the left side of the real panel, underneath the power input assembly. Although the pins in the data card slot conform to the PCMCIA standard, the slot is not a PCMCIA interface. The data card slot has the ability to read and write to Flash Cards. The data cards available from Lake Shore are detailed in Paragraph 10.2 – Accessories.

Data card operation is provided in the following paragraphs. Data logging is described in Paragraph 8.4.1. Reading from a data card is described in Paragraph 8.4.2. Writing to a data card is described in Paragraph 8.4.3. Finally, erasing a data card is described in Paragraph 8.4.4.

8.4.1 Data Logging To A Data Card

The Model 340 can store reading data or control data in an SRAM Data Card with the data logging feature. Stored data can be viewed on the display or read over computer interface at a later time.

Data is taken in groups called records. Each record consists of a timestamp and up to four points of data in any combination of the input readings, setpoints or control outputs. The Model 340 can utilize SRAM Data Cards from 64K to 1M byte. Larger data cards can be used but only the first 1M byte is utilized by the instrument. Table 8-2 indicates the maximum number of records that can be stored in a 1MB SRAM Data Card based on the number of data points in a record.

Table 8-2. Storage Capability for a 1MB Data Card

Records	Data Points
65000	1
45000	2
34000	3
28000	4

To enter the data log functions, insert an SRAM Data Card into the data card slot and press the **Data Card** Key. The **Identifying Card...** message is displayed, followed by the **DATA CARD** screen. It shows the recognized Data Card type and its capacity on the bottom of the screen, together with its battery and the WriteProtect switch status.

Note: Batteries are not included with SRAM Data Cards purchased from Lake Shore.

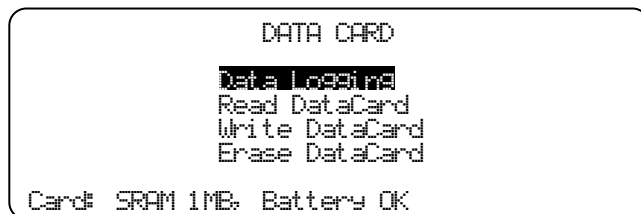

Highlight **Data Logging** and press the **Enter** key. The **DATA LOGGING** screen is displayed with five menu items. Number of Records already logged in the SRAM Data Card and its logging status are also shown on the bottom of the screen. Use the **Next Setting** or **Previous Setting** key to select each menu item.

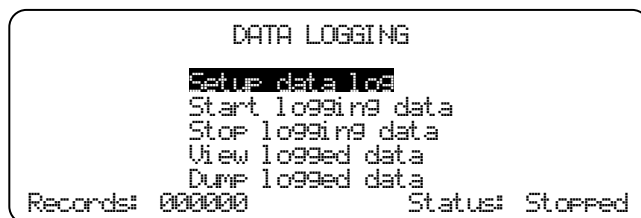

8.4.1.1 Log Setup

To setup the data log, highlight **Setup data log** and press the **Enter** key. The **SETUP DATA LOG** screen appears.

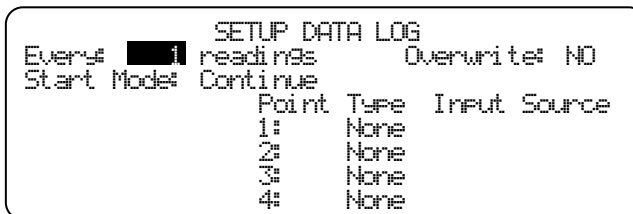

- Every** Sets the interval for storing records as one record every 1 to 3600 readings or one record every 1 to 3600 seconds. The interval number is set first followed by units.
- readings/seconds** Selects the unit of the logging rate. Every 20 readings equals 1 second, because the Model 340 updates the readings 20 times a second.
- Start Mode** Selecting **Clear** clears old records before starting data logging. Selecting **Continue** continues data logging and adds new records to existing data.
- Overwrite**
 - Yes:** Data logging continues beyond the maximum number of records specified and overwrites old records with new.
 - No:** Data logging stops at the maximum number of records specified.
- Type** Specifies the data type of the specified **Point**. Five data types are available to log:
 - (1) Input reading
 - (2) SP1 (Setpoint of Control Loop 1)
 - (3) SP2 (Setpoint of Control Loop 2)
 - (4) Out1 (Output of Control Loop 1)
 - (5) Out2 (Output of Control Loop 2)

If no data logging is necessary for the specified **Point**, select **None**.

Note: Changing **Type** will erase stored records.
- Input** Specifies Input channel to log. This field is available only if **Input** is specified in the **Type** field.

Note: Changing **Input** will erase stored records.
- Source** Specifies the source of the selected Input channel. TEMP K, TEMP C, MAX, MIN, SENSOR, LINEAR can be chosen. This field is available only if **Input** is specified in the **Type** field.

Note: Changing **Source** will erase stored records.

8.4.1.2 Starting Data Logging

To start data logging, highlight **Start logging data** and press the **Enter** key. The data logging starts immediately and the **Status** on the right bottom of the **DATA LOGGING** screen will indicate **Logging**. The **Record** counter on the left bottom of the same screen will increment as records are stored in the SRAM Data Card.

NOTE: Data logging will not start if the Data Card is write protected, or it has full data and **Continue** is selected in the **Start Mode** with **No Overwrite**.

8.4.1.3 Stopping Data Logging

To stop data logging, highlight **Stop logging data** and press the **Enter** key. The data logging stops immediately and the **Status** on the right bottom of the **DATA LOGGING** screen will indicate **Stopped**. The **Record** counter on the left bottom of the same screen shows the number of records that are currently stored in the SRAM Data Card.

8.4.1.4 Viewing the Logged Data

To view the logged data on the display, highlight **View logged data** and press the **Enter** key. The **VIEW DATA LOG** screen will appear.

```

VIEW DATA LOG
Record 1 of 28332
Date 12/15/2000 Time 14:37:20.370
Point Type Input Source Value
1: Input A TEMP K 284.945 K
2: SP1 285.000 K
3: Out1 + 69.1% @ 25W
4: Input A SENSOR +0.55507 V
    
```

Record Specifies the record number. The first record is numbered 1. Use the **▲** or **▼** key to increase or to decrease the record number. The number keys followed by **Enter** can also be used to enter a record number directly.

8.4.1.5 Dumping the Logged Data to the Serial I/O Port

Logged data can also be transferred to the Serial I/O port. Highlight **Dump logged data** and press the **Enter** key. The following message will appear on the display.

```

Dumping logged records...
Record 1 of 28332
Press ESCAPE to abort.
    
```

To stop dumping, press the **Escape** key.

The dumped data has the following format.

<Timestamp>, <Point 1>, <Point2>, <Point3>, <Point4> [term]

where,

<Timestamp> Shows the timestamp of the record. Refer to the DATETIME? query for the string format.

<Point n> The Model 340 decodes the stored data depending on the point type.

- (1) Input <value>, <status>
 <value> is in either K or C or sensor unit depending on the input source. <status> indicates input status and can have a value from 0 to 255. Each bit has its own meaning as shown below.
 Bit 7: 1 = Input is DISABLEd.
 Bit 6: 1 = Input has NOCURVe.
 Bit 5: 1 = Input is S-OVER.
 Bit 4: 1 = Input is S-ZERO.
 Bit 3: 1 = Input is T-OVER.
 Bit 2: 1 = Input is T-UNDR.
 Bit 1: 1 = Old reading. (*)
 Bit 0: 1 = Invalid reading.
- (2) SP1/2 <value>
 <value> is in either K or C or sensor unit depending on the setpoint unit.
- (3) Out1 <value>, <current/power>, <heater range>
 <value> is in %. <current/power> = 1 for current, 2 for power. <heater range> indicates the heater range in W.
- (4) Out2 <value>
 <value> is in %.
- (5) None 0.0

(*) This bit is typically set if the input is configured as one of Negative Voltage Coefficient Resistance Temperature Device with constant voltage excitation and when its thermal compensation is ON. In this situation, this bit is set in every other reading, which indicates 10 readings update per second.

[term] Currently specified Serial Terminator.

8.4.1.6 Line Power Loss

When line power is lost while the Model 340 is logging data, it resumes the data log sequence when power is restored, if the battery in the SRAM Data Card has enough voltage to keep the logged data.

8.4.2 Reading From A Data Card

To read a data card, place the card into the slot, then press the **DataCard** Key. The **Identifying Card...** message is displayed, followed by the **DATACARD** screen. Press the **Next Setting** key until **Read DataCard** is highlighted.

Once **Read DataCard** is highlighted, press the **Enter** key.

Use the **Next Setting** or **Previous Setting** key to select which type of information is to be read from the data card.

```

DATACARD
Data Logging
Read DataCard
Write DataCard
Erase DataCard

Card: 128KB Flash, M340 Config
    
```

```

READ DATACARD
Configuration
Settings
Programs
User Curves
CalCurves
M340 Main Code

Card: 128KB Flash, M340 Config
    
```

Configuration	Reads configuration, programs, and curves from the data card, saves user curves, then resets the Model 340 to the new configuration.
Settings	Reads the settings from the data card and resets the Model 340.
Programs	Reads the programs from the data card and reset the Model 340. The programs may then be accessed by pressing the Program key.
User Curves	Reads the user curves from the data card and saves the curves to memory. Press Curve Entry to access the curves.
CalCurves	Reads the selected CalCurve from the data card. Select the CalCurve from the data card and the curve location in the Model 340.
M340 Main Code	Reads the Model 340 Main Code from the data card and resets the Model 340. Used to receive factory software updates.

8.4.3 Writing To A Data Card

To write to a data card, place the card into the slot, then press the **DataCard** Key. The **Identifying Card...** message is displayed, followed by the **DATACARD** screen. Press the **Next Setting** key until **Write DataCard** is highlighted. Press the **Enter** key.

Use the **Next Setting** or **Previous Setting** key to select which type of information is to be written to the data card.

```

WRITE DATACARD
Configuration
Cal Curves
M340 Main Code

Card: 128KB Flash, M340 Config
    
```

Configuration	Writes the configuration, programs, and curves to data card.
CalCurves	Writes the selected CalCurve to the data card. Write as many individual curves to the data card as there is room in card memory.
M340 Main Code	A data card required to copy the Model 340 Main Code.

8.4.4 Erasing A Data Card

To erase a data card, place the card into the slot, then press the **DataCard** Key. The **Identifying Card...** message is displayed, followed by the **DATACARD** screen. Press the **Next Setting** key until **Erase DataCard** is highlighted. Press the **Enter** key. The message **Press SAVE SCREEN to continue, CANCEL SCREEN to abort** is displayed. If you press the **Save Screen** key, the data card is erased. If you press the **Cancel Screen** key, the erasure is canceled.

This Page Intentionally Left Blank

CHAPTER 9

REMOTE OPERATION

9.0 GENERAL

Two computer interfaces are provided with the Model 340 Temperature Controller. Either of these interfaces permit remote operation of the Model 340. The first is the IEEE-488 Interface described in Paragraph 9.1. The second is the Serial Interface described in Paragraph 9.2. The two interfaces share a common set of commands described in Paragraph 9.3. Only one of the interfaces should be used at a time.

9.1 IEEE-488 INTERFACE

The IEEE-488 Interface is an instrumentation bus with hardware and programming standards designed to simplify instrument interfacing. The IEEE-488 Interface of the Model 340 complies with the IEEE-488.2-1987 standard and incorporates the functional, electrical, and mechanical specifications of the standard unless otherwise specified in this manual.

All instruments on the interface bus must be able to perform one or more of the interface functions of TALKER, LISTENER, or BUS CONTROLLER. A TALKER transmits data onto the bus to other devices. A LISTENER receives data from other devices through the bus. The BUS CONTROLLER designates to the devices on the bus which function to perform. The Model 340 performs the functions of TALKER and LISTENER but cannot be a BUS CONTROLLER. The BUS CONTROLLER is your digital computer which tells the Model 340 which functions to perform.

The IEEE-488 interface capabilities of the Model 340 Controller are listed below as well as in mnemonic format on the rear panel of the controller.

- **SH1:** Source handshake capability
- **RL1:** Complete remote/local capability
- **DC1:** Full device clear capability
- **DT0:** No device trigger capability
- **C0:** No system controller capability
- **T5:** Basic TALKER, serial poll capability, talk only, unaddressed to talk if addressed to listen
- **L4:** Basic LISTENER, unaddressed to listen if addressed to talk
- **SR1:** Service request capability
- **AH1:** Acceptor handshake capability
- **PP0:** No parallel poll capability
- **E1:** Open collector electronics

9.1.1 IEEE-488 Interface Settings

If using the IEEE-488 interface, the user must set the IEEE Terminator, End Or Identify (EOI), and Address. Press the **Interface** key to display the **COMPUTER INTERFACE** screen. The user has the option to change the Terminator (CR/LF, LF/CR, CR, LF, or none), EOI (On or Off), and Address (1–32). Use the ▲ or ▼ key make selections. Use the **Next Setting** key to advance to the next parameter. Finally, use the **Save Screen** key to accept the changes or the **Cancel Screen** key to decline the changes. The default settings are CR LF, EOI On, and 12.

9.1.2 IEEE-488 Command Structure

The Model 340 supports several command types. These commands are divided into three groups.

1. Bus Control – Described in Paragraph 9.1.2.1.
 - a. Universal
 - (1) Uniline
 - (2) Multiline
 - b. Addressed Bus Control
2. Common – Described in Paragraph 9.1.2.2.
3. Interface and Device Specific – Described in Paragraph 9.1.2.3.

9.1.2.1 Bus Control Commands

A Universal Command is a command that addresses all devices on the bus. Universal Commands include Uniline and Multiline Commands. A Uniline Command (Message) is a command which results in a single signal line being asserted. The Model 340 recognizes two of these messages from the BUS CONTROLLER: Remote (REN) and Interface Clear (IFC). The Model 340 sends one Uniline Command (SRQ).

REN (Remote) – Puts the Model 340 into a remote mode.

IFC (Interface Clear) – Stops current operation on the bus.

SRQ (Service Request) – Tells the bus controller that the Model 340 needs interface service.

A Multiline Command involves a group of signal lines. All devices equipped to implement such commands do so simultaneously when the command is transmitted. These commands are transmitted with the Attention (ATN) line asserted low. There are two Multiline commands recognized by the Model 340:

LLO (Local Lockout) – LLO is sent to instruments to lock out (prevent the use of) their front panel controls.

DCL (Device Clear) – DCL is used to clear Model 340 interface activity and put it into a bus idle state.

Finally, Addressed Bus Control Commands are Multiline commands that must include the Model 340 listen address before they respond to the command in question. Note that only the addressed device responds to these commands. The Model 340 recognizes three of the Addressed Bus Control Commands:

SDC (Selective Device Clear) – The SDC command performs essentially the same function as the DCL command except that only the addressed device responds.

GTL (Go To Local) – The GTL command is used to remove instruments from the remote mode. With some instruments, GTL also unlocks front panel controls if they were previously locked out with the LLO command.

SPE (Serial Poll Enable) and **SPD (Serial Poll Disable)** – Serial polling is used to obtain the Service Request (SRQ) Status Register. This status register contains important operational information from the unit requesting service. The SPD command ends the polling sequence.

9.1.2.2 Common Commands

Common Commands are addressed commands intended to make some commonality between instruments on the bus. Instruments that comply with the IEEE-488.2-1987 standard share these commands and their format. Common commands begin with an asterisk (*). They are usually related to “bus” and “instrument” status and identification. Common query commands end with a question mark (?). A list of Model 340 common commands is provided in Paragraph 9.3.

9.1.2.3 Interface and Device Specific Commands

Device Specific Commands are addressed commands. The Model 340 supports a variety of Device Specific commands to allow the user to program the controller remotely from a digital computer and to transfer measurements to the computer. Most of the Device Specific commands have a function that can also be performed from the front panel. This section discusses Common and Device Specific commands. The Device specific commands are further broken down into Interface, Display, Channel, Control Process and Curve commands for user convenience. A table of every command of each type is presented and is immediately followed by individual discussions of each command. These discussions are handled in the format described below. A list of Model 340 commands is provided in Paragraph 9.3.

9.1.3 Status Registers

There are two status registers. The Status Byte Register is described in Paragraph 9.1.3.1. The Standard Event Status Register is described in Paragraph 9.1.3.2.

9.1.3.1 Status Byte Register and Service Request Enable Register

The Status Byte Register consists of a single byte of data containing six bits of information about the condition of the Model 340.

STATUS BYTE REGISTER FORMAT

Bit –	7	6	5	4	3	2	1	0
Weighting –	128	64	32	16	8	4	2	1
Bit Name –	Ramp Done	SRQ	ESB	Error	Alarm	Settle	New OPT	New A&B

If the Service Request is enabled, any of these bits being set causes the Model 340 to pull the SRQ management low to signal the BUS CONTROLLER. These bits are reset to zero upon a serial poll of the Status Byte Register. These reports can be inhibited by turning their corresponding bits in the Service Request Enable Register to off.

The Service Request Enable Register allows the user to inhibit or enable any of the status reports in the Status Byte Register. The *SRE command is used to set the bits. If a bit in the Service Request Enable Register is set (1), then that function is enabled. Also refer to the *SRE command.

Ramp Done, Bit (7) – This bit is set when the ramp is completed.

Service Request (SRQ) Bit (6) – Determines whether the Model 340 is to report via the SRQ line and four bits determine which status reports to make. If bits 0, 1, 2, 4 or 5 are set, then the corresponding bit in the Status Byte Register is set. The Model 340 produces a service request only if bit 6 of the Service Request Enable Register is set. If disabled, the Status Byte Register can still be read by the BUS CONTROLLER by means of a serial poll (SPE) to examine the status reports, but the BUS CONTROLLER will not be interrupted by the Service Request. The *STB common command reads the Status Byte Register but will not clear the bits. It must be understood that certain bits in the Status Byte Register are continually changing.

Standard Event Status (ESB) Bit (5) – When bit 5 is set, it indicates if one of the bits from the Standard Event Status Register has been set. (Refer to Paragraph 9.1.3.2.)

Error, Bit (4) – This bit is set when there is an instrument error not related to the bus.

Alarm, Bit (3) – This bit is set when there is an alarm condition.

Settle, Bit (2) – This bit is set when the settle conditions have been reached.

New OPT, Bit (1) – New data is available from the optional inputs.

New A&B, Bit (0) – New data is available from the two normal inputs.

9.1.3.2 Standard Event Status Register and Standard Event Status Enable Register

The Standard Event Status Register supplies various conditions of the Model 340.

STANDARD EVENT STATUS REGISTER FORMAT

Bit –	7	6	5	4	3	2	1	0
Weighting –	128	64	32	16	8	4	2	1
Bit Name –	PON	Not Used	CME	EXE	DDE	QYE	Not Used	OPC

Bits 1 and 6 are not used. The user is only interrupted with the reports of this register if the bits have been enabled in the Standard Event Status Enable Register and if bit 5 of the Service Request Enable Register has been set.

The Standard Event Status Enable Register allows the user to enable any of the Standard Event Status Register reports. The Standard Event Status Enable command (*ESE) sets the Standard Event Status Enable Register bits. If a bit of this register is set, then that function is enabled. To set a bit, send the command *ESE with the bit weighting for each bit you want to be set added together. Also refer to the *ESE command discussion.

The Standard Event Status Enable Query, *ESE?, reads the Standard Event Status Enable Register. *ESR? reads the Standard Event Status Register. Once this register has been read, the bits are reset to zero.

Power On (PON) Bit (7) – This bit is set when an controller off-on-off transition has been detected.

Command Error (CME) Bit (5) – If bit 5 is set, a command error has been detected since the last reading. This means that the controller could not interpret the command due to a syntax error, an unrecognized header, unrecognized terminators, or an unsupported command.

Execution Error (EXE) Bit (4) – If bit 4, the EXE bit is set, an execution error has been detected. This occurs when the controller is instructed to do something not within its capabilities.

Device Dependent Error (DDE) Bit (3) – A device dependent error has been detected if the DDE bit is set. The actual device dependent error can be found by executing the various device dependent queries.

Query Error (QYE) Bit (2) – The QYE bit indicates a query error. It occurs rarely and involves loss of data because the output queue is full.

Operation Complete (OPC) Bit (0) – This bit is generated in response to the *OPC common command. It indicates when the Model 340 has completed all selected pending operations.

9.1.4 IEEE Interface Example Programs

Two BASIC programs are included to illustrate the IEEE-488 communication functions of the instrument. The first program was written in Visual Basic. Refer to Paragraph 9.1.4.1 for instructions on how to setup the program. The Visual Basic code is provided in Table 9-2. The second program is written in Quick Basic. Refer to Paragraph 9.1.4.3 for instructions on how to setup the program. The Quick Basic code is provided in Table 9-3. Finally, a description of operation common to both programs is provided in Paragraph 9.1.4.5. While the hardware and software required to produce and implement these programs not included with the instrument, the concepts illustrated apply to almost any application where these tools are available.

9.1.4.1 IEEE-488 Interface Board Installation for Visual Basic Program

This procedure works for Plug and Play GPIB Hardware and Software for Windows 98/95. This example uses the AT-GPIB/TNT GPIB card.

1. Install the GPIB Plug and Play Software and Hardware using National Instruments instructions.
2. Verify that the following files have been installed to the Windows System folder:
 - a. gpib-32.dll
 - b. gpib.dll
 - c. gpib32ft.dllFiles b and c support any 16-bit Windows GPIB applications being used.
3. Locate the following files and make note of their location. These files will be used during the development process of a Visual Basic program.
 - a. Niglobal.bas
 - b. Vbib-32.bas

NOTE: If the files in Steps 2 and 3 are not installed on your computer, they may be copied from your National Instruments setup disks or they may be downloaded from www.natinst.com.

4. Configure the GPIB by selecting the System icon in the Windows 98/95 Control Panel located under Settings on the Start Menu. Configure the GPIB Settings as shown in Figure 9-1. Configure the DEV12 Device Template as shown in Figure 9-2. Be sure to check the Readdress box.

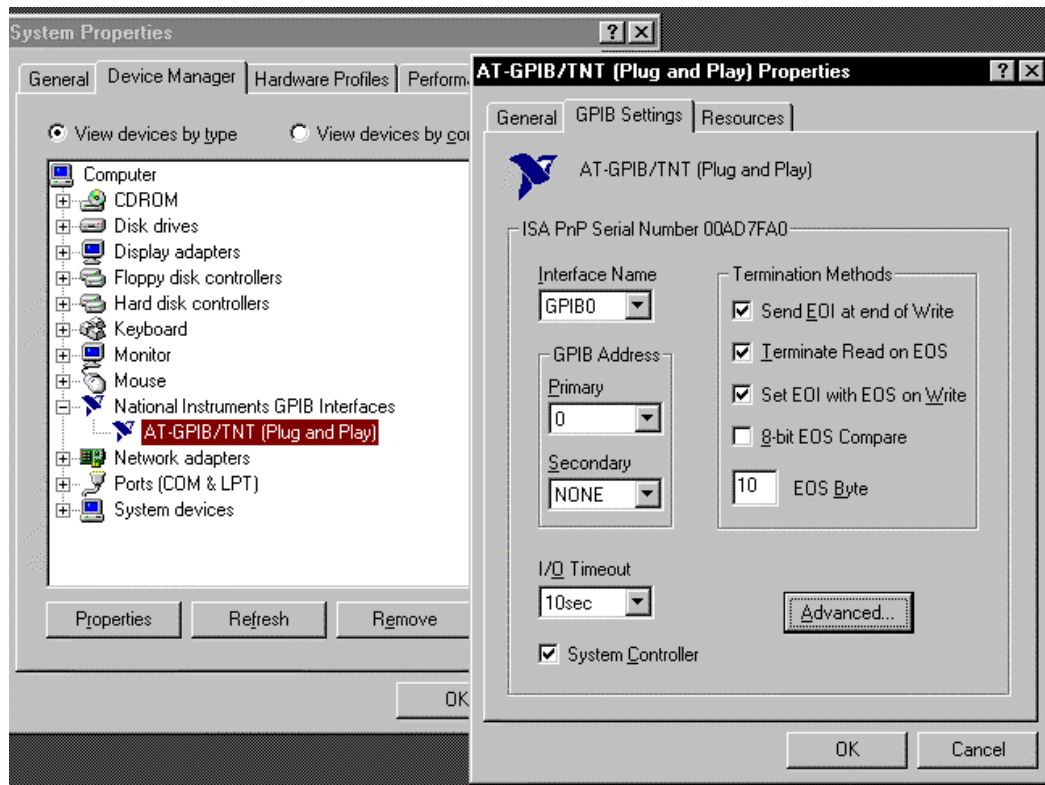

Figure 9-1. GPIB Setting Configuration

Figure 9-2. DEV 12 Device Template Configuration

9.1.4.2 Visual Basic IEEE-488 Interface Program Setup

This IEEE-488 interface program works with Visual Basic 6.0 (VB6) on an IBM PC (or compatible) with a Pentium-class processor. A Pentium 90 or higher is recommended, running Windows 95 or better. It assumes your IEEE-488 (GPIB) card is installed and operating correctly (refer to Paragraph 9.1.4.1). Use the following procedure to develop the IEEE-488 Interface Program in Visual Basic.

1. Start VB6.
2. Choose Standard EXE and select Open.
3. Resize form window to desired size.
4. On the Project Menu, select Add Module, select the Existing tab, then navigate to the location on your computer to add the following files: Niglobal.bas and Vbib-32.bas.
5. Add controls to form:
 - a. Add three Label controls to the form.
 - b. Add two TextBox controls to the form.
 - c. Add one CommandButton control to the form.
6. On the View Menu, select Properties Window.
7. In the Properties window, use the dropdown list to select between the different controls of the current project.

8. Set the properties of the controls as defined in Table 9-1.
9. Save the program.

Table 9-1. IEEE-488 Interface Program Control Properties

Current Name	Property	New Value
Label1	Name Caption	lblExitProgram Type "exit" to end program.
Label2	Name Caption	lblCommand Command
Label3	Name Caption	lblResponse Response
Text1	Name Text	txtCommand <blank>
Text2	Name Text	txtResponse <blank>
Command1	Name Caption Default	cmdSend Send True
Form1	Name Caption	frmIEEE IEEE Interface Program

10. Add code (provided in Table 9-2).
 - a. In the Code Editor window, under the Object dropdown list, select (General). Add the statement: Public gSend as Boolean
 - b. Double Click on cmdSend. Add code segment under Private Sub cmdSend_Click() as shown in Table 9-2.
 - c. In the Code Editor window, under the Object dropdown list, select Form. Make sure the Procedure dropdown list is set at Load. The Code window should have written the segment of code: Private Sub Form_Load(). Add the code to this subroutine as shown in Table 9-2.
11. Save the program.
12. Run the program. The program should resemble the following.

13. Type in a command or query in the Command box as described in Paragraph 9.1.4.5.
14. Press Enter or select the Send button with the mouse to send command.
15. Type Exit and press Enter to quit.

Table 9-2. Visual Basic IEEE-488 Interface Program

Public gSend As Boolean	'Global used for Send button state
Private Sub cmdSend_Click() gSend = True End Sub	'Routine to handle Send button press 'Set Flag to True
Private Sub Form_Load() Dim strReturn As String Dim term As String Dim strCommand As String Dim intDevice As Integer frmIEEE.Show term = Chr(13) & Chr(10) strReturn = "" Call ibdev(0, 12, 0, T10s, 1, &H140A, intDevice) Call ibconfig(intDevice, ibcREADDR,1) Do Do DoEvents Loop Until gSend = True gSend = False strCommand = frmIEEE.txtCommand.Text strReturn = "" strCommand = UCase(strCommand) If strCommand = "EXIT" Then End End If Call ibwrt(intDevice, strCommand & term) If (ibsta And EERR) Then 'do error handling if needed End If If InStr(strCommand, "?") <> 0 Then strReturn = Space(100) Call ibrd(intDevice, strReturn) If (ibsta And EERR) Then 'do error handling if needed End If If strReturn <> "" Then strReturn = RTrim(strReturn) Do While Right(strReturn, 1) = Chr(10) Or Right(strReturn, 1) = Chr(13) strReturn = Left(strReturn, Len(strReturn) - 1) Loop Else strReturn = "No Response" End If frmIEEE.txtResponse.Text = strReturn End If Loop End Sub	'Main code section 'Used to return response 'Terminators 'Data string sent to instrument 'Device number used with IEEE 'Show main window 'Terminators are <CR><LF> 'Clear return string 'Initialize the IEEE device 'Setup Repeat Addressing 'Wait loop 'Give up processor to other events 'Loop until Send button pressed 'Set Flag as False 'Get Command 'Clear response display 'Set all characters to upper case 'Get out on EXIT 'Send command to instrument 'Check for IEEE errors 'Handle errors here 'Check to see if query 'Build empty return buffer 'Read back response 'Check for IEEE errors 'Handle errors here 'Check if empty string 'Remove extra spaces and Terminators 'Send No Response 'Put response in text on main form

9.1.4.3 IEEE-488 Interface Board Installation for Quick Basic Program

This procedure works on an IBM PC (or compatible) running DOS or in a DOS window. This example uses the National Instruments GPIB-PCII/IIA card.

1. Install GPIB-PCII/IIA card using National Instruments instructions.
2. Install NI-488.2 software (for DOS). Version 2.1.1 was used for the example.
3. Verify that config.sys contains the command: device = \gpib-pc\gpib.com.
4. Reboot the computer.
5. Run IBTEST to test software configuration. Do not install the instrument before running IBTEST.
6. Run IBCONF to configure the GPIB – PCII/IIA board and dev 12. Set the EOS byte to 0AH and Enable Repeat Addressing to Yes. See Figure 9-3. IBCONF modifies gpib.com.
7. Connect the instrument to the interface board and power up the instrument. Verify the address is 12 and terminators are CR LF.

9.1.4.4 Quick Basic Program

The IEEE-488 interface program in Table 9-3 works with QuickBasic 4.0/4.5 or Qbasic on an IBM PC (or compatible) running DOS or in a DOS window. It assumes your IEEE-488 (GPIB) card is installed and operating correctly (refer to Paragraph 9.1.4.3). Use the following procedure to develop the Serial Interface Program in Quick Basic.

1. Copy c:\gpib-pc\Qbasic\qbib.obj to the QuickBasic directory (QB4).
2. Change to the QuickBasic directory and type: link /q qbib.obj,,,bqlb4x.lib; where x = 0 for QB4.0 and 5 for QB4.5 This one-time only command produces the library file qbib.qlb. The procedure is found in the National Instruments QuickBasic readme file Readme.qb.
3. Start QuickBasic. Type: qb /l qbib.qlb. Start QuickBasic in this way each time the IEEE interface is used to link in the library file.
4. Create the IEEE example interface program in QuickBasic. Enter the program exactly as presented in Table 9-3. Name the file "ieeeeexam.bas" and save.
5. Run the program.
6. Type a command query as described in Paragraph 9.1.4.5.
7. Type "EXIT" to quit the program.

National Instruments	GPIB0 Configuration	GPIB-PC2/2A Ver 2.1
Primary GPIB Address	→0	↑ Select the primary GPIB address by using the left and right arrow keys. This address is used to compute the talk and listen addresses which identify the board or device on the GPIB. Valid primary addresses range from 0 to 30 (00H to 1EH). * Adding 32 to the primary address forms the Listen Address (LA). * Adding 64 to the primary address forms the Talk Address (TA). EXAMPLE: Selecting a primary address of 10 yields the following:
Secondary GPIB Address	NONE	
Timeout setting	10sec	
Terminate Read on EOS	Yes	↓
Set EOI with EOS on Writes ..	Yes	
Type of compare on EOS	7-Bit	
EOS byte	0Ah	
Send EOI at end of Write	Yes	
System Controller	Yes	
Assert REN when SC	No	
Enable Auto Serial Polling ..	No	
Enable CIC Protocol	No	
Bus Timing	500nsec	
Parallel Poll Duration	Default	
Use this GPIB board	Yes	10 + 32 = 42 (Listen address)
Board Type	PCII	10 + 64 = 74 (Talk address)
Base I/O Address	02B8h	
F1: Help F6: Reset Value F9/Esc: Return to Map Ctl PgUp/PgDn: Next/Prev Board		

National Instruments	DEV12 Configuration	GPIB-PC2/2A Ver 2.1
Primary GPIB Address	→12	↑ Select the primary GPIB address by using the left and right arrow keys. This address is used to compute the talk and listen addresses which identify the board or device on the GPIB. Valid primary addresses range from 0 to 30 (00H to 1EH). * Adding 32 to the primary address forms the Listen Address (LA). * Adding 64 to the primary address forms the Talk Address (TA). EXAMPLE: Selecting a primary address of 10 yields the following:
Secondary GPIB Address	NONE	
Timeout setting	10sec	
Serial Poll Timeout	1sec	↓
Terminate Read on EOS	Yes	
Set EOI with EOS on Writes ..	Yes	
Type of compare on EOS	7-Bit	
EOS byte	0Ah	
Send EOI at end of Write	Yes	
Enable Repeat Addressing	Yes	
		10 + 32 = 42 (Listen address)
		10 + 64 = 74 (Talk address)
F1: Help F6: Reset Value F9/Esc: Return to Map Ctl PgUp/PgDn: Next/Prev Board		

IBCONF.EXE.eps

Figure 9-3. Typical National Instruments GPIB Configuration from IBCONF.EXE

Table 9-3. Quick Basic IEEE-488 Interface Program

```

'
' IEEEEEXAM.BAS      EXAMPLE PROGRAM FOR IEEE-488 INTERFACE
'
' This program works with QuickBasic 4.0/4.5 on an IBM PC or compatible.
'
' The example requires a properly configured National Instruments GPIB-PC2 card. The REM
' $INCLUDE statement is necessary along with a correct path to the file QBDECL.BAS.
' CONFIG.SYS must call GPIB.COM created by IBCONF.EXE prior to running Basic. There must
' be QBIB.QBL library in the QuickBasic Directory and QuickBasic must start with a link
' to it. All instrument settings are assumed to be defaults: Address 12, Terminators
' <CR> <LF> and EOI active.
'
' To use, type an instrument command or query at the prompt. The computer transmits to
' the instrument and displays any response. If no query is sent, the instrument responds
' to the last query received. Type "EXIT" to exit the program.
'
'
' REM $INCLUDE: 'c:\gpib-pc\qbasic\qbdecl.bas'      'Link to IEEE calls
' CLS                                             'Clear screen
' PRINT "IEEE-488 COMMUNICATION PROGRAM"
' PRINT
'
' CALL IBFIND("dev12", DEV12%)                   'Open communication at address 12
' TERM$ = CHR$(13) + CHR$(10)                   'Terminators are <CR><LF>
'
' LOOP2: IN$ = SPACE$(2000)                       'Clear for return string
'
' LINE INPUT "ENTER COMMAND (or EXIT):"; CMD$    'Get command from keyboard
' CMD$ = UCASE$(CMD$)                            'Change input to upper case
' IF CMD$ = "EXIT" THEN END                      'Get out on Exit
' CMD$ = CMD$ + TERM$
'
' CALL IBWRT(DEV12%, CMD$)                       'Send command to instrument
'
' CALL IBRD(DEV12%, IN$)                        'Get data back each time
'
' ENDTEST = INSTR(IN$, CHR$(13))                 'Test for returned string
' IF ENDTEST > 0 THEN                           'String is present if <CR> is seen
'   IN$ = MID$(IN$, 1, ENDTEST - 1)             'Strip off terminators
'   PRINT "RESPONSE:", IN$                     'Print return string
' ELSE
'   PRINT "NO RESPONSE"                        'No string present if timeout
' END IF
' GOTO LOOP2                                     'Get next command

```

9.1.4.5 Program Operation

Once either example program is running, try the following commands and observe the response of the instrument. Input from the user is shown in **bold** and terminators are added by the program. The word [term] indicates the required terminators included with the response.

```

ENTER COMMAND? *IDN?           Identification query. Instrument will return a string identifying itself.

RESPONSE: LSCI,MODEL340,123456,02032001 [term]
ENTER COMMAND? KRDG? A         Query Kelvin Reading for Input A. Controller returns temperature
                                reading in kelvin.

+077.350E+0
ENTER COMMAND? HTR?           Query Heater Output. Controller returns heater output in percent.

+050.0%
ENTER COMMAND? CMODE 1,1       Set Control Loop 1 to Manual PID.
ENTER COMMAND? PID? 1         Query Current PID Status. Controller returns separate PID
                                settings.

0020.0, 0010.0, 0005.0
ENTER COMMAND? PID 1,25,15,6  Set Loop 1 PID values to 25, 15, and 6.
ENTER COMMAND? BEEP 1;BEEP?  Combination command of setting the system beeper on and then
                                requesting the system beeper status.

1
ENTER COMMAND?

```

The following are additional notes on using either IEEE-488 Interface program.

- If you enter a correctly spelled query without a "?," nothing will be returned. Incorrectly spelled commands and queries are ignored. Commands and queries should have a space separating the command and associated parameters.
- Leading zeros and zeros following a decimal point are not needed in a command string, but are sent in response to a query. A leading "+" is not required but a leading "-" is required.

9.1.5 Troubleshooting

New Installation

1. Check instrument address.
2. Always send terminators.
3. Send entire message string at one time including terminators.
4. Send only one simple command at a time until communication is established.
5. Be sure to spell commands correctly and use proper syntax.
6. Attempt both 'Talk' and 'Listen' functions. If one works but not the other, the hardware connection is working, so look at syntax, terminators, and command format.
7. If only one message is received after resetting the interface, check the "repeat addressing" setting. It should be enabled.

Old Installation No Longer Working

8. Power instrument off then on again to see if it is a soft failure.
9. Power computer off then on again to see if the IEEE card is locked up.
10. Verify that the address has not been changed on the instrument during a memory reset.
11. Check all cable connections.

Intermittent Lockups

12. Check cable connections and length.
13. Increase delay between all commands to 50 ms to make sure instrument is not being over loaded.

9.2 SERIAL INTERFACE OVERVIEW

The serial interface used in the Model 340 is commonly referred to as an RS-232C interface. RS-232C is a standard of the Electronics Industries Association (EIA) that describes one of the most common interfaces between computers and electronic equipment. The RS-232C standard is quite flexible and allows many different configurations. However, any two devices claiming RS-232C compatibility cannot necessarily be plugged together without interface setup. The remainder of this paragraph briefly describes the key features of a serial interface that are supported by the instrument. A customer supplied computer with similarly configured interface port is required to enable communication.

9.2.1 Changing Baud Rate

If using the Serial Interface, the user must set the Terminator, BPS, and Parity. Press the **Interface** key to display the **COMPUTER INTERFACE** screen. The user has the option to change the Baud rate, Parity, and Terminator. Refer to Table 9-4. Use the **▲** or **▼** key make selections. Use the **Next Setting** key to advance to the next parameter. Finally, use the **Save Screen** key to accept the changes or the **Cancel Screen** key to decline the changes.

9.2.2 Physical Connection

The Model 340 has an RJ-11 connector on the rear panel for serial communication. The original RS-232C standard specifies 25 pins, but 9-pin, 25-pin, and RJ-11 connectors are commonly used in the computer industry. For you convenience, Lake Shore offers a Model 2001 RJ-11 Cable. When combined with either the Model 2002 DB-25 Adapter or Model 2003 DE-9 Adapter, this cable assembly can be used to connect the instrument to a computer with the corresponding connector type. See Figure 9-4. These adapters are described in Paragraph 10.2 and are schematically diagramed in Figures 11-8 through 11-10.

Equipment with Data Communications Equipment (DCE) wiring can be connected to the instrument with a straight through cable. However, if the interface is for Data Terminal Equipment (DTE), a Null Modem Adapter is required to exchange the transmit (Tx) and receive (Rx) lines.

The instrument uses drivers to generate the transmission voltage levels required by the RS-232C standard. These voltages are considered safe under normal operating conditions because of their relatively low voltage and current limits. The drivers are designed to work with cables up to 50 feet in length.

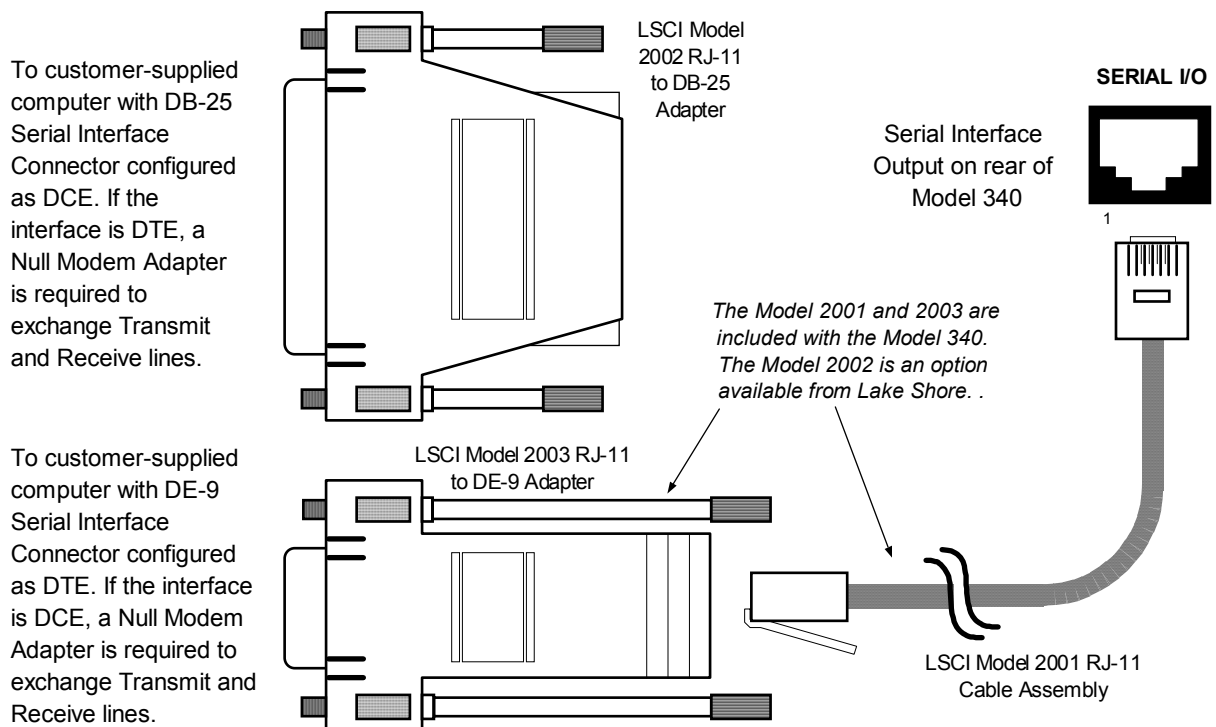

Figure 9-4. Serial Interface Connections

9.2.3 Hardware Support

The Model 340 interface hardware supports the following features. Asynchronous timing is used for the individual bit data within a character. This timing requires start and stop bits as part of each character so the transmitter and receiver can resynchronized between each character. Half duplex transmission allows the instrument to be either a transmitter or a receiver of data but not at the same time. Communication speeds of 300, 1200, 2400, 4800, 9600, 19200 Baud are supported. The Baud rate is the only interface parameter that can be changed by the user.

Hardware handshaking is not supported by the instrument. Handshaking is often used to guarantee that data message strings do not collide and that no data is transmitted before the receiver is ready. In this instrument appropriate software timing substitutes for hardware handshaking. User programs must take full responsibility for flow control and timing as described in Paragraph 9.2.6.

9.2.4 Character Format

A character is the smallest piece of information that can be transmitted by the interface. Each character is 10 bits long and contains data bits, bits for character timing and an error detection bit. The instrument uses 7 bits for data in the ASCII format. One start bit and one stop bit are necessary to synchronize consecutive characters. Parity is a method of error detection. One parity bit configured for odd parity is included in each character.

ASCII letter and number characters are used most often as character data. Punctuation characters are used as delimiters to separate different commands or pieces of data. Two special ASCII characters, carriage return (CR 0DH) and line feed (LF 0AH), are used to indicate the end of a message string.

Table 9-4. Serial Interface Specifications

Transmission: Three-Wire
Connector: RJ-11 Modular Socket
Timing Format: Asynchronous
Transmission Mode: Half Duplex
Data Interface Levels: Transmits and Receives Using EIA Voltage Levels
BPS Rate: 300, 1200, 2400, 4800, 9600, 19200
Parity: 7 Data, Odd Parity, and 1 Stop
7 Data, Even Parity, and 1 Stop
8 Data, No Parity, and 1 Stop
Terminators: CR/LF, LF/CR, CR, or LF

9.2.5 Message Strings

A message string is a group of characters assembled to perform an interface function. There are three types of message strings commands, queries and responses. The computer issues command and query strings through user programs, the instrument issues responses. Two or more command strings can be chained together in one communication but they must be separated by a semi-colon (;). Only one query is permitted per communication but it can be chained to the end of a command. The total communication string must not exceed 64 characters in length.

A command string is issued by the computer and instructs the instrument to perform a function or change a parameter setting. The format is:

<command mnemonic><space><parameter data><terminators>.

Command mnemonics and parameter data necessary for each one is described in Paragraph 9.3. Terminators must be sent with every message string.

Message Strings (Continued)

A query string is issued by the computer and instructs the instrument to send a response. The query format is:

`<query mnemonic><?><space><parameter data><terminators>.`

Query mnemonics are often the same as commands with the addition of a question mark. Parameter data is often unnecessary when sending queries. Query mnemonics and parameter data if necessary is described in Paragraph 9.3. Terminators must be sent with every message string. The computer should expect a response very soon after a query is sent.

A response string is the instruments response or answer to a query string. The instrument will respond only to the last query it receives. The response can be a reading value, status report or the present value of a parameter. Response data formats are listed along with the associated queries in Paragraph 9.3. The response is sent as soon as possible after the instrument receives the query. Typically it takes 10 ms for the instrument to begin the response. Some responses take longer.

9.2.6 Message Flow Control

It is important to remember that the user program is in charge of the serial communication at all times. The instrument can not initiate communication, determine which device should be transmitting at a given time or guarantee timing between messages. All of this is the responsibility of the user program.

When issuing commands only the user program should:

- Properly format and transmit the command including terminators as one string.
- Guarantee that no other communication is started for 50 ms after the last character is transmitted.
- Not initiate communication more than 20 times per second.

When issuing queries or queries and commands together the user program should:

- Properly format and transmit the query including terminators as one string.
- Prepare to receive a response immediately.
- Receive the entire response from the instrument including the terminators.
- Guarantee that no other communication is started during the response or for 50 ms after it completes.
- Not initiate communication more than 20 times per second.

Failure to follow these simple rules will result in inability to establish communication with the instrument or intermittent failures in communication.

9.2.7 Serial Interface Example Programs

Two BASIC programs are included to illustrate the serial communication functions of the instrument. The first program was written in Visual Basic. Refer to Paragraph 9.2.7.1 for instructions on how to setup the program. The Visual Basic code is provided in Table 9-6. The second program was written in Quick Basic. Refer to Paragraph 9.2.7.2 for instructions on how to setup the program. The Quick Basic code is provided in Table 9-7. Finally, a description of operation common to both programs is provided in Paragraph 9.2.7.3. While the hardware and software required to produce and implement these programs not included with the instrument, the concepts illustrated apply to almost any application where these tools are available.

9.2.7.1 Visual Basic Serial Interface Program Setup

The serial interface program works with Visual Basic 6.0 (VB6) on an IBM PC (or compatible) with a Pentium-class processor. A Pentium 90 or higher is recommended, running Windows 95 or better, with a serial interface. It uses the COM1 communications port at 9600 Baud. Use the following procedure to develop the Serial Interface Program in Visual Basic.

1. Start VB6.
2. Choose Standard EXE and select Open.
3. Resize form window to desired size.
4. On the Project Menu, click Components to bring up a list of additional controls available in VB6.
5. Scroll through the controls and select Microsoft Comm Control 6.0. Select OK. In the toolbar at the left of the screen, the Comm Control will have appeared as a telephone icon.
6. Select the Comm control and add it to the form.
7. Add controls to form:
 - a. Add three Label controls to the form.
 - b. Add two TextBox controls to the form.
 - c. Add one CommandButton control to the form.
 - d. Add one Timer control to the form.
8. On the View Menu, select Properties Window.
9. In the Properties window, use the dropdown list to select between the different controls of the current project.

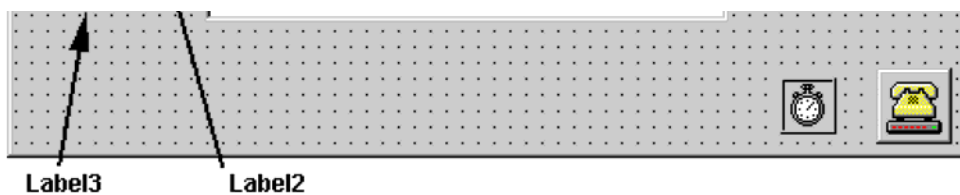
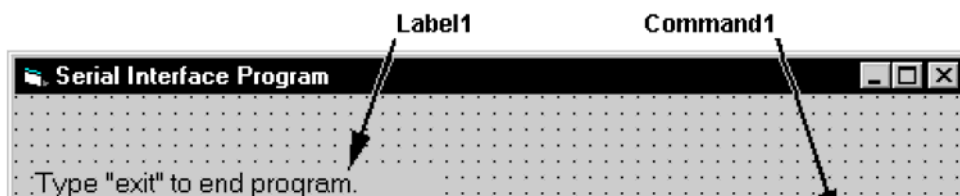

10. Set the properties of the controls as defined in Table 9-5.
11. Save the program.

Table 9-5. Serial Interface Program Control Properties

Current Name	Property	New Value
Label1	Name Caption	lblExitProgram Type "exit" to end program.
Label2	Name Caption	lblCommand Command
Label3	Name Caption	lblResponse Response
Text1	Name Text	txtCommand <blank>
Text2	Name Text	txtResponse <blank>
Command1	Name Caption Default	cmdSend Send True
Form1	Name Caption	frmSerial Serial Interface Program
Timer1	Enabled Interval	False 10

12. Add code (provided in Table 9-6).
 - a. In the Code Editor window, under the Object dropdown list, select (General). Add the statement: Public gSend as Boolean
 - b. Double Click on cmdSend. Add code segment under Private Sub cmdSend_Click() as shown in Table 9-6.
 - c. In the Code Editor window, under the Object dropdown list, select Form. Make sure the Procedure dropdown list is set at Load. The Code window should have written the segment of code: Private Sub Form_Load(). Add the code to this subroutine as shown in Table 9-6.
 - d. Double Click on the Timer control. Add code segment under Private Sub Timer1_Timer() as shown in Table 9-6.
 - e. Make adjustments to code if different Com port settings are being used.
13. Save the program.
14. Run the program. The program should resemble the following.



15. Type in a command or query in the Command box as described in Paragraph 9.2.7.3.
16. Press Enter or select the Send button with the mouse to send command.
17. Type Exit and press Enter to quit.

Table 9-6. Visual Basic Serial Interface Program

Public gSend As Boolean	'Global used for Send button state
Private Sub cmdSend_Click() gSend = True End Sub	'Routine to handle Send button press 'Set Flag to True
Private Sub Form_Load() Dim strReturn As String Dim strHold As String Dim Term As String Dim ZeroCount As Integer Dim strCommand As String frmSerial.Show Term = Chr(13) & Chr(10) ZeroCount = 0 strReturn = "" strHold = "" If frmSerial.MSComml.PortOpen = True Then frmSerial.MSComml.PortOpen = False End If frmSerial.MSComml.CommPort = 1 frmSerial.MSComml.Settings = "9600,o,7,1" frmSerial.MSComml.InputLen = 1 frmSerial.MSComml.PortOpen = True Do Do DoEvents Loop Until gSend = True gSend = False strCommand = frmSerial.txtCommand.Text strReturn = "" strCommand = UCase(strCommand) If strCommand = "EXIT" Then End End If frmSerial.MSComml.Output = strCommand & Term If InStr(strCommand, "?") <> 0 Then While (ZeroCount < 20) And (strHold <> Chr\$(10)) If frmSerial.MSComml.InBufferCount = 0 Then frmSerial.Timer1.Enabled = True Do DoEvents Loop Until frmSerial.Timer1.Enabled = False ZeroCount = ZeroCount + 1 Else ZeroCount = 0 strHold = frmSerial.MSComml.Input strReturn = strReturn + strHold End If Wend If strReturn <> "" Then strReturn = Mid(strReturn, 1, InStr(strReturn, Term) - 1) 'Strip terminators Else strReturn = "No Response" End If frmSerial.txtResponse.Text = strReturn strHold = "" ZeroCount = 0 End If Loop End Sub	'Main code section 'Used to return response 'Temporary character space 'Terminators 'Counter used for Timing out 'Data string sent to instrument 'Show main window 'Terminators are <CR><LF> 'Initialize counter 'Clear return string 'Clear holding string 'Close serial port to change settings 'Example of Comm 1 'Example of 9600 Baud,Parity,Data,Stop 'Read one character at a time 'Open port 'Wait loop 'Give up processor to other events 'Loop until Send button pressed 'Set Flag as false 'Get Command 'Clear response display 'Set all characters to upper case 'Get out on EXIT 'Send command to instrument 'Check to see if query 'Wait for response 'Add 1 to timeout if no character 'Wait for 10 millisecond timer 'Timeout at 2 seconds 'Reset timeout for each character 'Read in one character 'Add next character to string 'Get characters until terminators 'Check if string empty 'Strip terminators 'Send No Response 'Put response in textbox on main form 'Reset holding string 'Reset timeout counter
Private Sub Timer1_Timer() frmSerial.Timer1.Enabled = False End Sub	'Routine to handle Timer interrupt 'Turn off timer

9.2.7.2 Quick Basic Serial Interface Program Setup

The serial interface program listed in Table 9-7 works with QuickBasic 4.0/4.5 or Qbasic on an IBM PC (or compatible) running DOS or in a DOS window with a serial interface. It uses the COM1 communication port at 9600 Baud. Use the following procedure to develop the Serial Interface Program in Quick Basic.

1. Start the Basic program.
2. Enter the program exactly as presented in Table 9-7.
3. Adjust the Com port and Baud rate in the program as necessary.
4. Lengthen the "TIMEOUT" count if necessary.
5. Save the program.
6. Run the program.
7. Type a command query as described in Paragraph 9.2.7.3.
8. Type "EXIT" to quit the program.

Table 9-7. Quick Basic Serial Interface Program

CLS	'Clear screen
PRINT " SERIAL COMMUNICATION PROGRAM"	
PRINT	
TIMEOUT = 2000	'Read timeout (may need more)
BAUD\$ = "9600"	
TERM\$ = CHR\$(13) + CHR\$(10)	'Terminators are <CR><LF>
OPEN "COM1:" + BAUD\$ + ",0,7,1,RS" FOR RANDOM AS #1 LEN = 256	
LOOP1: LINE INPUT "ENTER COMMAND (or EXIT):"; CMD\$	'Get command from keyboard
CMD\$ = UCASE\$(CMD\$)	'Change input to upper case
IF CMD\$ = "EXIT" THEN CLOSE #1: END	'Get out on Exit
CMD\$ = CMD\$ + TERM\$	
PRINT #1, CMD\$;	'Send command to instrument
IF INSTR(CMD\$, "?") <> 0 THEN	'Test for query
RS\$ = ""	'If query, read response
N = 0	'Clr return string and count
WHILE (N < TIMEOUT) AND (INSTR(RS\$, TERM\$) = 0)	'Wait for response
IN\$ = INPUT\$(LOC(1), #1)	'Get one character at a time
IF IN\$ = "" THEN N = N + 1 ELSE N = 0	'Add 1 to timeout if no chr
RS\$ = RS\$ + IN\$	'Add next chr to string
WEND	'Get chrs until terminators
IF RS\$ <> "" THEN	'See if return string is empty
RS\$ = MID\$(RS\$, 1, (INSTR(RS\$, TERM\$) - 1))	'Strip off terminators
PRINT "RESPONSE: "; RS\$	'Print response to query
ELSE	
PRINT "NO RESPONSE"	'No response to query
END IF	
END IF	'Get next command
GOTO LOOP1	

9.2.7.3 Program Operation

Once either example program is running, try the following commands and observe the response of the instrument. Input from the user is shown in **bold** and terminators are added by the program. The word [term] indicates the required terminators included with the response.

```

ENTER COMMAND? *IDN?           Identification query. Instrument will return a string identifying itself.

RESPONSE: LSCI,MODEL340,123456,02032001 [term]
ENTER COMMAND? KRDG? A         Query Kelvin Reading for Input A. Controller returns temperature
                                reading in kelvin.

+077.350E+0
ENTER COMMAND? HTR?           Query Heater Output. Controller returns heater output in percent.

+050.0%
ENTER COMMAND? CMODE 1,1       Set Control Loop 1 to Manual PID.
ENTER COMMAND? PID? 1         Query Current PID Status. Controller returns separate PID
                                settings.

0020.0, 0010.0, 0005.0
ENTER COMMAND? PID 1,25,15,6  Set Loop 1 PID values to 25, 15, and 6.
ENTER COMMAND? BEEP 1;BEEP?  Combination command of setting the system beeper on and then
                                requesting the system beeper status.

1
ENTER COMMAND?

```

The following are additional notes on using either IEEE-488 Interface program.

- If you enter a correctly spelled query without a "?," nothing will be returned. Incorrectly spelled commands and queries are ignored. Commands and queries should have a space separating the command and associated parameters.
- Leading zeros and zeros following a decimal point are not needed in a command string, but are sent in response to a query. A leading "+" is not required but a leading "-" is required.

9.2.8 Troubleshooting

New Installation

1. Check instrument Baud rate.
2. Make sure transmit (TD) signal line from the instrument is routed to receive (RD) on the computer and vice versa. (Use a null modem adapter if not).
3. Always send terminators.
4. Send entire message string at one time including terminators (many terminal emulation programs do not).
5. Send only one simple command at a time until communication is established.
6. Be sure to spell commands correctly and use proper syntax.

Old Installation No Longer Working

7. Power instrument off then on again to see if it is a soft failure.
8. Power computer off then on again to see if communication port is locked up.
9. Verify that Baud rate has not been changed on the instrument during a memory reset.
10. Check all cable connections.

Intermittent Lockups

11. Check cable connections and length.
12. Increase delay between all commands to 100 ms to make sure instrument is not being over loaded.

9.3 IEEE-488/SERIAL INTERFACE COMMANDS

The IEEE-488/Serial Interface command list that follows is grouped by function with the most often used commands listed first. The actual list of commands is presented in alphabetical order. Parameter conventions used in the command list are as follows:

- <??? enable> A parameter with **enable** as part of the name can use these values: **0** (disabled) or **1** (enable).
- <??? status> A parameter with **status** as part of the name can use these values: **0** (off or disabled) and **1** (on or enabled).
- <??? value> A parameter with **value** as part of the name is specified in floating point format. This format can use scientific notation. Example: -2.45600E+3.
- <bit weighting> A number between 0 and 255 derived from the sum of all the weighted bit values.

<u>Bit</u>	<u>Weight</u>
0	1
1	2
2	4
3	8
4	16
5	32
6	64
7	128

- <input> Indicates which sensor input to use. Sample values are: **A**, **B**, and **A3**.
- <loop> Indicates which control loop to use. Valid values are: **1** - **2**.
- <off/on> Indicates whether an item is turned off or turned on. **0** is off and **1** is on.
- <output> Indicates which analog output to use. Valid values are: **1** - **2**.

<u>Command</u>	<u>Function</u>	<u>Page</u>	<u>Command</u>	<u>Function</u>	<u>Page</u>
Common Commands					
?	Process Last Query Received	23	SETTLE	Set Loop 1 Settle	42
*CLS	Clear Interface	23	SETTLE?	Query Loop 1 Settle	42
*ESE	Set Std. Event Status Enable	23	TUNEST?	Query Tuning Status	43
*ESE?	Query Std. Event Status Enable	23	ZONE	Set Zone	43
*ESR?	Query Std. Event Status Register	23	ZONE?	Query Zone	43
*IDN?	Query Identification	23	System Commands		
*OPC	Set Operation Complete	24	ALMRST	Reset Alarms	25
*OPC?	Query Operation Complete	24	ANALOG	Set Analog Outputs	26
*RST	Reset Instrument	24	ANALOG?	Query Analog Outputs	26
*SRE	Set Service Request Enable	24	AOUT?	Query Analog Output Data	26
*SRE?	Query Service Request Enable	24	BEEP	Set Beeper	26
*STB?	Query Status Byte	24	BEEP?	Query Beeper	26
*TST?	Query Self-Test	25	BEEPST?	Query Beeper Status	26
*WAI	Wait-To-Continue	25	BUSY?	Query Instrument Busy Status	27
Input Commands			COMM	Set Serial Interface	29
ALARM	Set Alarm	25	COMM?	Query Serial Interface	29
ALARM?	Query Alarm	25	DATETIME	Set Date and Time	31
ALARMST?	Query Alarm Status	25	DATETIME?	Query Date and Time	31
CRDG?	Query Celsius Reading	29	DFLT	Set To Factory Defaults	31
FILTER	Set Filter	33	DIOST?	Query Digital I/O Status	31
FILTER?	Query Filter	33	DISPFLD	Set Display Field	32
INCRV	Set Input Curve	33	DISPFLD?	Query Display Field	32
INCRV?	Query Input Curve	34	DISPLAY	Set Display	32
INSET	Set Input Mode	34	DISPLAY?	Query Display	32
INSET?	Query Input Mode	34	DOUT	Set Digital Output	32
INTYPE	Set Input Type	34	DOUT?	Query Digital Output	32
INTYPE?	Query Input Type	35	IEEE	Set IEEE Interface	33
KRDG?	Query Kelvin Reading	35	IEEE?	Query IEEE Interface	33
LDAT?	Query Linear Data	35	KEYST?	Query Keypad Status	35
LDATST?	Query Linear Data Status	35	LOCK	Set Lock-out and Code	36
LINEAR	Set Linear Equation	35	LOCK?	Query Lock-out and Code	36
LINEAR?	Query Linear Equation	35	MNMXRST	Reset Min/Max Data	38
MDAT?	Query Max/Min Data	38	MODE	Set Local/Remote Mode	38
MDATST?	Query Max/Min Data Status	38	MODE?	Query Local/Remote Mode	38
MNMX	Set Max/Min	38	RELAY	Set Relay	41
MNMX?	Query Max/Min	38	RELAY?	Query Relay	41
RDGST?	Query Reading Status	41	RELAYST?	Query Relay Status	41
SRDG?	Query Sensor Units Reading	43	REV?	Query Revision Information	41
Control Commands			XSCAN	Set External Scanner	43
CDISP	Set Control Portion of Display	27	XSCAN?	Query External Scanner	43
CDISP?	Query Control Portion of Display	27	Curve Commands		
CFLIT	Set Control Portion of Display	27	CRVDEL	Erase a Curve	29
CFLIT?	Query Control Portion of Display	27	CRVHDR	Set Curve Header	30
CLIMI	Set Max Current Loop 1	28	CRVHDR?	Query Curve Header	30
CLIMI?	Query Control Max Current Loop 1	28	CRVPT	Set Curve Point	30
CLIMIT	Set Control Limits	28	CRVPT?	Query Curve Point	30
CLIMIT?	Query Control Limits	28	CRVSAV	Save All Curves to Flash	30
CMODE	Set Control Mode	29	SCAL	SoftCal Voltage Entry	42
CMODE?	Query Control Mode	29	Program Commands		
CSET	Set Control Loop	31	PGM	Add a Program Line	39
CSET?	Query Control Loop	31	PGM?	Query a Program Line	39
HTR?	Query Heater Output	33	PGMDEL	Erase a Program	39
HTRST?	Query Heater Status	33	PGMMEM?	Query Program Lines Left	39
MOUT	Set Manual Output	38	PGMRUN	Run a Program	39
MOUT?	Query Manual Output	39	PGMRUN?	Query Program Status	40
PID	Set PID	40	Data Logging Commands		
PID?	Query PID	40	LOG	Turn logging on and off	36
RAMP	Set Ramp	40	LOG?	Query logging status	36
RAMP?	Query Ramp	40	LOGCNT?	Query total number of logged records	36
RAMPST?	Query Ramp Status	40	LOGPNT	Configure data point for data logging	36
RANGE	Set Heater Range	40	LOGPNT?	Query a data point for data logging	36
RANGE?	Query Heater Range	41	LOGSET	Configure data logging parameters	37
SETP	Set Setpoint	42	LOGSET?	Query data logging parameters	37
SETP?	Query Setpoint	42	LOGVIEW?	Query record of logged data	37

9.4 IEEE-488/SERIAL INTERFACE COMMANDS (Alphabetical Listing)

? Process Last Query Received
Input: ?
Returned: The response of the last query received by the instrument.
Remarks: Used for the serial interface and is not necessary for IEEE. Reprocesses the last query received by the instrument and sends a new response. This command cannot be chained with other commands and must be sent by itself.

***CLS** Clear Interface Command
Input: *CLS
Returned: Nothing
Remarks: Clears the bits in the Status Byte Register and Standard Event Status Register and terminates all pending operations. Clears the interface, but *not* the controller. The controller related command is *RST.

***ESE** Configure Status Reports in the Standard Event Status Register
Input: *ESE <bit weighting>
Returned: Nothing
Remarks: Each bit is assigned a bit weighting and represents the enable/disable status of the corresponding event flag bit in the Standard Event Status Register. To enable an event flag bit, send the command *ESE with the sum of the bit weighting for each desired bit. See the *ESR? command for a list of event flags.
Example: To enable event flags 0, 3, 4, and 7, send the command *ESE 143[term]. 143 is the sum of the bit weighting for each bit.

Bit	Bit Weighting	Event Name
0	1	OPC
3	8	DDE
4	16	EXE
7	128	PON
	143	

***ESE?** Query the Configuration of Status Reports in the Standard Event Status Register
Input: *ESE?
Returned: <ESE bit weighting>. Format: nnn[term]
Remarks: The integer returned represents the sum of the bit weighting of the enable bits in the Standard Event Status Enable Register. See the *ESR? command for a list of event flags.

***ESR?** Query Standard Event Status Register
Input: *ESR?
Returned: <ESR bit weighting>. Format: nnn[term]
Remarks: Queries for various Model 340 error conditions and status. The integer returned represents the sum of the bit weighting of the event flag bits in the Standard Event Status Register.

Bit	Bit Weighting	Event Name
0	1	OPC
2	4	QYE
3	8	DDE
4	16	EXE
5	32	CME
7	128	PON

***IDN?** Query Identification
Input: *IDN?
Returned: <manufacturer>, <model number>, <serial number>, <firmware date>
 Format: LSCI,MODEL340,aaaaaa,nnnnnn[term]
Remarks: Identifies the instrument model and software level.

***OPC** Operation Complete Command
Input: ***OPC**
Returned: Nothing
Remarks: Generates an Operation Complete event in the Standard Event Status Register upon completion of all pending selected device operations.

***OPC?** Query Operation Complete
Input: ***OPC?**
Returned: 1. Format: **n[term]**
Remarks: Places a "1" in the controller output queue upon completion of all pending selected device operations. Send this as the last command in a command string. This is *not* the same function as the ***OPC** command.

***RST** Reset Instrument
Input: ***RST**
Returned: Nothing
Remarks: Sets controller parameters to power-up settings.

***SRE** Configure Status Reports in the Service Request Enable Register
Input: ***SRE <bit weighting>**
Returned: Nothing
Remarks: Each bit has a bit weighting and represents the enable/disable status of the corresponding status flag bit in the Status Byte Register. To enable a status flag bit, send the command ***SRE** with the sum of the bit weighting for each desired bit. See the ***STB?** command for a list of status flags.
Example: To enable status flags 0, 3, 4, and 6, send the command ***SRE 89[term]**. 89 is the sum of the bit weighting for each bit.

<u>Bit</u>	<u>Bit Weighting</u>	<u>Event Name</u>
0	1	New A&B
3	8	Alarm
4	16	Error
6	64	SRQ
	89	

***SRE?** Query the Configuration of Status Reports in the Service Request Enable Register
Input: ***SRE?**
Returned: **<SRE bit weighting>**. Format: **nnn[term]**
Remarks: The integer returned represents the sum of the bit weighting of the enabled bits in the Service Request Enable Register. See the ***STB?** command for a list of status flags.

***STB?** Query Status Byte
Input: ***STB?**
Returned: **<STB bit weighting>**. Format: **nnn[term]**
Remarks: Acts like a serial poll, but does not reset the register to all zeros. The integer returned represents the sum of the bit weighting of the status flag bits that are set in the Status Byte Register.

<u>Bit</u>	<u>Bit Weighting</u>	<u>Event Name</u>
0	1	New A&B
1	2	New Option
2	4	Settle
3	8	Alarm
4	16	Error
5	32	ESB
6	64	SRQ
7	128	Ramp Done

***TST?** Query Self-Test
Input: *TST?
Returned: 0 or 1. Format: n[term]
Remarks: The Model 340 performs a self-test at power-up. 0 = no errors found, 1 = errors found.

***WAI** Wait-to-Continue
Input: *WAI
Returned: Nothing
Remarks: This command is not supported in the Model 340.

ALARM Configure Input Alarm Parameters
Input: ALARM <input>, [<off/on>], [<source>], [<high value>], [<low value>], [<latch enable>], [<relay>]
Returned: Nothing
Remarks: Configures the alarm parameters for an input.
 <input> Specifies which input to configure.
 <off/on> Determines whether the instrument checks the alarm for this input.
 <source> Specifies input data to check. Valid entries: 1 = kelvin, 2 = Celsius, 3 = sensor units, 4 = linear data.
 <high value> Sets the value the source is checked against to activate the high alarm.
 <low value> Sets the value the source is checked against to activate low alarm.
 <latch enable> Specifies a latched alarm (remains active after alarm condition correction).
 <relay enable> Specifies how the activated alarm affects relays. **NOTE:** Does not guarantee the alarm activates the relays. See the **RELAY** command.
Example: ALARM A, 0[term] - Turns off alarm checking for Input A.
 ALARM B, 1, 1, 270.0, ,1[term] - Turns on alarm checking for input B, activates high alarm if kelvin reading is over 270, and latches the alarm when kelvin reading falls below 270.

ALARM? Query Input Alarm Parameters
Input: ALARM? <input>
Returned: <off/on>, <source>, <high value>, <low value>, <latch enable>, <relay enable>
 Format: n,n,±nnn.nnnE±n,±nnn.nnnE±n,n,n[term]
Remarks: Returns the alarm parameters of an input. See the **ALARM** command for parameter descriptions. <input> specifies which input to query.

ALARMST? Query Input Alarm Status
Input: ALARMST? <input>
Returned: <high status>, <low status>. Format: n,n[term]
Remarks: Returns the alarm status of an input. <input> specifies which input to query.

ALMRST Clear Alarm Status for All Inputs
Input: ALMRST
Returned: Nothing
Remarks: Clears both the high and low status of all alarms, including latching alarms.

ANALOG Configure Analog Output Parameters
Input: **ANALOG** <output>, [<bipolar enable>], [<mode>], [<input>], [<source>], [<high value>], [<low value>], [<manual value>]
Returned: Nothing
Remarks: Configures the analog output parameters.
 <output> Specifies which analog output to configure.
 <bipolar enable> Specifies whether the analog output is positive output only or bipolar.
 <mode> Specifies data the analog output monitors. Valid entries: **0** = off, **1** = input, **2** = manual, **3** = loop. Loop is valid only if <output> = **2**.
 <input> Specifies which input to monitor if <mode> = **1**.
 <source> Specifies input data. Valid entries: **1** = kelvin, **2** = Celsius, **3** = sensor units, **4** = linear equation.
 <high value> If <mode> is **1**, this parameter represents the data at which the analog output reaches +100% output.
 <low value> If <mode> is **1**, this parameter represents the data at which the analog output reaches -100% output if bipolar, or 0% output if positive only.
 <manual value> If <mode> is **2**, this parameter is the output of the analog output.
Example: **ANALOG 1, 1, 2, , , , -25.5[term]** - Sets analog output 1 to manual mode with -25.5% output (-2.55 V).
ANALOG 2, 0, 1, A, 1, 100.0, 0.0[term] - Sets analog output 2 to monitor Input A kelvin reading with 100.0 K at +100% output (+10.0 V) and 0.0 K at 0% output (0.0 V).

ANALOG? Query Analog Output Parameters
Input: **ANALOG?** <output>
Returned: <bipolar enable>, <mode>, <input>, <source>, <high value>, <low value>, <manual value>
 Format: n,n,ann,n,±nnn.nnnE±n,±nnn.nnnE±n,±nnn.n[term]
Remarks: Returns the parameters of an analog output. See the **ANALOG** command for parameter descriptions. <output> specifies which analog output to query.

AOUT? Query Analog Output Data
Input: **AOUT?** <output>
Returned: <analog output >. Format: ±nnn.n[term]
Remarks: Returns the percentage of output of an analog output. <output> specifies which analog output data to query.

BEEP Configure System Beeper Parameters
Input: **BEEP** <off/on>
Returned: Nothing
Remarks: Enables or disables system beeper sound when an alarm condition is met. <off/on> disables/enables the beeper.

BEEP? Query System Beeper Parameters
Input: **BEEP?**
Returned: <off/on>. Format: n[term]
Remarks: Returns system beeper parameters. See the **BEEP** command for parameter descriptions.

BEEPST? Query System Beeper Status
Input: **BEEPST?**
Returned: <beeper status>. Format: n[term]
Remarks: Returns the current condition of the system beeper.

BUSY? Query Instrument Busy Status
Input: **BUSY?**
Returned: **<instrument busy status>**. Format: **n[term]**
Remarks: Indicates that the instrument is busy performing a lengthy operation like generating a SoftCal curve, writing to the Flash chip, etc. Commands that use the Instrument Busy Status say so in their description.

CDISP Configure Control Loop Display Parameters
Input: **CDISP <loop>**, [**<number of loops>**], [**<resistance>**], [**<current/power>**], [**<large output enable>**]
Returned: Nothing
Remarks: Configures control loop portion of the display.
<loop> Specifies which loop to configure.
<number of loops> Specifies how many loops to display. Valid entries: **0** = no loops, **1** = loop 1, **2** = loop 2, **3** = both loops.
<resistance> Specifies heater load resistance. Valid entries: **1** - **1000**.
<current/power> Specifies whether heater output displays in current or power. Valid entries: **1** = current, **2** = power.
<large output enable> Disables or enables the large output display.
Example: **CDISP 1, 1, 25, 0, 1[term]** - Control Loop 1 displays using 25 Ω to determine maximum power output. The output displays in current and in large numbers.

CDISP? Query Control Loop Display Parameters
Input: **CDISP? <loop>**
Returned: **<number of loops>**, **<resistance>**, **<current/power>**, **<large output enable>**
 Format: **n,nnnn,n,n[term]**
Remarks: Returns parameters for a control loop display. See the **CDISP** command for parameter descriptions. **<loop>** specifies which loop to query.

CFILT Configure Control Filter
Input: **CFILT <loop>**, [**<off/on>**]
Returned: Nothing
Remarks: Configure the control filter.
<loop> Specifies which loop to configure.
<off/on> Specifies whether the control filter is off or on.
Example: **CFILT 1, 10[term]** - The control filter on Loop 1 is turned on. The control loop filter uses the same filter window and number of filter points as the input chosen as the control channel.

CFILT? Query Control Filter
Input: **CFILT? <loop>**
Returned: **<off/on>**. Format: **n[term]**
Remarks: Returns the control filter configuration. See the **CFILT** command for parameter descriptions. **<loop>** specifies which loop to query.

CLIMI Configure Control Loop 1 Maximum Current Setting

Input: **CLIMI <max I>**

Returned: Nothing

Remarks: Sets the maximum output current for loop 1 when the Max Current Limit setting is set to "User." See **CLIMIT** command for Max Current Limit Setting. This setting is used to limit the maximum power to be delivered into a heater load. This setting is only available in main firmware version 01.03.08 and later.

<max I > Specifies the maximum current output for loop 1 when operating in the User setting for the Max Current Limit. Valid entries are from 0.1 to 2.0.

CLIMI? Query Control Loop 1 Maximum Current Setting

Input: **CLIMI?**

Returned: **<max I>**. Format: **n.nnn[term]**

Remarks: Returns the maximum output current for loop 1 when the Max Current Limit setting is set to User. See **CLIMI** command for parameter descriptions. This setting is only available in main firmware version 01.03.08 and later.

CLIMIT Configure Control Loop Limit Parameters

Input: **CLIMIT <loop>, [<SP limit value>], [<positive slope value>], [<negative slope value>], [<max current>], [<max range>]**

Returned: Nothing

Remarks: Configure control loop limits.

<loop> Specifies which loop to configure.
<SP limit value> Specifies loop setpoint limit and at what reading the loop turns off output.
<positive slope value> Specifies maximum positive change in output.
<negative slope value> Specifies maximum negative change in output.
<max current> Specifies maximum current for loop 1 heater output (Paragraph 6.12.1). Valid entries: **1** = 0.25 A, **2** = 0.5 A, **3** = 1.0 A, **4** = 2.0 A, **5** = User. ("User" setting is only available in main firmware version 01.03.08 and later.)
<max range> Specifies maximum loop 1 heater range (Paragraph 6.13.3). Valid entries: **0** - **5**.

Example: **CLIMIT 1, 325.0, 10, 0[term]** - Control Loop 1 limits the setpoint to 325, turns off output when the reading (based on the setpoint units) reaches 325, limits the change in the output to +10% with no limit on the output going down.

CLIMIT? Query Control Loop Limit Parameters

Input: **CLIMIT? <loop>**

Returned: **<SP limit value>, <positive slope value>, <negative slope value>, <max current>, <max range>**. Format: **±nnn.nnnE±n,nnn.n,nnn.n,n,n[term]**

Remarks: Returns parameters for control loop limits. See the **CLIMIT** command for parameter descriptions. **<loop>** specifies which loop to query.

CMODE	Configure Control Loop Mode
Input:	CMODE <loop>, <mode>
Returned:	Nothing
Remarks:	Configures the control mode for a control loop. <loop> Specifies which loop to configure. <mode> Specifies the control mode. Valid entries: 1 = Manual PID, 2 = Zone, 3 = Open Loop, 4 = AutoTune PID, 5 = AutoTune PI, 6 = AutoTune P.
Example:	CMODE 1, 4[term] - Control Loop 1 uses PID AutoTuning.

CMODE?	Query Control Loop Mode
Input:	CMODE? <loop>
Returned:	<mode>. Format: n[term]
Remarks:	Returns the control mode for a control loop. See the CMODE command for parameter descriptions. <loop> specifies which loop to query.

COMM	Configure Serial Interface Parameters
Input:	COMM [<terminator>], [<bps>], [<parity>]
Returned:	Nothing
Remarks:	Configures the serial interface parameters. <terminator> Specifies the terminator: 1 = <CR><LF>, 2 = <LF><CR>, 3 = <CR>, 4 = <LF>. <bps> Specifies the bits per second (bps) rate. Valid entries: 1 = 300, 2 = 1200, 3 = 2400, 4 = 4800, 5 = 9600, 6 = 19200 <parity> Specifies communication parity. Valid entries: 1 = 7 data bits, 1 stop bit, odd parity; 2 = 7 data bits, 1 stop bit, even parity; 3 = 8 data bits, 1 stop bit, no parity.
Example:	COMM 1, 6, 3[term] - After receiving the current terminator, the instrument responds at 19,200 bps using 8 data bits, 1 stop bit, no parity, and <CR><LF> as a terminator.

COMM?	Query Serial Interface Parameters
Input:	COMM?
Returned:	<terminator>, <bps>, <parity>. Format: n,n,n[term]
Remarks:	Returns the serial interface parameter. See COMM command for parameter descriptions.

CRDG?	Query Input Celsius Reading
Input:	CRDG? <input>
Returned:	<Celsius value>. Format: ±nnn.nnnE±n[term]
Remarks:	Returns the Celsius reading for an input. <input> specifies which input to query.

CRVDEL	Delete User Curve
Input:	CRVDEL <curve>
Returned:	Nothing
Remarks:	Deletes a user curve (see Paragraph 8.1.2). NOTE: Curves are not permanently updated in the curve Flash until a CRVSAV command is issued. <curve> specifies which curve to delete. Valid entries: 21 - 60 .
Example:	CRVDEL 21[term] - Deletes User Curve 21. Use CRVSAV for permanent deletion.

CRVHDR Configure Curve Header
Input: **CRVHDR <curve>, [<name>], [<SN>], [<format>], [<limit value>], [<coefficient>]**
Returned: Nothing
Remarks: Configures the user curve header (Paragraph 8.1.3). **NOTE:** Curves are not permanently updated in the curve FLASH until a **CRVSAV** command is issued.
<curve> Specifies which curve to configure. Valid entries: **21 - 60**.
<name> Specifies curve name. Limited to 15 characters.
<SN> Specifies the curve serial number. Limited to 10 characters.
<format> Specifies the curve data format. Valid entries: **1 = mV / K, 2 = V / K, 3 = Ω / K, 4 = log Ω / K, 5 = log Ω / log K.**
<limit value> Specifies the curve temperature limit in kelvin.
<coefficient> Specifies the curves temperature coefficient. Valid entries: **1 = negative, 2 = positive.**
Example: **CRVHDR 21, DT-470, 00011134, 2, 325.0, 1[term]** - Configures User Curve 21 with a name of DT-470, serial number of 00011134, data format of volts versus kelvin, upper temperature limit of 325 K, and negative coefficient.

CRVHDR? Query Curve Header
Input: **CRVHDR? <curve>**
Returned: **<name>, <SN>, <format>, <limit value>, <coefficient>**
 Format: **aaaaaaaaaaaaaaaa,aaaaaaaaa,n,nnn.nnn,n[term]**
Remarks: Returns a standard or user curve header. See the **CRVHDR** command for parameter descriptions. **<curve>** specifies which curve to query. Valid entries: **1 - 60**.

CRVPT Configure Curve Data Point
Input: **CRVPT <curve>, <index>, <units value>, <temp value>**
Returned: Nothing
Remarks: Configures a user curve data point (Paragraph 8.1.3). **NOTE:** Curves are not permanently updated in the curve Flash until a **CRVSAV** command is issued.
<curve> Specifies which curve to configure. Valid entries: **21 - 60**.
<index> Specifies the points index in the curve. Valid entries: **1 - 200**.
<units value> Specifies sensor units for this point to 6 digits.
<temp value> Specifies the corresponding temperature in kelvin for this point to 6 digits.
Example: **CRVPT 21, 2, 0.10191, 470.000[term]** – Sets User Curve 21 second data point to 0.10191 sensor units and 470.000 K.

CRVPT? Query Curve Data Point
Input: **CRVPT? <curve>, <index>**
Returned: **<units value>, <temp value>**. Format: **\pm nnn.nnnE \pm n, \pm nnn.nnnE \pm n[term]**
Remarks: Returns a standard or user curve data point. See **CRVPT** command for parameter descriptions.
<curve> Specifies which curve to query. Valid entries: **1 - 60**.
<index> Specifies the points index in the curve. Valid entries: **1 - 200**.

CRVSAV Update Curve Flash
Input: **CRVSAV**
Returned: Nothing
Remarks: Updates the Curve Flash with the current user curves. May take several seconds; use the **BUSY?** command to determine when complete.

CSET Configure Control Loop Parameters
Input: **CSET <loop>**, [**<input>**], [**<units>**], [**<off/on>**], [**<powerup enable>**]
Returned: Nothing
Remarks: Configures a control loop.
 <loop> Specifies which loop to configure.
 <input> Specifies which input to control from. Valid entries: **A** and **B**.
 <units> Specifies setpoint units. Valid entries: **1** = kelvin, **2** = Celsius, **3** = sensor units.
 <off/on> Specifies whether the control loop is on or off.
 <powerup enable> Specifies whether the control loop is on or off after power-up.
Example: **CSET 1, A, 1, 1[term]** - Control Loop 1 controls off of Input A with setpoint in kelvin.

CSET? Query Control Loop Parameters
Input: **CSET? <loop>**
Returned: **<input>**, **<units>**, **<off/on>**, **<powerup enable>**. Format: **a,n,n,n[term]**
Remarks: Returns the parameters for a control loop. See the **CSET** command for parameter descriptions. **<loop>** specifies which loop to query.

DATETIME Configure Date and Time
Input: **DATETIME [<MM>**], [**<DD>**], [**<YYYY>**], [**<HH>**], [**<mm>**], [**<SS>**], [**<sss>**]
Returned: Nothing
Remarks: Configures date and time using 24-hour format.
 <MM> Specifies month. Valid entries are: **1 - 12**.
 <DD> Specifies day. Valid entries are **1 - 31**.
 <YYYY> Specifies year. Valid entries are: **1996**.
 <HH> Specifies hour. Valid entries are: **0 - 23**.
 <mm> Specifies minutes. Valid entries are: **0 - 59**.
 <SS> Specifies seconds. Valid entries are: **0 - 59**.
 <sss> Specifies milliseconds (only updated in 10 ms increments). Valid entries: **0 - 999**.
Example: **DATETIME 2, 3, 1996, 15, 30, 0, 0[term]** - Sets date to February 3, 1996, time to 3:30pm.

DATETIME? Query Date and Time
Input: **DATETIME?**
Returned: **<MM>**, **<DD>**, **<YYYY>**, **<HH>**, **<mm>**, **<SS>**, **<sss>**.
 Format: **nn,nn,nnnn,nn,nn,nn,nnn[term]**
Remarks: Returns date and time. See the **DATETIME** command for parameter descriptions.

DFLT Set To Factory Defaults
Input: **DFLT 99**
Returned: Nothing
Remarks: Sets all configuration values to factory defaults and resets the instrument. The **99** is required to prevent accidentally setting the unit to defaults. May take some time; use the **BUSY?** command to determine completion.

DIOST? Query Digital Input/Output Status
Input: **DIOST?**
Returned: **<input bit weighting>**, **<output bit weighting>**. Format: **nnn,nnn[term]**
Remarks: Returns the status of the digital input and output in bit weighting format.

DISPFLD Configure Displayed Field
Input: **DISPFLD** <field>, [<input>], [<source>]
Returned: Nothing
Remarks: Configures the displayed field.
 <field> Specifies field to configure. Valid entries: **1 - 8**.
 <input> Specifies input to display in the field.
 < source> Specifies input data to display. Valid entries: **1** = kelvin, **2** = Celsius, **3** = sensor units, **4** = linear data, **5** = minimum data, and **6** = maximum data.
Example: **DISPFLD 2, A, 1[term]** - Displays kelvin reading for Input A in display field 2.

DISPFLD? Query Displayed Field
Input: **DISPFLD?** <field>
Returned: <input>, <data source>. Format: **ann,n[term]**
Remarks: Returns the parameters for a displayed field. See the **DISPFLD** command for parameter descriptions. <field> specifies which field to query. Valid entries: **1 - 8**.

DISPLAY Configure Main Display Parameters
Input: **DISPLAY** [<number of fields>], [<contrast>], [<backlight enable>]
Returned: Nothing
Remarks: Configures the main display screen.
 <number of fields> Specifies how many input fields to display.
 <contrast> Specifies the display contrast percentage.
 <backlight enable> Disables or enables the display backlight.
Example: **DISPLAY 3, 60[term]** - Displays 3 input fields and sets the contrast to 60%.

DISPLAY? Query Main Display Parameters
Input: **DISPLAY?**
Returned: <number of fields>, <contrast>, <backlight enable>. Format: **n,nnn,n[term]**
Remarks: Returns main display parameters. See the **DISPLAY** command for parameter descriptions.

DOUT Configure Digital Output Parameters
Input: **DOUT** [<mode>], [<bit weighting>]
Returned: Nothing
Remarks: Configures the parameters of the digital output.
 <mode> Specifies the mode of the digital output. Valid entries: **0** = off, **1** = alarms, **2** = scanner, and **3** = manual.
 <bit weighting> Specifies the manual digital output settings if <mode> is **3**.
Example: **DOUT 3, 21[term]** - Manually sets digital output lines D1, D3, and D5 to logic high, and D2 and D4 to logic low.

DOUT? Query Digital Output Parameters
Input: **DOUT?**
Returned: <mode>, <bit weighting>. Format: **n,nnn[term]**
Remarks: Returns the digital output parameters. See the **DOUT** command for parameter descriptions.

FILTER	Configure Input Filter Parameters
Input:	FILTER <input>, [<off/on >], [<points>], [<window>]
Returned:	Nothing
Remarks:	Configures input filtering function. <input> Specifies input to configure. <off/on> Specifies whether the filter function is off or on. <points> Specifies how many data points the filtering function uses. <window> Specifies what percent of full scale reading limits the filtering function. Reading changes greater than this percentage reset the filter.
Example:	FILTER B, 10, 2[term] - Filter input B data through 10 readings with 2% of full scale window.

FILTER?	Query Input Filter Parameters
Input:	FILTER? <input>
Returned:	<off/on >, <points>, <window> . Format: a,nn,nn[term]
Remarks:	Returns input filter configuration. See the FILTER command for parameter descriptions. <input> specifies which input to query.

HTR?	Query Heater Output
Input:	HTR?
Returned:	<heater value> . Format: nnn.n[term]
Remarks:	Returns the heater output in percent.

HTRST?	Query Heater Status
Input:	HTRST?
Returned:	<error code> . Format: nn[term]
Remarks:	Returns the heater error code (Paragraph 11.8).

IEEE	Configure IEEE-488 Interface Parameters
Input:	IEEE [<terminator>], [<EOI enable>], [<address>]
Returned:	Nothing
Remarks:	Configures parameters of the IEEE interface. <terminator> Specifies the terminator. Valid entries: 0 = no terminator, 1 = <CR><LF>, 2 = <LF><CR>, 3 = <CR>, 4 = <LF>. <EOI enable> Disables/enables the EOI mode. <address> Specifies the IEEE address.
Example:	IEEE 1, 1, 4[term] - After receipt of the current terminator, the instrument responds to address 4, uses <CR><LF> as the new terminator and uses EOI mode.

IEEE?	Query IEEE-488 Interface Parameters
Input:	IEEE?
Returned:	<terminator>, <EOI enable>, <address> . Format: n,n,nn[term]
Remarks:	Returns the IEEE interface parameters. See the IEEE command for parameter descriptions.

INCRV	Configure Input Curve Number
Input:	INCRV <input>, <curve number>
Returned:	Nothing
Remarks:	Specifies the curve an input uses for temperature conversion. <input> Specifies which input to configure. <curve number> Specifies which curve the input uses. If specified curve parameters do not match the input, the curve number defaults to 0. Valid entries: 0 = none, 1 - 20 = standard curves, 21 - 60 = user curves.
Example:	INCRV A, 23[term] - Input A uses User Curve 23 for temperature conversion.

INCRV? Query Input Curve Number
Input: **INCRV? <input>**
Returned: **<curve number>**. Format: **nn[term]**
Remarks: Returns the input curve number. See the **INCRV** command for parameter descriptions.
<input> Specifies which input to query.

INSET Configure Hardware Input Setup Parameters
Input: **INSET <input>, [<enable>], [<compensation>]**
Returned: Nothing
Remarks: Configures hardware input setup parameters.
<input> Specifies input to configure.
<enable> Specifies whether the input is allowed to be read.
<compensation> Specifies whether to use compensation for this input. Valid entries: **0** = off, **1** = on, **2** = pause. Field is only valid with NTC resistor or special.
Example: **INSET A, , 1[term]** - Turns on compensation for Input A.

INSET? Query Input Hardware Setup Parameters
Input: **INSET? <input>**
Returned: **<enable>, <compensation>**. Format: **n,n[term]**
Remarks: Returns input hardware setup parameters. See the **INSET** command for parameter descriptions. **<input>** specifies which input to query.

INTYPE Configure Input Type Parameters
Input: **INTYPE <input>, [<type>], [<units>], [<coefficient>], [<excitation>], [<range>]**
Returned: Nothing
Remarks: Configures input type parameters.
<input> Specifies input to configure.
<type> Specifies input sensor type (Paragraph 5.1.1). Valid entries:

0 = Special	5 = Platinum 1000	10 = Germanium
1 = Silicon Diode	6 = Rhodium Iron	11 = Capacitor
2 = GaAlAs Diode	7 = Carbon-Glass	12 = Thermocouple
3 = Platinum 100 (250Ω)	8 = Cernox	
4 = Platinum 100 (500Ω)	9 = RuOx	

<units> Specifies input sensor units. It is a predetermined value based on **<type>**. If it is supplied, **<type>** = **0** (Special). Valid entries: **1** = volts, **2** = ohms.
<coefficient> Specifies input coefficient. It is a predetermined value based on **<type>**. If it is supplied, **<type>** = **0** (Special). Valid entries: **1** = negative, **2** = positive.
<excitation> Specifies input excitation (Paragraph 5.1.4). It is a predetermined value based on **<type>**. If it is supplied, **<type>** = **0** (Special). Valid entries:

0 - Off	3 - 300 nA	6 - 10 μA	9 - 300 μA	12 - 1 mV
1 - 30 nA	4 - 1 μA	7 - 30 μA	10 - 1 mA	
2 - 100 nA	5 - 3 μA	8 - 100 μA	11 - 10 mV	

<range> Specifies the input range (refer to Paragraph 5.1.4). This parameter has a predetermined value based on **<type>**. If this parameter is supplied, **<type>** changes to **0** (Special). Valid entries are (given in volts):

1 - 1 mV	4 - 10 mV	7 - 100 mV	10 - 1 V	13 - 7.5 V
2 - 2.5 mV	5 - 25 mV	8 - 250 mV	11 - 2.5 V	
3 - 5 mV	6 - 50 mV	9 - 500 mV	12 - 5 V	

Example: **INTYPE A, 2[term]** - Sets Input A sensor type to GaAlAs diode.
INTYPE B, 3, , 7[term] - Sets Input B sensor type to Platinum 100, but use a 30 μV excitation. Input B now responds as a Special.

INTYPE? Query Input Type Parameters
Input: **INTYPE? <input>**
Returned: **<type>, <units>, <coefficient>, <excitation>, <range>**. Format: **n,n,n,nn,nn[term]**
Remarks: Returns input type parameters. See the **INTYPE** command for parameter descriptions.
<input> Specifies which input to query.

KEYST? Query Keypad Status
Input: **KEYST?**
Returned: **<keypad status>**. Format: **n[term]**
Remarks: Returns keypad status since the last **KEYST?**. **1** = key pressed, **0** = no key pressed.
KEYST? returns **1** after initial power-up.

KRDG? Query Kelvin Reading for an Input
Input: **KRDG? <input>**
Returned: **<kelvin value>**. Format: **±nnn.nnnE±n[term]**
Remarks: Returns the kelvin reading for an input. **<input>** specifies which input to query.

LDAT? Query Linear Equation Data for an Input
Input: **LDAT? <input>**
Returned: **<linear value>**. Format: **±nnn.nnnE±n[term]**
Remarks: Returns the linear equation data for an input. **<input>** specifies which input to query.

LDATST? Query Linear Equation Data Status for an Input
Input: **LDATST? <input>**
Returned: A bit weighted integer from 0 - 255. Format: **nnn[term]**
Remarks: The integer returned represents the sum of the bit weighting of the input linear equation data status flag bits. **<input>** specifies which input to query. See **RDGST?** Command.

LINEAR Configure Input Linear Equation Parameters
Input: **LINEAR <input>, [<equation >], [<varM value>], [<X source>], [<B source>], [<varB value>]**
Returned: Nothing
Remarks: Configures the linear equation for an input.
<input> Specifies input to configure.
<equation> Specifies linear equation to use.
 Valid entries: **1** = (y = mx + b), **2** = (y = m(x + b)).
<varM value> Specifies a value for m in the equation.
<X source > Specifies input data to use. Valid entries: **1** = kelvin, **2** = Celsius, **3** = sensor units.
<B source > Specifies what to use for b in the equation. To use a setpoint, set its units to the same type specified in **<X source>**. Valid entries: **1** = a value, **2** = +SP1, **3** = -SP1, **4** = +SP2, **5** = -SP2.
<varB value> Specifies a value for b in the equation if **<B source>** is 1.
Example: **LINEAR A, 1, 1.0, 1, 3[term]** - The linear data for Input A is calculated from the kelvin reading of the input using the equation: $y = 1.0 * x - SP1$.

LINEAR? Query Input Linear Equation Parameters
Input: **LINEAR? <input>**
Returned: **<equation>, <varM value>, <X source>, <B source>, <varB value>**
 Format: **n,±nnn.nnn,n,n,±nnn.nnn[term]**
Remarks: Returns input linear equation configuration. See the **LINEAR** command for parameter descriptions. **<input>** specifies which input to query.

LOCK	Configure Lock-out and Lock-out Code Input: LOCK [<off/on>, [<code>] Returned: Nothing Remarks: Configures keypad lock-out and lock-out code. <off/on> Disables/enables the keypad lock-out. <code> Specifies lock-out code. Valid entries: 000 - 999 . Example: LOCK 1, 123[term] - Enables keypad lock-out and sets the code to 123.
LOCK?	Query Lock-out and Lock-out Code Input: LOCK? Returned: <off/on>, <code>. Format: n,nnn[term] Remarks: Returns lock-out status and lock-out code. See the LOCK command for parameter descriptions.
LOG	Data Logging On/Off Input: LOG <stop/start> Returned: Nothing Remarks: Turns data logging on and off. <stop/start> 0 = stop, 1 = start.
LOG?	Query Data Logging Status Input: LOG? Returned: <off/on>. Format: n[term] Remarks: Returns data logging status: 0 = stopped, 1 = logging in progress.
LOGCNT?	Query Total Number of Logged Records. Input: LOGCNT? Returned: <# of logged records>. Format: n[term] Remarks: Returns total number of logged records.
LOGPNT	Configure a data point for data logging Input: LOGPNT <point>,<point type>[,<input>,<source>] Returned: Nothing Remarks: Configures a data point for data logging. <point> Specifies which point to configure. Valid entries: 1 - 4 . <point type> Specifies the data type. Valid entries: 0 = None, 1 = Input, 2 = SP1, 3 = SP2, 4 = Out1, 5 = Out2. <input> Specifies input when <type> = 1 . <source> Specifies input data to log when <type> = 1 . Valid entries: 1 = Kelvin, 2 = Celsius, 3 = sensor units, 4 = linear data, 5 = min. data, 6 = max. data.
LOGPNT?	Query a data point for data logging Input: LOGPNT? <point> Returned: <point type>[,<input>,<source>]. Format: n,a,n[term] Remarks: Returns the specified data point setting for data logging. See the LOGPNT command for parameter descriptions. <point> Specifies which point to query. Valid entries: 1 - 4 .

LOGSET Configure data logging parameters
Input: **LOGSET** <log type>,<interval>,<overwrite>,<start mode>
Returned: Nothing
Remarks: Configures data logging parameters.
 <log type> Specifies readings/seconds. Valid entries: **1** = readings, **2** = seconds.
 <interval> Specifies number of readings between each record when <log type> = 1.
 Specifies number of seconds between each record when <log type> = 2.
 Valid entries: **1 – 3600**.
 <overwrite> Specifies whether overwrite enable. Valid entries: **0** = No, **1** = Yes.
 <start mode> Specifies start mode. Valid entries: **0** = clear, **1** = continue.

LOGSET? Query data logging parameters
Input: **LOGSET?**
Returned: <log type>,<interval>,<overwrite>,<start mode>.
 Format: n,n,n,n[term]
Remarks: Returns the data logging parameters. If there is no valid SRAM Data card mounted, the Model 340 returns 0,0,0,0. See LOGSET command for parameter descriptions.

LOGVIEW? Query record of logged data
Input: **LOGVIEW?** <record>,<point>
Returned: <timestamp>,<point data>. The format of <point data> varies depending on the point type specified by point. See DATETIME? command for the <timestamp> parameters format.

(1) point type = Input <reading>,<status>
 <reading> Input reading in [K], [C], or sensor units.
 <status> Shows status of the input in decimal. Possible maximum value is 255. Each bit has its own meaning if set to 1.
 Bit 7: .DISABLED.
 Bit 6: .NOCURVE.
 Bit 5: .S-OVER.
 Bit 4: .S-ZERO.
 Bit 3: .T-OVER.
 Bit 2: .T-UNDER.
 Bit 1: Old reading.
 Bit 0: Invalid reading.

(2) point type = SP1/2 <value>
 <value> SP1/2 value in [K], [C], or sensor units.

(3) point type = Out2 <value>
 <value> Out2 value in [%]

(4) point type = Out1 <value>,<pow/cur>,<heater range>
 <value> Out1 value in [%]
 <pow/cur> 1 = current, 2 = power
 <heater range> Heater range in [W]. 0.0 when heater is OFF

(5) point type = None 0.0

If there is no valid SRAM Data card mounted or data logging is in progress, the Model 340 returns 0,0,0,0,0,0,0.

Remarks: Returns the record of the specified point of the specified record number.
 <record> Specifies logged data record number. Valid entries: **1** – value returned by LOGCNT?
 <point> Specifies point number to be returned. Valid entries: **1 – 4**.

MDAT? Query Min/Max Data for an Input
Input: **MDAT? <input>**
Returned: <min value>, <max value>. Format: $\pm nnn.nnnE\pm n, \pm nnn.nnnE\pm n$ [term]
Remarks: Returns the minimum and maximum input data. <input> specifies which input to query.

MDATST? Query Min/Max Data Status for an Input
Input: **MDATST? <input>**
Returned: <min bit weighting>, <max bit weighting>. Format: **nnn,nnn**[term]
Remarks: The integer returned represents the sum of the bit weighting of the input minimum /maximum data status flag bits. <input> specifies which input to query. See **RDGST?** Command.

MNMX Configure Minimum and Maximum Input Function Parameters
Input: **MNMX <input>, [<on/pause>], [<source>]**
Returned: Nothing
Remarks: Configures the minimum and maximum input functions.
 <input> Specifies input to configure.
 <on/pause> Turns on or Pauses the max/min function. Valid entries: **1** = on, **2** = paused.
 <source> Specifies input data to process through max/min. Valid entries: **1** = kelvin, **2** = Celsius, **3** = sensor units, **4** = linear data.
Example: **MNMX B, 1, 3**[term] - Input B min/max function is on and processes data from the input sensor units reading.

MNMX? Query Minimum and Maximum Input Function Parameters
Input: **MNMX? <input>**
Returned: <on/pause>, <source>. Format: **n,n**[term]
Remarks: Returns a min/max input configuration. See the **MNMX** command for parameter descriptions. <input> specifies which input to query.

MNMXRST Resets Min/Max Function for All Inputs
Input: **MNMXRST**
Returned: Nothing
Remarks: Resets the minimum and maximum data for all inputs.

MODE Configure Remote Interface Mode
Input: **MODE <mode>**
Returned: Nothing
Remarks: Configures the remote interface mode. <mode> specifies which mode to operate. Valid entries: **1** = local, **2** = remote, **3** = remote with local lockout.
Example: **MODE 2**[term] - Places the Model 340 into remote mode.

MODE? Query Remote Interface Mode
Input: **MODE?**
Returned: <mode>. Format: **n**[term]
Remarks: Returns the remote interface mode. See the **MODE** command for parameter descriptions.

MOUT Configure Control Loop Manual Output Value
Input: **MOUT <loop>, <value>**
Returned: Nothing
Remarks: Configures the control loop manual output values. <loop> specifies loop to configure. <value> specifies value for manual output.
Example: **MOUT 1, 22.45**[term] - Control Loop 1 manual output is 22.45%.

MOUT? Query Control Loop Manual Output Values**Input:** **MOUT?** <loop>**Returned:** <manual output value>. Format: ±nnn.nn[term]**Remarks:** Returns the control loop manual output value. <loop> specifies which loop to query.

PGM Add A Program Line**Input:** **PGM** <program>, <command>, [<param1>], [<param2>],...**Returned:** Nothing**Remarks:** Adds a command to a program. The command appends to the end of the specified program. Each command has a different number of parameters and parameter formats. The parameters are detailed under each command (Paragraph 8.3). <command> specifies the command. End commands are ignored. Valid entries are:**0** - End: no parameters**1** - NOP: no parameters**2** - Repeat: [**<iterations>**], [**<infinite loop enable>**]**3** - End Repeat: no parameters**4** - Wait: [**<hours>**], [**<minutes>**], [**<seconds>**]**5** - Call: [**<program>**]**6** - Ramp MOut Abs.: [**<MOut value>**], [**<hours>**], [**<minutes>**], [**<seconds>**], [**<rate value>**]**7** - Ramp MOut Rel.: [**<deviation value>**], [**<hours>**], [**<minutes>**], [**<seconds>**], [**<rate>**]**8** - Ramp SP Abs.: [**<SP value>**], [**<hours>**], [**<minutes>**], [**<seconds>**], [**<rate>**]**9** - Ramp SP Rel.: [**<deviation value>**], [**<hours>**], [**<minutes>**], [**<seconds>**], [**<rate>**]**10** - Parameters: [**<control channel>**], [**<control mode>**], [**<P value>**], [**<I value>**], [**<D value>**], [**<heater range>**]**11** - Digital Output: [**<bit weighting>**]**12** - Relays: [**<high enable>**], [**<low enable>**]**13** - Settle: [**<hours>**], [**<minutes>**], [**<seconds>**], [**<band>**]**Example:** **PGM 1, 5, 2[term]** - Appends a Call command that calls program 2 to the end of program 1.

PGM? Query A Program Line**Input:** **PGM?** <program>, <line>**Returned:** Variable. Format: variable**Remarks:** Returns the command and parameters for the specified program and line number. See the **PGM** command and Paragraph 8.3. Querying past the end of a program returns an End command.

PGMDEL Erase A Program**Input:** **PGMDEL** <program>**Returned:** Nothing**Remarks:** Erases a program. <program> specifies the program to erase. Valid entries: **1 - 10**.**Example:** **PGMDEL 2[term]** - Erases program 2.

PGMMEM? Query Number of Program Lines Remaining**Input:** **PGMMEM?****Returned:** <lines>. Format: nnn[term]**Remarks:** Returns the number of programs lines remaining in program memory.

PGMRUN Run a Program.**Input:** **PGMRUN** <program>**Returned:** Nothing**Remarks:** Runs or terminates a program.<program> Specifies the program to run. Valid entries: **0** = terminate current program, **1 - 10**.**Example:** **PGMRUN 1[term]** - Begins execution of program 1.

RANGE? Query Heater Range
Input: **RANGE?**
Returned: <range>. Format: n[term]
Remarks: Returns the heater range. See the **RANGE** command for parameter descriptions.

RDGST? Query Input Status
Input: **RDGST? <input>**
Returned: <reading bit weighting>. Format: nnn[term].
Remarks: The integer returned represents the sum of the bit weighting of the input status flag bits. <input> specifies which input to query.

<u>Bit</u>	<u>Bit Weighting</u>	<u>Status Indicator</u>
0	1	invalid reading
1	2	old reading
4	16	temp underrange
5	32	temp overrange
6	64	units zero
7	128	units overrange

RELAY Configure Relay Control Parameters
Input: **RELAY <high/low>, [<mode>], [<off/on>]**
Returned: Nothing
Remarks: Configures relay control.
 <high/low> Specifies which relay to configure. Valid entries: **1** (high) and **2** (low).
 <mode> Specifies relay settings mode. Valid entries: **0** = off, **1** = alarms, **2** = manual.
 <off/on> Specifies the manual relay settings if <mode> = **2**.
Example: **RELAY 1, 2, 1[term]** - Manually turns on the high relay.

RELAY? Query Relay Control Parameters
Input: **RELAY? <high/low>**
Returned: <mode>, <off/on>. Format: n,n[term]
Remarks: Returns relay control. See the **RELAY** command for parameter descriptions. <high/low> specifies which relay to query. Valid entries: **1** = high and **2** = low.

RELAYST? Query Relay Status
Input: **RELAYST? <high/low>**
Returned: <status>. Format: n[term]
Remarks: Returns specified relay status.: **0** = off, **1** = on. <high/low> specifies which relay status to query. Valid entries: **1** = high, **2** = low.

REV? Query Revision Information
Input: **REV?**
Returned: <master rev date>,<master rev number>,<master serial number>,<switch setting SW1>,<input rev date>,<input rev number>, <option ID>,<option rev date>,<option rev number>
 Format: nnnnnn,nn.nn.nn,nnnnnn,nnn,nnnnnn,nn.nn.nn,nnnn,nnnnnn,nn.nn.nn[term]
Remarks: Returns instrument revision information.

SCAL Generate SoftCal™ Curve

Input: **SCAL <std>, <dest>, <SN>, <T1 value>, <U1 value>, <T2 value>, <U2 value>, [<T3 value>], [<U3 value>]**

Returned: Nothing

Remarks: Generates a SoftCal curve (Paragraph 8.2). **NOTE:** Curves are not permanently updated in the curve Flash until a **CRVSAV** command is issued. May take some time, use the **BUSY?** command to determine completion.

<std> Specifies the standard curve to generate a SoftCal from. Valid entries: **1 - 20**.

<dest> Specifies the user curve to store the SoftCal curve. Valid entries: **21 - 60**.

<SN> Specifies the curve serial number. Limited to 10 characters.

<T1 value> Specifies first temperature point.

<U1 value> Specifies first sensor units point.

<T2 value> Specifies second temperature point.

<U2 value> Specifies second sensor units point.

<T3 value> Specifies third temperature point.

<U3 value> Specifies third sensor units point.

Example: **SCAL 1, 21, 340000, 4.2, 1.6260, 77.32, 1.0205, 300.0, 0.5189[term]** - Generates a three-point SoftCal curve from standard curve 1 and saves it in user curve 21.

SETP Configure Control Loop Setpoint

Input: **SETP <loop>, <value>**

Returned: Nothing

Remarks: Configures the control loop setpoint.

<loop> Specifies which loop to configure.

<value> The value for the setpoint (in whatever units the setpoint is using).

Example: **SETP 1, 122.5[term]** - Control Loop 1 setpoint is now 122.5 (based on its units).

SETP? Query Control Loop Setpoint

Input: **SETP? <loop>**

Returned: **<value>**. Format: **±nnn.nnnE±n[term]**

Remarks: Returns the control loop setpoint. See the **SETP** command for parameter descriptions. **<loop>** specifies which loop to query.

SETTLE Sets Loop1 Settle Parameters

Input: **SETTLE [<threshold>], [<time>]**

Returned: Nothing

Remarks: Configures Loop 1 settle parameters. (Refer to description of Status Byte Register in Paragraph 9.1.3.1).

<threshold> Specifies the allowable band around the setpoint. Valid entries: **0.0 - 100.00**.

<time> Specifies time in seconds the reading must stay within the band. Valid entries: **0 - 86400**.

Example: **SETTLE 10.0, 10[term]** - The Control Loop 1 input readings must be within ±10 K of the setpoint for 10 seconds before the Within Control Limit flag is set.

SETTLE? Query Loop1 Settle Parameters

Input: **SETTLE?**

Returned: **<threshold>, <time>**. Format: **nnn.nn,nnnnn[term]**

Remarks: Returns Control Loop 1 settle parameters. See the **SETTLE** command for parameter descriptions.

SRDG? Query Sensor Units Reading for an Input
Input: **SRDG? <input>**
Returned: **<sensor units value>**. Format: **±nnn.nnnE±n[term]**
Remarks: Returns the sensor units reading for an input. **<input>** Specifies which input to query.

TUNEST? Query Control Loop 1 Tuning Status
Input: **TUNEST?**
Returned: **<tuning status>**. Format: **n[term]**
Remarks: Returns **0** if the loop is not tuning, and **1** if it is tuning.

XSCAN Configure External Scanner Mode Parameters
Input: **XSCAN [<mode>], [<channel>], [<interval>]**
Returned: Nothing
Remarks: Configures the external scanner mode (refer to Paragraph 5.4).
<mode> Specifies scan mode. Valid entries: **0** = off, **1** = manual, **2** = autoscan, **3** = slave.
<channel> Specifies scanned input to use if **<mode>** = manual. Valid entries: **1 - 16**.
<interval> Specifies autoscan interval in seconds if **<mode>** = autoscan. Valid entries: **0 - 999**.
Example: **XSCAN 2,,5[term]** - Sets the instrument to autoscan the inputs with an interval of 5 seconds.

XSCAN? Query External Scanner Mode Parameters
Input: **XSCAN?**
Returned: **<mode>, <channel>, <interval>**. Format: **n,nn,nnn[term]**
Remarks: Returns the external scanner mode configuration. See the **XSCAN** command for parameter descriptions.

ZONE Configure Control Loop Zone Table Parameters
Input: **ZONE <loop>, <zone>, [<top value>], [<P value>], [<I value>], [<D value>], [<mout value>], [<range>]**
Returned: Nothing
Remarks: Configures the control loop limit band parameters used in conjunction with the Status Byte Register (refer to Paragraph 9.1.3).
<loop> Specifies which loop to configure.
<zone> Specifies which zone in the table to configure. Valid entries are: **1 - 10**.
<top value> Specifies the top temperature of this zone.
<P value> Specifies the P for this zone.
<I value> Specifies the I for this zone.
<D value> Specifies the D for this zone.
<mout value> Specifies the manual output for this zone.
<range> Specifies the heater range for this zone if **<loop>** = **1**. Valid entries: **0 - 5**.
Example: **ZONE 1, 1, 25.0, 10, 20, 0, , 2[term]** - Control Loop 1 zone 1 is valid to 25.0 K with a P of 10, an I of 20, no D, and a heater range of 2.

ZONE? Query Control Loop Zone Table Parameters
Input: **ZONE? <loop>, <zone>**
Returned: **<top value>, <P value>, <I value>, <D value>, <mout value>, <range>**
 Format: **nnn.nnn,nnnn.n,nnnn.n,nnnn,±nnn.nn,n[term]**
Remarks: Returns control loop zone table parameters. See the **ZONE** command for parameter descriptions.
<loop> Specifies which loop to query.
<zone> Specifies which zone in the table to query. Valid entries: **1 - 10**.

This Page Intentionally Left Blank

CHAPTER 10

OPTIONS AND ACCESSORIES

10.0 GENERAL

This chapter lists Model 340 Temperature Controller Options in Paragraph 10.1 and Accessories in Paragraph 10.2. Further installation details of the Model 3462 Dual Standard Input Option Card are provided in Paragraph 10.3, the Model 3464 Dual Thermocouple Input Option Card in Paragraph 10.4, the Model 3465 Single Capacitance Input Option Card in Paragraph 10.5, and the Model 3468 Eight-Channel Input Option Card in Paragraph 10.6.

10.1 OPTIONS

Model	Description Of Model 340 Options
3462	<p>Dual Standard Input Option Card. Adds two standard inputs to the Model 340. The card has separate A/Ds and excitation for each sensor. A microprocessor on the card manages the A/D and communication with the Model 340. The card allows the Model 340 to read 4 sensors and use any 1 of the sensors as a control sensor. Includes these features:</p> <ul style="list-style-type: none"> • Standard inputs with the ability to select from the front panel to read the following sensors: Diode, Platinum, Cernox, Rox, Germanium, Carbon-Glass, or any thermistor <30 kΩ. • Adds two additional inputs each with its own excitation and A/D. • Specifications match the Model 340 standard inputs.
3464	<p>Dual Thermocouple Input Option Card. Adds two thermocouple inputs to the Model 340. A microprocessor on the card manages the A/D and communication with the Model 340.</p>
3465	<p>Single Capacitance Input Option Card. Adds one capacitance input to the Model 340. A microprocessor on the card manages the A/D and communication with the Model 340.</p>
3468	<p>Eight-Channel Input Option Card. Adds eight additional inputs to the Model 340. Card has 2 Analog-to-Digital (A/D) Converters, one for each group of 4 sensors and individual excitation for each sensor. A microprocessor on the card manages the A/D and communication with the Model 340. The card allows the Model 340 to read a total of 10 sensors. Includes the features below:</p> <ul style="list-style-type: none"> • Eight channels divided into 2 groups of 4. Several sensor types are supported. • Eight individual current sources at 10 μA or 1 mA depending on sensor selection. Each sensor is continuously excited. • Two A/Ds; one for each group.

10.2 ACCESSORIES

Accessories are devices that perform a secondary duty as an aid or refinement to the primary unit.

Model	Description Of Model 340 Accessories
106-009*	Heater Output Connector (Dual Banana Jack). Used for standard Heater Output.
G-106-233*	Sensor Mating Connector. 6-pin DIN Plugs used for sensor inputs; 2 included.
106-737	Terminal Block, 6-pin. Used for Relays Connector. Accepts up to 12 AWG wire.
115-006*	Detachable 120 VAC Line Cord.

* Accessories included with a new Model 340.

Accessories (Continued)

Model	Description Of Model 340 Accessories
268-301	DA-15 D-Style Shell. Used for Digital I/O connector.
268-303	DA-15 D-Style Plug. Used for Digital I/O connector.
2001*	RJ-11 Cable Assembly. Four-Wire Cable Assembly with RJ-11 plugs on each end. Used with RS-232C Interface. Cable is 14 feet (4.6 meters) long. See Figure 10-1.
2002	RJ-11 to DB-25 Adapter. Adapts RJ-11 receptacle to female DB-25 connector. Connects Model 340 to Customer computer rear RS-232C Serial Port. See Figure 10-3.
2003*	RJ-11 to DE-9 Adapter. Adapts RJ-11 receptacle to female DE-9 connector. Connects Model 340 to Customer computer rear RS-232C Serial Port. See Figure 10-2.
3003	<p>Heater Output Conditioner. The heater output conditioner is a passive filter which further reduces the already low Model 340 heater output noise. The typical insertion loss for the Model 3003 is 20 dB at line frequency, and >40 dB from double the line frequency up. A 144 mm × 72 mm × 165 mm (5.67 × 2.84 × 6.5 inches) panel mount enclosure houses this option, weight is 1.6 kilograms (3.5 pounds). See Figure 3-3.</p> <p>The Model 3003 requires no external power. Take care not to reverse the polarity of incoming heater signal. A protection diode on the Model 3003 input acts as a short in case of reversed polarity. It is not necessary to use the ground terminals provided, but in certain circumstances it can help to reduce the noise. Shorting out the filter input or output with the controller driving it turned on is <i>not</i> recommended, as the Model 3003 may have a large stored charge.</p>
3401	Connector Kit.
MAN-340*	Model 340 Temperature Controller User's Manual.
3405-DCARD	Data Card, Flash. For Model 340 update, setup, and curve storage.
3405-SRAM	Data Card, Blank SRAM. For data logging.
3507-1S	Cable Assembly for 1 Sensor. 10 feet long.
3507-2SH	Cable Assembly for 2 Sensors and 1 Heater. 10 feet long.
8000	CalCurve™, Floppy Disk. Consists of breakpoint pairs from a Sensor Precision Calibration loaded on a floppy disk in ASCII format for Customer downloading.
8001-340	CalCurve™, Factory Installed. The Model 8001 provides custom factory programming of specific sensor calibration curves. The Precision Option improves combined sensor and instrument accuracy to within ±0.1 K or better over the calibrated temperature range of the sensor. The Precision Option data is stored in non-volatile memory. Requires a calibrated sensor.
8002-05-340	CalCurve™, Field Installation. Precision option field installation for Model 340 owners. Consists of the break point table from a calibrated sensor stored in the instrument. When ordering, specify your instrument serial number and calibrated sensor model and serial number.
8072	IEEE-488 (GPIB) Computer Interface Interconnect Cable Assembly. This cable assembly is used to connect two IEEE-488 devices. Cable is 1 meter (3.3 feet) in length.

* Accessories included with a new Model 340.

Accessories (Continued)

Model	Description Of Model 340 Accessory
HTR-25	25 Ω, 25 Watt Cartridge Heater. The heater features precision-wound nickel-chromium resistance wire, magnesium oxide insulation, two solid pins, non-magnetic package, and has UL and CSA component recognition. The heater is 25 watt, 6.35 mm (0.25 inch) diameter by 25.4 mm (1 inch) long. The 25 watt rating is in dead air. In cryogenic applications, the cartridge heater can handle many times this dead air power rating.
HTR-25-100	25 Ω, 100 Watt Cartridge Heater. The heater is 100 watt, 6.35 mm (0.25 inch) diameter by 25.4 mm (1 inch) long.
HTR-50	50 Ω, 50 Watt Cartridge Heater. The heater features precision-wound nickel-chromium resistance wire, magnesium oxide insulation, two solid pins, non-magnetic package, and has UL and CSA component recognition. The heater is 50 watt, 6.35 mm (0.25 inch) diameter by 25.4 mm (1 inch) long. The 50 watt rating is in dead air. In cryogenic applications, the cartridge heater can handle many times this dead air power rating.
RM-1	Rack Mounting Kit. Mounting brackets, ears, and handles to attach one Model 340 to a 482.6 mm (19-inch) rack mount cabinet. See Figure 10-4.
Wire	Lake Shore Cryogenic Wire. Lake Shore sells the following types of cryogenic wire: WNC = Nichrome Heater, WSL = Single Strand, WQT = Quad-Twist™, WDT = Duo-Twist™, WDL = Duo-Lead, WQL = Quad-Lead™, WMW = Manganin, and WHD = Heavy Duty. Please refer to the Lake Shore Catalog for details.

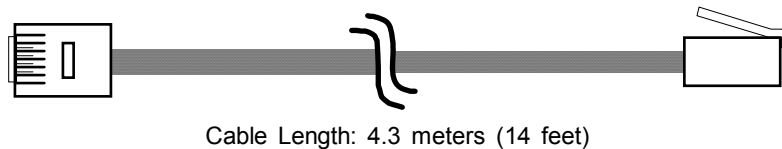

340-10-1.eps

Figure 10-1. Model 2001 RJ-11 Cable Assembly

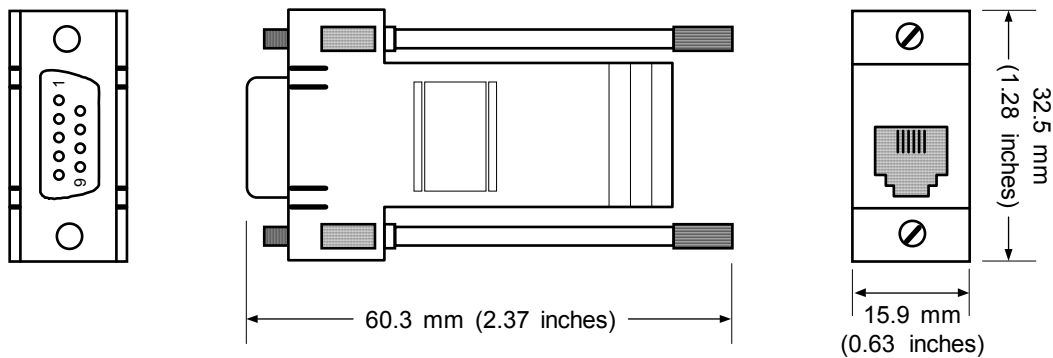

340-10-2.eps

Figure 10-2. Model 2003 RJ-11 to DE-9 Adapter

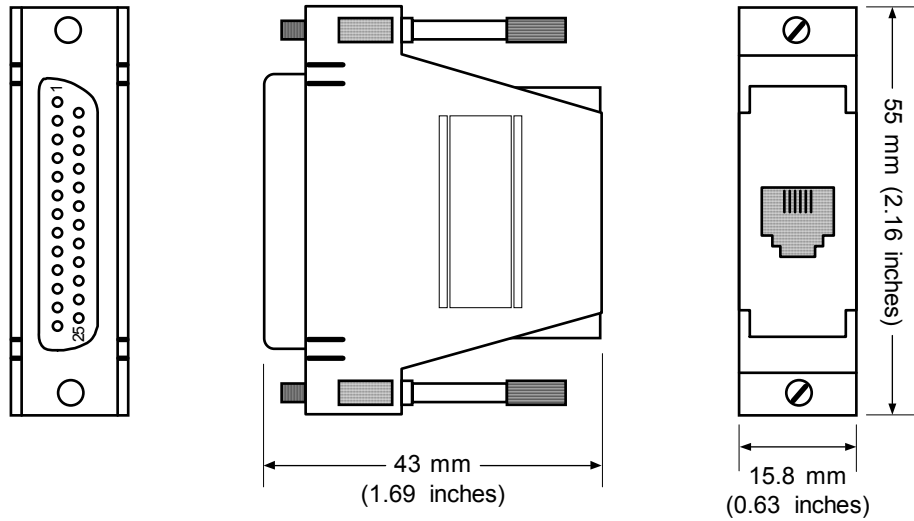

340-10-3.eps

Figure 10-3. Optional Model 2002 RJ-11 to DB-25 Adapter

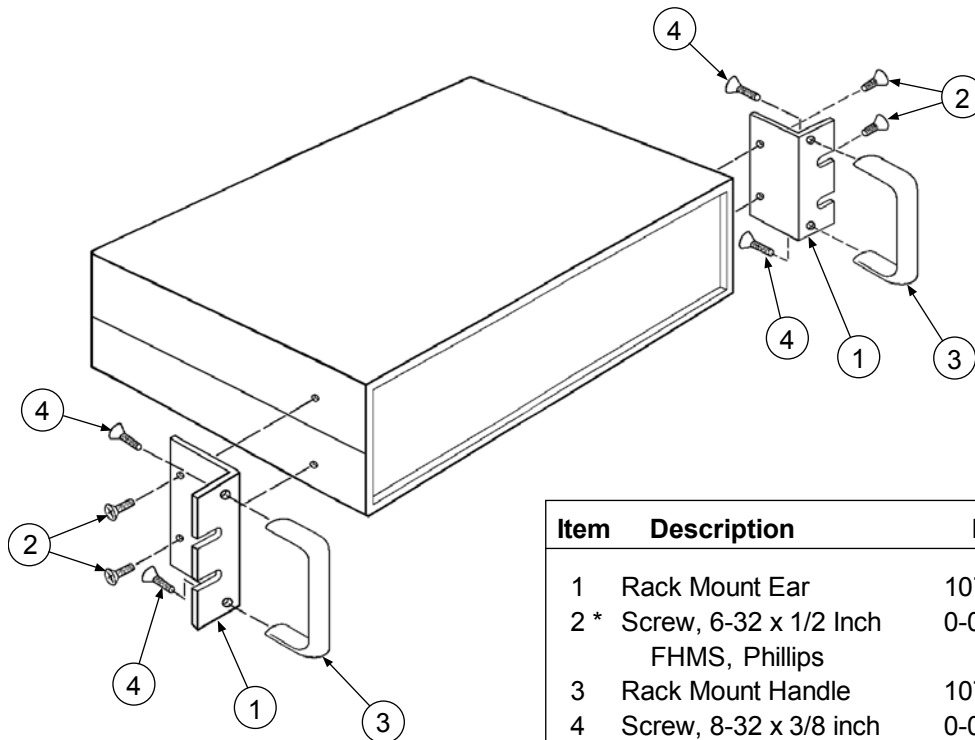

Item	Description	P/N	Qty
1	Rack Mount Ear	107-049	2
2 *	Screw, 6-32 x 1/2 Inch FHMS, Phillips	0-035	4
3	Rack Mount Handle	107-433	2
4	Screw, 8-32 x 3/8 inch FHMS, Phillips	0-081	4

NOTE

* Remove and discard four screws from front.
Replace with four longer screws (Item 2).

340-10-4.eps

Figure 10-4. Model 3012 Rack-Mount Kit

10.3 MODEL 3462 DUAL STANDARD INPUT OPTION CARD

The Model 3462 Input Card adds two standard inputs to the Model 340 Temperature Controller. The inputs appear as C & D on the display. The original standard inputs remain fully functional.

10.3.1 Field Installation

The Model 3462 Option kit adds two optional sensor inputs to the Model 340 instrument rear panel. It includes:

- (1) 10-conductor ribbon cable
- (1) 3462 Option Card
- (4) 1¼-inch metal standoffs
- (8) 4-40 machine screws

Required tools: Small Phillips-head screwdriver and 5/64-inch Allen wrench.

CAUTION: The components on this board are electrostatic discharge sensitive (ESDS) devices. Wear shock-proof wrist straps (resistor limited to <5 mA) to prevent injury to service personnel and to avoid inducing an electrostatic discharge (ESD) into the device.



1. Turn Model 340 power switch OFF. Unplug power cord from wall outlet, then instrument.
2. Stand the unit on its face. Use the Allen wrench to remove the 4 screws on each side of the covers (Figure 10-5).
3. Use the small Phillips screwdriver to remove any top and bottom cover screws; instruments may have 1 or 2 screws on the top and bottom covers.
4. Remove rear plastic bezel. The covers are tracked. Slide the top and bottom covers to the rear on the tracks to remove them.
5. Remove rear panel option plate screws and set aside. Remove rear panel option plate.

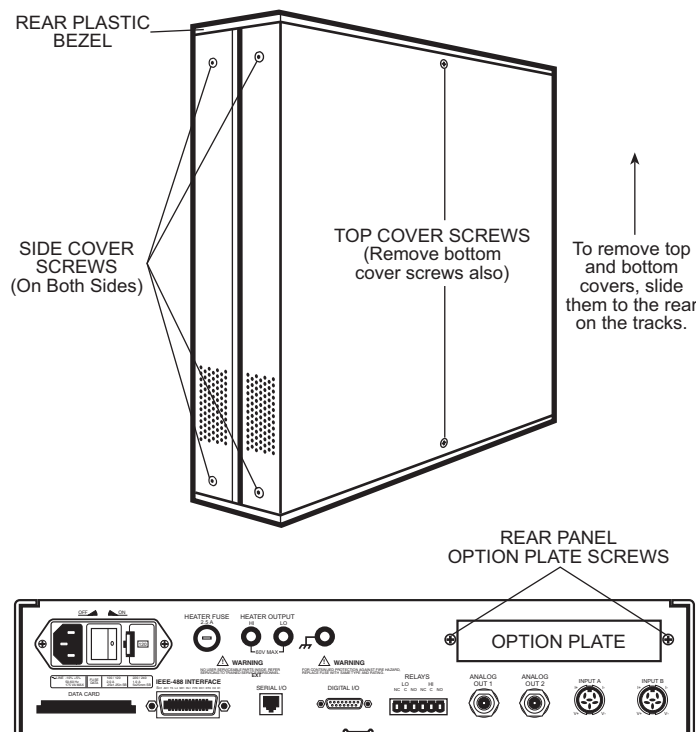

Figure 10-5. Cover and Option Plate Screws

6. With the instrument still standing on its face, turn it to view the circuit board. The upper half of the circuit board above the transformer assembly contains four holes where metal standoffs install (Figure 10-6). Find Hole #1 to the left between C245 and C265. Find Hole #2 4.5 inches to the right of Hole #1, and just to the left of C298 and U154. Find Hole #3 4.5 inches to the right of Hole #2, and just to the left and below the Digital Option plug (J9). Find Hole #4 2.5 inches above Hole #3, just to the left and above the Digital Option plug (J9). Ignore hole to left and beneath Hole #4. Into each hole, insert a 4-40 screw through the bottom of the circuit board, and thread it into a metal standoff on the top of the circuit board.
7. Just beneath the transformer assembly is the Analog Option plug (J18). Plug either end of the ribbon cable into the Analog Option plug (J18). Slide the arrow nub down the plug slot for correct positioning.

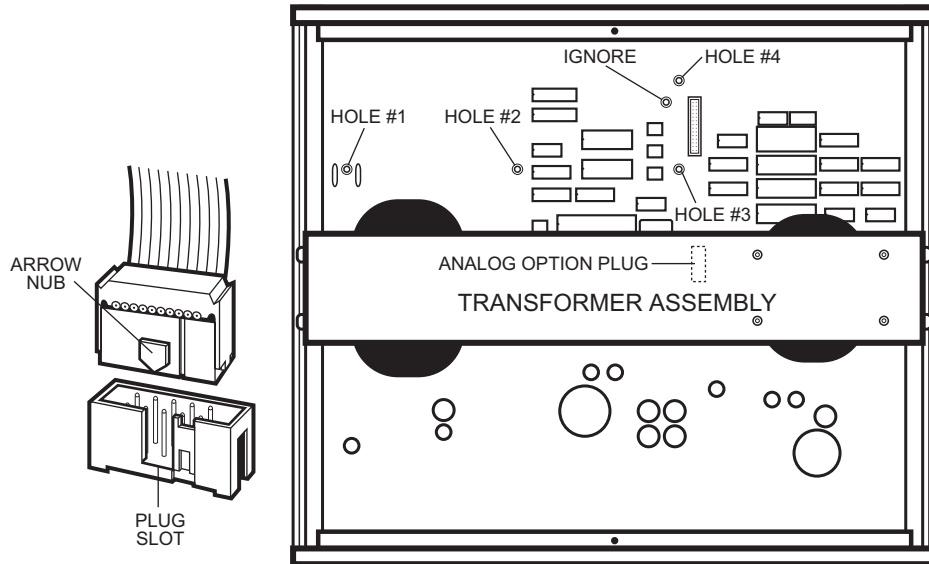

Figure 10-6. Model 340 Mounting Holes and Analog Option Plug

8. Plug the other end of the ribbon cable into the 3462 Option Card plug (J3) located on the lower right corner of the card (Figure 10-7).
9. Place the 3462 Option Card on top of the metal standoffs in the instrument. Fit the 3462 sensor inputs out the rear panel option opening. Retrieve option plate screws from Step 5 and use to slightly tighten the 3462 Option Card to the rear panel.
10. Align the holes in the card with the corresponding metal standoffs. Insert a 4-40 screw through each 3462 Option Card hole and thread it into the metal standoff beneath. Go back and tighten the two screws securing the option card to the rear panel.

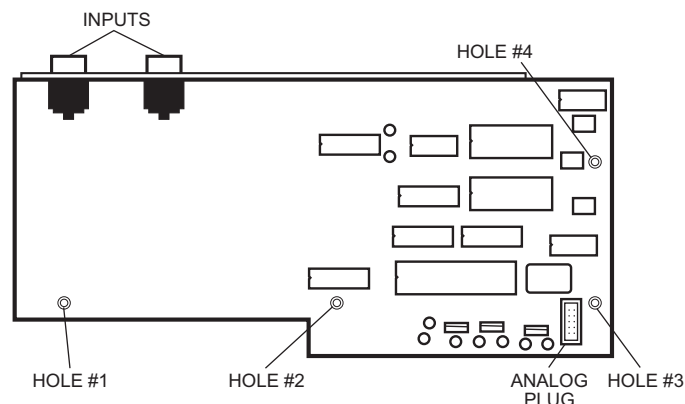

Figure 10-7. Mounting Holes & Analog Plug

11. Stand instrument on face. Slide top and bottom covers on. Reposition rear plastic bezel, then rethread all cover screws. The completed installation should look like Figure 10-8.
12. Replace power cord. Turn on power switch. To verify 3462 Option Card installation, press **Options**, then press **More** three times. The Model 340 displays the 3462 option in the REVISION INFORMATION.

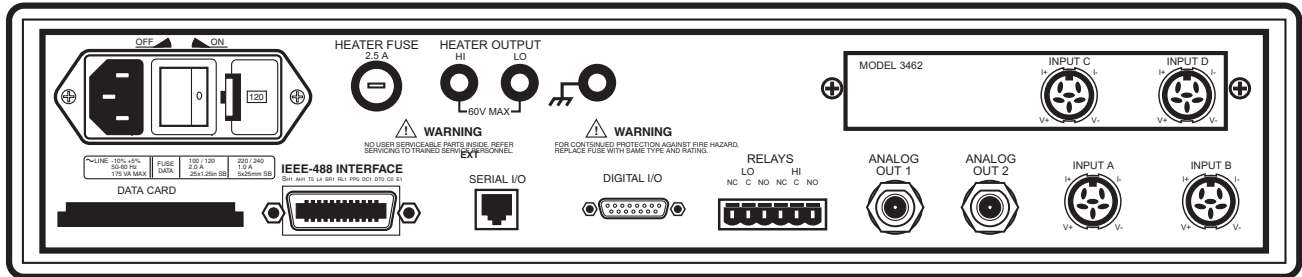

Figure 10-8. Model 340 Rear Panel with Model 3462 Option Card Installed

10.3.2 Operation

This Model 340 unit now functions with two additional inputs called “C” and “D”. All menus that allow input channel selection scroll from “A” to “D” and back again. Example: Press **Display Format** to show the Reading Display Format screen. Press **Enter** to highlight the “Disp:” field. Use the **▲** or **▼** key to scroll through the inputs.

10.3.3 Specifications

The 3462 Option Card input specifications are the same as for standard inputs on the Model 340 main board listed in Table 1-2.

10.4 MODEL 3464 DUAL THERMOCOUPLE INPUT OPTION CARD

10.4.1 General

The Model 3464 Option Card adds two thermocouple inputs to the Model 340 Temperature Controller. They appear on the Model 340 display as **C** and **D**. Use them for temperature measurement and control with a wide variety of thermocouple sensors. The standard instrument inputs remain fully functional.

The 3464 option using the Input Setup menu can select 2 distinct input ranges to accommodate both cryogenic and high temperature operation. Turn the built-in room temperature compensation on or off through the keypad or remote interfaces.

A thermocouple is a common sensor to measure temperature. Two dissimilar metals joined at one end produce a small unique voltage at a given temperature. The 3464 thermocouple hardware and software measures and interprets this voltage.

Thermocouples are available in different combinations of metals or calibrations. The four most common thermocouples for cryogenic applications are Chromel-AuFe, K, T and E. The Model 340 with a 3464 option provides 5 standard curves. Users may enter custom curves.

Each thermocouple has a different temperature range and environment, although the maximum temperature varies with the diameter of the wire used in the thermocouple. Special techniques are required to approach accuracy of 1% of temperature, even without consideration for the effects of high magnetic fields or high radiation fluxes.

10.4.2 Option Installation

The Model 340 instrument supports only one option board at a time. To install the 3464 Option into a Model 340 follow the installation procedure in Paragraph 10.3.1.

To verify if an option is installed simply view the Model 340 rear panel. Options mount above the normal inputs marked A and B. To identify an option installed in a Model 340, press **Options**, then press **More** three times. Option identification displays on the REVISION INFORMATION screen.

If options board are changed, the Model 340 changes all parameter settings to default, but erases no sensor curves entered for optional sensor types.

10.4.3 Sensor Installation

Sensor connection is important when using thermocouples because the measured signal is small. Many measurement errors can be avoided with proper sensor installation.

CAUTION: Do not leave inputs unconnected to float. Short channels when not in use.

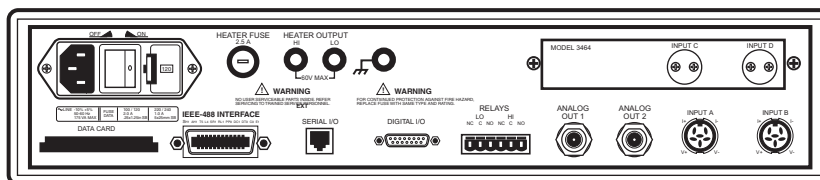

Figure 10-9. Model 340 Rear Panel with Model 3464 Option Card Installed

10.4.3.1 Sensor Input Terminals

Attach sensor leads to the screws on the off-white ceramic terminal blocks on the 3464. There is one block for the C input and one for the D input. Each block has two screw terminals; one positive (+), one negative (-).

Table 10-1. Thermocouple Polarity

	Positive (+)	Negative (-)
Chromel-AuFe0.07%	Chromel	Gold
Chromel-AuFe0.03%	Chromel	Gold
E (Nickel-Chromium vs. Copper-Nickel)	Chromel (PUR)	Constantan (RED)
K (Nickel-Chromium vs. Nickel-Aluminum)	Chromel (YEL)	Alumel (RED)
T (Copper vs. Copper-Nickel)	Copper (BLU)	Constantan (RED)

Secure the positive TC wire under the screw in the (+) terminal and the negative TC wire under the screw in the (-) terminal. Tighten the screws on the thermocouple wires and remove all insulation.

Keep the ceramic terminal blocks away from heat sources including sunlight and shield them from fans or room drafts.

10.4.3.2 Measurement Point Connection

Thermocouples are commonly used in high-temperature applications. Cryogenic use of thermocouples offers some unique challenges. Refer to Paragraph 2.3 for general installation guidelines. Consider the following when using thermocouples at low temperatures:

- Thermocouple wire is generally more thermally conductive than other sensor lead wire. Smaller gauge wire and more heat sinking may be needed to prevent leads from heating the sample.
- Attaching lead wires and passing through vacuum tight connectors are often necessary in cryogenic systems. Remember, the thermocouple wire *is* the sensor; any time it joins or contacts other metal, there is potential for error.
- Temperature verification and calibration of room temperature compensation is difficult after the sensor is installed. When possible, keep a piece of the same wire installed in a system for future use.

10.4.3.3 Grounding and Shielding

For lowest measurement noise, do not ground thermocouple sensors. The instrument usually operates with more noise if one of the thermocouples is grounded. Grounding both thermocouples is not recommended.

The instrument does not offer a shield connection on the terminal block. Twisting the thermocouple wires helps reject noise. If shielding is necessary, extend the shield from the oven or cryostat to cover the thermocouple wire, but do not attach the shield to the instrument.

10.4.4 Operation

10.4.4.1 Default Settings

Following the installation, the 3464 option adds 2 new inputs to the standard front panel operations. This allows configuration of inputs C and D assigned as thermocouple inputs.

When the instrument is first powered on the default settings for channels C and D are range is ± 50 mV range, temperature compensation is turned ON, and curve 0 (NO CURVE) is selected. If the option card is replacing another option card all configuration parameter are set to defaults.

10.4.4.2 Input Selection

After installation, the 3464 option adds 2 new inputs to standard front panel operations, which allows configuration of inputs **C** and **D** assigned as thermocouple inputs. For example, press **Input Setup** to display the INPUT SETUP screen. The **▲** or **▼** key to cycle through inputs **A**, **B**, **C**, or **D**. If **C** or **D** is selected, press **Enter** to display available settings for that thermocouple.

With no option present, only **A** and **B** inputs are available.

10.4.4.3 Displaying Option Readings

Readings from option inputs **C** and **D** can be always be displayed in sensor units, millivolts. If a temperature response curve is selected for an input, its readings can also be displayed in temperature.

To add an input reading to the display, press the Display Format key.

10.4.4.4 Curve Selection

To read temperature from the 3464 option, select a temperature curve for the Model 340. If no curve is selected, the Model 340 reads in sensor units (millivolts), and if the display is configured to show temperature for that channel a NO CURVE message displays for that channel. To select a temperature response curve, press **Input Setup**.

There are 5 standard thermocouple curves included in the Model 340. The user may enter curves of any thermocouple type. Only curves in mV/K data format display during curve selection. Refer to Appendix A for lists of data points in each curve.

Table 10-2. Standard Thermocouple Curves

Curve Number	Type	±25 mV Range*	±50 mV Range*
6	K	3.15 K to 864 K	3.15 K to 1500 K
7	E	3.15 K to 622 K	3.15 K to 930 K
8	T	3.15 K to 670 K	3.15 K to 670 K
9	Chromel-AuFe 0.03%	3.50 K to 500 K	3.50 K to 500 K
10	Chromel-AuFe 0.07%	3.15 K to 610 K	3.15 K to 610 K

* Temperature ranges are without temperature compensation.

10.4.4.5 Curve Data Format

Users may enter temperature response curves for all types of thermocouples. Enter curve data in mV/K format with thermocouple voltage in millivolts and temperature in Kelvin.

The curve must be normalized to 0 mV at 273.15 K (0 °C). Thermocouple voltages in millivolts are positive when temperature is above that point and negative when temperature is below that point.

To convert curves published in Celsius to Kelvin, add 273.15 to the temperature in Celsius.

The temperature range for some thermocouple types may extend below 1 K or above 1000 K. The input voltage of the 3464 is limited to ±50 mV, so any part of the curve that extends beyond ±50 mV is not usable by the instrument.

A message of S-OVER or S-UNDER on the display indicates that the input is over or under the ±50 mV range.

10.4.4.6 Range Selection

The 3464 option inputs have two input voltage ranges: ±25 mV and ±50 mV. Range selection depends on the Thermocouple type and expected operating temperature. ±25 mV is recommended for cryogenic applications or higher temperatures that produce less than 500 K. For temperatures above 500 K, the ±50 mV range is recommended because thermocouple voltage can exceed 25 mV on some thermocouple types. Select the range that matches the operating temperature.

The thermocouple temperature response curve can help when choosing an input range. Room temperature compensation can limit the useable range. The voltage range for inputs C and D is set independently. To select an input range, press **Input Type**.

10.4.4.7 Room Temperature Compensation

Room temperature compensation must be used to correct for the voltage difference between temperature response curves normalized to 273.15K and instrument operating temperature, room temperature. An external ice bath is the most accurate form of compensation, but is often inconvenient. The 3464 has built-in room temperature compensation that is adequate for most applications. The built-in compensation can be turned on or off by the user. It will operate with any thermocouple type that has an appropriate temperature response curve loaded. Calibration of the built-in compensation is recommended when a thermocouple is first installed or any time a thermocouple is changed.

To turn room temperature compensation on or off, press **Input Setup**. The input setup setting screen appears with the input letter in the top left hand corner. Use the **▲** or **▼** key to select an input. Press **Enter** to display parameters for that input. Press **Next Setting** until the room compensation (**Room Comp**;) field highlights, then use the **▲** or **▼** key to select on or off. Press **Save Screen** to store the changes in the Model 340. The default setting is On.

Room Temperature Calibration Procedure

Field calibration of room temperature compensation is important. Factory calibration is accurate to within ± 1 K. Differences in thermocouple wire and installation technique account for most of that error.

Achieve the best accuracy by calibrating the thermocouple used. If that is not possible, use a thermocouple made from the same wire. For less demanding applications, a short across the input terminals will work. Calibrate both inputs even if they use the same type of thermocouple.

1. Attach thermocouple sensor or direct short across input terminals of input **C** or **D**. Refer to Table 10-1 for polarity.
2. Place the instrument away from drafts with an accurate room temperature thermometer near the thermocouple or terminal block.
3. Allow the instrument to warm up for at least one half hour without moving it or handling the sensor.
4. Insert the Thermocouple into the ice-bath, liquid nitrogen, or helium dewar. This temperature should be close to the measurement temperature. The further away the operating temperature is from the Room Compensation temperature the greater the chance of error.
5. Read the displayed temperature. Standard laboratory practices are expected, the temperature at the top of a dewar of liquid nitrogen is different from the bottom. If the temperature display is not as expected, check where the Thermocouple is contacting the liquid. Or possibly, add a thermal mass to the end of the Thermocouple that is being dipped.
6. Press **Input Type**, select input **C** or **D**, and press **Enter**. Press **Next Setting** until the **Room Comp** field highlights, then press **Enter**. Use the **▲** or **▼** key to select EXECUTE, and press **Enter**.
7. A pop up menu appears with the currently read temperature displayed. Enter the true temperature that the Thermocouple should read. If inputs are shorted, then enter the actual room temperature measured by a thermometer device.
8. Press **Save Screen** to complete the calibration for that input.
9. The Model 340 turns internal room temperature compensation ON when calibration completes. To verify calibration, check that the temperature reading for the calibrated input matches the room temperature calibration setting value.

10.4.5 Computer Interface Commands

Most of the computer interface commands used by the Model 340 are independent of installed options or sensor type. The following commands or formats change when the 3464 is installed.

1. In command strings the <input> field accepts **A**, **B**, **C**, or **D** instead of only **A** and **B**.
2. Sensor units for inputs **C** and **D** are millivolts(mV).
3. The INSET command changes to the following format. The INSET? query changes accordingly.

INSET <input>,[<enable>],[<compensation>]

<input>: Specifies input to configure: (**C** or **D**).

<enable>: Specifies whether input is allowed to read.

<compensation>: Room temperature compensation *not* thermal EMF compensation.

4. The INTYPE command changes to the following format. The TYPE? query changes accordingly.

INTYPE <input>,,,,,<range>

<input>: Specifies input to configure: (**C** or **D**).

<range>: Specifies input voltage range: **1** = 25mV, **2** = 50mV.

10.4.6 Thermocouple Temperature Curves

Refer to Appendix A for lists of data points in each curve and Table 1-2 for thermocouple sensor performance.

10.4.7 Specifications

The 3464 Option Card input specifications are listed in Table 1-2.

10.5 MODEL 3465 SINGLE CAPACITANCE INPUT OPTION CARD

This option adds a capacitance input to the Model 340 Temperature Controller. The new input appears on the display as **C**. It controls temperature in strong magnetic fields using Lake Shore Model CS-401 or CS-501 capacitance temperature sensors. The standard inputs remain in the instrument and are fully functional.

The Model 340 does not support temperature conversion for the capacitance input. The temperature response of capacitance sensors shifts with thermal cycling, making calibration unpredictable. All 3465 option measurement and control must be done in sensor units.

With this option, we recommend operating the Model 340 with two sensors installed at the control point. Use a diode or resistive sensor in one of the standard inputs to establish a control temperature and stabilize the system in a low magnetic field. Then shift control to the capacitance sensor before increasing field strength.

10.5.1 OPTION INSTALLATION

To install the 3465 Option into a Model 340 follow the installation procedure in Paragraph 10.3.1. Only one option board can be installed in the Model 340 at a time. To verify which option if any is installed in a Model 340, press **Options**, then press **More** three times. Option identification displays on the **REVISION INFORMATION** screen. If options change, the Model 340 changes all parameter settings to default.

10.5.2 SENSOR INSTALLATION

10.5.2.1 Sensor Input Connector

A six-pin connector on the 3465 attaches the four sensor leads and shields. Capacitance temperature sensors are commonly two-lead devices, but four-lead measurement is recommended. Make the change from four-lead to two-lead as close to the sensor as practical.

Capacitance temperature sensors are not polarized; use either lead as the positive or negative lead. However, 3465 option measurement is polarity dependent; be sure to attach the V+ and I+ to one sensor lead and the V– and I– to the other.

Model 3465 Input Connector	
1	I–
2	V–
3	Ground
4	V+
5	I+
6	Shield

10.5.2.2 Measurement Point Connection

Refer to Paragraph 2.3 for general installation guidelines for any cryogenic sensor. When using a capacitance sensor the AC excitation must also be considered.

It is often necessary to place the capacitance sensor very near a second control sensor. The 4.88 kHz excitation of the 3465 option can interfere with the sensitive DC measurements of the standard inputs. Tightly twist the lead wires of each sensor and separate them from the leads from the other sensor. Test any system for sensor interference before it is permanently sealed.

10.5.2.3 Grounding and Shielding

For lowest measurement noise, do not ground any sensor leads. The instrument usually operates with more noise if one of the leads is grounded. Grounding more than one lead is not recommended.

Shielded cable is recommended because of the AC excitation of the sensor. Shielding reduces excitation noise transmitted into the measurement system. Shielding outside the cryostat is recommended, but it is difficult to use shields inside. Connect a cable shield to the ground pin 3 of the input connector, but do not connect at the other end. Use driven shield pin 6 of the Input connector instead of pin 3 if attaching to pin 3 does not give the desired results. Inside the cryostat, tightly twist the sensor leads: V+ to V– and I+ to I–.

10.5.3 Operation

10.5.3.1 Input Selection

After Model 3465 option installation, front panel operation allows configuration of input **C** assigned to the capacitance input. Without the option, only **A** and **B** inputs are available. For an example of option input selection, press **Input Setup** to display the **INPUT SETUP** screen. Use the **▲** or **▼** key to select inputs **A**, **B**, or **C**. Select **C** and press **Enter** to display available settings for the option.

10.5.3.2 Displaying Option Readings

Readings from option input **C** display in sensor units, nanofarads (nF). To add an input reading to the display, press **Display Format**.

10.5.3.3 Curve Selection

The Model 340 with a 3465 option does not support temperature conversion so no temperature response curves can be selected. Any feature of the Model 340 that requires temperature to operate is not supported with the 3465 option. Selecting temperature units results in a NO CURVE message or display 0K.

10.5.3.4 Range Selection

The Model 3465 option input has two input voltage ranges, 15 nF and 150 nF. The lower range is specified to 15 nF, but can read up to 25 nF, and is recommended for CS-401 series sensors. The higher range, is specified to 150 nF, but can read up to 250 nF, and is recommended for CS-510 series sensors. To select an input range, press **Input Type**.

10.5.3.5 Temperature Coefficient

Capacitance sensors can have both a positive and negative temperature coefficient (slope). They have a positive temperature coefficient at very low temperatures and a negative temperature coefficient at warmer temperature. Sensor data sheets detail where the coefficient changes. There is often a temperature range where the sensor is not usable.

Temperature control is impossible if the Model 340 does not know which slope the sensor is on. System overheating can result if the wrong coefficient is chosen. The user must select a temperature coefficient before control is switched to the 3465 input. To select a temperature coefficient, press **Input Type**.

10.5.3.6 Control Channel Changes

The 3465 option continues control at a stable temperature established with another sensor. Allow temperature to stabilize for one hour after large temperature changes to allow capacitance sensor recovery.

When the control channel is changed to the capacitance input, the Model 340 changes the control setpoint to the present capacitance reading. It is not necessary for the user to write down the capacitance value and enter a new setpoint. Control parameters, P and I, may need to be changed for stable control. To change control channel, press **Control Channel**.

10.5.4 Computer Interface Commands

Most of the computer interface commands used by the Model 340 are independent of installed options or sensor type. The following commands or formats change when the 3465 is installed.

1. In command strings the <input> field accepts A, B or C instead of only A and B.
2. The INTYPE command changes to the following format. The TYPE? query changes accordingly.

INTYPE <input>,,,<coefficient>,,<range>

<input>: Specifies input to configure: **C** .

<coefficient>: Temperature coefficient: **1** = negative, **2** = positive.

<range>: Input range: **0** = 15pF, **1** = 150 pF.

<excitation>: **0**

<type>: **11** - Capacitance

<units>: **3** (nanofarads)

10.5.5 Specifications

The 3465 Option Card input specifications are listed in Table 1-2.

10.6 MODEL 3468 EIGHT-CHANNEL INPUT OPTION CARD

10.6.1 General

The 3468 option adds 8 sensor inputs to the Model 340 Temperature Controller. The original standard inputs remain fully functional allowing the Model 340 to measure 10 sensors when the option is installed. The optional inputs are broken into two groups of four and appear on the display as **C1—C4** for Input C, **D1—D4** for Input D. The option card includes two A/D converters, one for each group of four inputs, and individual excitation for each sensor. Each group of inputs must use the same sensor type, but the two groups can be different. Calibration for the option is stored on the card so it can be installed in the field without recalibration.

The 3468 option supports all the sensors as the Model 340 standard inputs. Diode and Platinum configurations have similar specifications to the standard inputs, reduced only slightly to account for multiplexing. However, the NTC RTD configuration is quite different than the standard inputs. The option has a limited resistance range of 7.5 k Ω with a fixed current excitation of 10 μ A, compared to the 300 k Ω resistance range and voltage excitation available on the standard inputs. This limitation significantly reduces the low temperature range of the inputs. The option also does not support current reversal to reduce the effect of thermal EMF voltages.

10.6.2 Option Installation

The 3468 can be installed into a Model 340 at the factory or in the field. To field install a 3468 option follow the installation procedure in Paragraph 10.3.1. Only one option board can be installed in the Model 340 at a time. To verify which option, if any, is installed in a Model 340 press **Options**, and then press **More** three times. Option identification displays on the **REVISION INFORMATION** screen. If options are changed, the Model 340 changes all parameter settings to default.

10.6.3 Sensor Installation

10.6.3.1 Sensor Input Connector

Two 25 pin D subminiature receptacles hold connections for the **C1-C4** and **D1-D4** sensor inputs. They mate with 25 pin D subminiature plugs (Lake Shore P/N 106-253) included with the option. Additional mating connectors can either be ordered from Lake Shore or purchased from local electronics distributors. Figure 10-10 illustrates pin assignments and pin numbering as seen from the rear of the option card.

It is possible for an overload condition on one channel to affect the reading on another in the same input group so unused sensor inputs should have all four connections shorted together. Wire redundant sensors in separate groups for best reliability. Split fewer than eight sensors evenly between input groups for best reading efficiency.

10.6.3.2 Sensor Input Cabling

Twisted shielded cable is recommended for wiring to the 3468 outside of the cryostat. Cable shields should be connected to the shield (S) pins of the input connector. There are enough shield pins in to connect an individual shield for each input if necessary. The body of the connector is at earth ground and not the options measurement common; therefore it does not make an effective shield. The connector body should not be connected to any signal or shield lines during measurement because it can cause ground loop noise.

10.6.3.3 Reading Rate

Both inputs update every 400 milliseconds when fully loaded with sensors. Update rate improves with fewer active sensors in a group of four as shown below. To disable unused sensor inputs use the Input Setup screen (Paragraph 10.6.4.2).

# of enabled channels	Update rate	# of readings / second
1	50 ms	20
2	200 ms	5
3	300 ms	3.3
4	400 ms	2.5

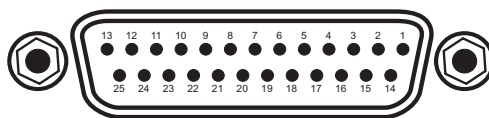

25-Pin Connector.eps

Input Connector (Input C)				Input Connector (Input D)			
PIN	DESC.	PIN	DESC.	PIN	DESC.	PIN	DESC.
1	NC			1	NC		
2	S	14	S	2	S	14	S
3	C1I+	15	C1I-	3	D1I+	15	D1I-
4	C1V+	16	C1V-	4	D1V+	16	D1V-
5	S	17	S	5	S	17	S
6	C2I+	18	C2I-	6	D2I+	18	D2I-
7	C2V+	19	C2V-	7	D2V+	19	D2V-
8	S	20	S	8	S	20	S
9	C3I+	21	C3I-	9	D3I+	21	D3I-
10	C3V+	22	C3V-	10	D3V+	22	D3V-
11	S	23	S	11	S	23	S
12	C4I+	24	C4I-	12	D4I+	24	D4I-
13	C4V+	25	C4V-	13	D4V+	25	D4V-

Figure 10-10. Sensor Input Connector

10.6.4 Operation

10.6.4.1 General Operation

When the 3468 option is installed the Model 340s front panel allows configuration of **C1—C4**, **D1—D4** inputs on most menu screens along with the standard **A** and **B** inputs. Follow instructions in this manual for the **A** and **B** inputs and **C** and **D** can be accessed from the setting screens when available.

For an example of option input selection, press **Input Setup** to display the **INPUT SETUP** screen. Use the **Up Arrow** and **Down Arrow** keys to select inputs **A**, **B**, **C**, or **D**. Select **C** or **D** and press **Enter**. Use the **Up Arrow** and **Down Arrow** keys to select a channel, **1-4**, for the selected input. Press **Enter** again to display available settings for the option.

10.6.4.2 Input Setup

In the **INPUT SETUP** screen, **Enable**, **Curve**, and **Type** can be changed. Only **Enable** and **Curve** can be different for the channels in an input group. **Type** must be the same for all sensors in the group. **Sensor Unit**, **Temp Coeff**, **Excitation**, and **Range** of the selected sensor type are shown for references only and cannot be changed independent of the type setting.

10.6.4.3 Temperature Control

Any of the optional sensors can be chosen as the control channel for either control loop. Control from an option input is not recommended in most applications because the multiplexing necessary to read all channels can disrupt control. Good control performance can be achieved when the other three channels in an input group are disabled.

10.6.5 Computer Interface Commands

Most of the computer interface commands used by the Model 340 are independent of installed options or sensor type. The following commands or formats change when the 3468 is installed.

1. In most command strings the <input> field accepts A, B or C1—C4, D1—D4 instead of only A and B.
2. The INTYPE command changes to the following format for 3468 inputs.

INTYPE <input>,<type>

<input>: Specifies input to configure: C or D.

<type>: Specifies input sensor type. Valid entries:

- | | | |
|-------------------------|-------------------------|-------------|
| 1 = Silicon Diode | 4 = Platinum 100 (500Ω) | 7 = NTC RTD |
| 2 = GaAIAs Diode | 5 = Platinum 1000 | |
| 3 = Platinum 100 (250Ω) | 6 = Rhodium Iron | |

Example: INTYPE C,1 – Sets sensor type to silicon diode for all C channels.

3. The INTYPE? query changes to the following format.

INTYPE? <input>

<input>: Specifies input to query: C or D.

Returned: <type>,<units>,<coefficient>,<excitation>,<range>

<type>: See the INTYPE command.

<units>: Sensor units: 1 = volts, 2 = ohms.

<coefficient>: Temperature coefficient: 1 = negative, 2 = positive.

<excitation>: Input excitation: 6 = 10 μA, 10 = 1mA.

<range>: Input range: 8 = 250mV 11 = 2.5V 13 = 7.5V
 9 = 500mV 12 = 5V 14 = 75mV

10.6.6 Specifications

The 3468 Option Card input specifications are listed in Table 10-3.

Supported Lake Shore Sensors *

Type	Model	Temp. Range
Diodes		
Silicon Diode	DT-470	1.4–475 K
Silicon Diode	DT-670	1.4–500 K
GaAIAs Diode	TG-120	1.4–475 K
Positive Temperature Coefficient RTDs		
100 Ω Platinum	PT-100, 250 Ω Full Scale	30–675 K
100 Ω Platinum	PT-100, 500 Ω Full Scale	30–800 K
Rhodium-Iron	RF-800-4	4–400 K
Negative Temperature Coefficient RTDs		
Germanium	GR-200A-1000	2–100 K
Germanium	GR-200A-250	1.2–40 K
Carbon Glass™	CGR-1-500	3–400 K
Cernox™	CX-1050 AA or SD	3.5–400 K
Cernox™	CX-1030 AA or SD	2–325 K
Rox™	RX-102A	3–200 K
Rox™	RX-202A	3–300 K
Thermox™	TX-104-GB	110–325 K

* Sensors sold separately.

Table 10-3. Model 3468 Sensor Input Performance Chart

Sensor Type	Silicon Diode	GaAlAs Diode	100 Ω Platinum RTD 500 Ω Full scale	1000 Ω Platinum RTD	Cernox™ RTD
Temperature Coefficient	Negative	Negative	Positive	Positive	Negative
Sensor Units	Volts (V)	Volts (V)	Ohms (Ω)	Ohms (Ω)	Ohms (Ω)
Input Range	0 – 2.5 V	0 – 7.5 V	0 – 500 Ω	0 – 5000 Ω	0 – 7500 Ω
Sensor Excitation (Constant Current)	10 μA ±0.01%	10 μA ±0.01%	1 mA ±0.3%	1 mA ±0.3%	10 μA ±0.01%
Display Resolution Sensor Units	100 μV	100 μV	10 mΩ	100 mΩ	100 mΩ
Example Lake Shore Sensor	DT-470-CO-13 with 1.4H calibration	TG-120SD with 1.4H calibration	PT-103 with 14J calibration	PT-1001* with 1.4G calibration	CX-1050-SD with 4L calibration
Temperature Range	1.4 – 475 K	1.4 - 475 K	30 – 800 K	30 – 800 K	3.5 – 400 K
Standard Sensor Curve	Lake Shore Curve 10	Requires calibrated sensor	DIN 43760	Scaled from DIN 43760	Requires calibrated sensor
Typical Sensor Sensitivity†	-30 mV/K at 4.2 K -1.9 mV/K at 77 K -2.4 mV/K at 300 K -2.2 mV/K at 475 K	-180 mV/K at 10 K -1.25 mV/K at 77 K -2.75 mV/K at 300 K -2.75 mV/K at 475 K	0.19 Ω/K at 30 K 0.42 Ω/K at 77 K 0.39 Ω/K at 300 K 0.35 Ω/K at 675 K 0.33 Ω/K at 800 K	1.9 Ω/K at 30 K 4.2 Ω/K at 77 K 3.9 Ω/K at 300 K 3.4 Ω/K at 675 K	-770 Ω/K at 4.2 K -1.5 Ω/K at 77 K -0.1 Ω/K at 300 K
Measurement Resolution: Sensor Units Temperature Equivalence	20 μV 1 mK at 4.2 K 11 mK at 77 K 10 mK at 300 K 10 mK at 475 K	20 μV 1 mK at 10 K 16 mK at 77 K 10 mK at 300 K 10 mK at 475 K	2 mΩ 10.6 mK at 30 K 10 mK at 77 K 10 mK at 300 K 10 mK at 675 K 10 mK at 800 K	20 mΩ 10.6 mK at 30 K 10 mK at 77 K 10 mK at 300 K 10 mK at 800 K	50 μV 1 mK at 4.2 K 33.3 mK at 77 K 500 mK at 300 K
Electronic Accuracy: Sensor Units Temperature Equivalence	±160 μV ±0.01% of reading ±11 mK at 4.2 K ±138 mK at 77 K ±88 mK at 300 K ±77 mK at 475 K	±160 μV ±0.02% of reading ±6 mK at 10 K ±300 mK at 77 K ±150 mK at 300 K ±110 mK at 475 K	±0.004 Ω ±0.02% of reading ±25 mK at 30 K ±18 mK at 77 K ±70 mK at 300 K ±162 mK at 675 K ±187 mK at 800 K	±0.03 Ω ±0.02% of reading ±40 mK at 30 K ±33 mK at 77 K ±135 mK at 300 K ±370 mK at 800 K	±0.1 Ω ±0.04% of reading ±1 mK at 4.2 K ±88 mK at 77 K ±1.144 K at 300 K
Temperature Accuracy including electronic accuracy, CalCurve and calibrated sensor	±31 mK at 4.2 K ±193 mK at 77 K ±138 mK at 300 K ±177 mK at 475 K	±21 mK at 10 K ±390 mK at 77 K ±140 mK at 300 K ±210 mK at 475 K	±45 mK at 30 K ±38 mK at 77 K ±105 mK at 300 K ±262 mK at 675 K ±287 mK at 800 K	±60 mK at 30 K ±53 mK at 77 K ±170 mK at 300 K ±470 mK at 800 K	±9 mK at 4.2 K‡ ±138 mK at 77 K‡ ±1.284 K at 300 K‡
Magnetic Field Use	Recommended for T ≥ 60 K & B ≤ 3 T	Recommended for T > 4.2 K & B ≤ 5 T	Recommended for T > 40 K & B ≤ 2.5 T	Recommended for T > 40 K & B ≤ 2.5 T	Recommended for T > 2 K & B ≤ 19 T

* No longer available from Lake Shore.

† Typical sensor sensitivities were taken from representative calibrations for the sensor listed.

‡ Specified accuracy includes no effect of thermal EMF voltages. An error of 3 mΩ results from each 1 μV of thermal EMF voltage. In well-designed systems, thermal EMF voltage should be less than 10 μV.

This Page Intentionally Left Blank

CHAPTER 11

SERVICE

11.0 GENERAL

This chapter provides general service information for the Model 340 Temperature Controller. There is no calibration procedure for the Model 340. There are no serviceable parts inside the Model 340. If you have any specific problems with your Model 340, please call Lake Shore.

General maintenance precautions are defined in Paragraph 11.1. Electrostatic discharge is defined in Paragraph 11.2. Changing power settings and fuse rating, removal and replacement is described in Paragraph 11.3. Paragraph 11.4 provides general maintenance information. Rear panel connector definitions are provided in Paragraph 11.5. Serial cable and adapters are described in Paragraph 11.6. A top of enclosure remove and replace procedure is provided in Paragraph 11.7. Software EPROM and Precision Option NOVRAM replacement is detailed in Paragraph 11.8. Error messages are described in Paragraph 11.9. Firmware IC replacement is described in Paragraph 11.10. Finally, updating the master firmware from a data card is described in 11.11.

11.1 GENERAL MAINTENANCE PRECAUTIONS

The following are general safety precautions that are not related to any specific procedure and therefore do not appear elsewhere in this publication. These are recommended precautions that personnel should understand and apply during the maintenance phase.

Keep away from live circuits. Installation personnel shall observe all safety regulations at all times. Turn off system power before making or breaking electrical connections. Regard any exposed connector, terminal board, or circuit board as a possible shock hazard. Components that retain a charge shall be discharged only when such grounding does not result in equipment damage. If a test connection to energized equipment is required, make the test equipment ground connection before probing the voltage or signal to be tested.

Do not install or service equipment alone. Personnel shall not under any circumstances reach into or enter any enclosure for the purpose of servicing or adjusting the equipment without immediate presence or assistance of another person capable of rendering aid.

11.2 ELECTROSTATIC DISCHARGE

Damage can occur to electronic parts, assemblies, and equipment from electrostatic discharge (ESD). ESD is defined as a transfer of electrostatic charge between bodies at different electrostatic potentials caused by direct contact or induced by an electrostatic field. The low-energy source that most commonly destroys Electrostatic discharge Sensitive (ESDS) devices is the human body, which in conjunction with nonconductive garments and floor coverings generates and retains static electricity. Simply walking across a carpet in low humidity can generate up to 35,000 volts of static electricity.

Trends in technology are toward greater complexity, increasing packaging density, and hence thinner dielectrics between active elements, resulting in electronic devices becoming even more sensitive to ESD. Various electronic parts are more ESDS than others. These can be damaged by ESD levels generated by personnel testing, handling, repairing, and assembling electronic components without their being aware that a discharge of static electricity has even occurred. Many ESDS devices such as semiconductors, thick and thin film resistors, chips and hybrid devices, and piezoelectric crystals can be damaged or destroyed by ESD levels of a few hundred volts, which is far below the 4000 volt human threshold of awareness. Discharges below this level cannot be seen, felt or heard.

11.2.1 Identification of Electrostatic Discharge Sensitive Components

The various symbols used in the industry to label components as ESDS are shown as follows:



11.2.2 Handling of Electrostatic Discharge Sensitive Components

In general, all precautions necessary to ensure prevention of damage to ESDS components should be observed before attempting installation. This means that the device and everything that contacts it must be brought to ground potential by providing a conductive surface and discharge paths. As a minimum, the following precautions must be observed:

1. De-energize or disconnect all power and signal sources and loads used with controller.
2. Place controller on a grounded conductive work surface.
3. Ground technician through a conductive wrist strap (or other device) using 1 M Ω series resistor.
4. Ground any tools, such as soldering equipment, that will contact controller. Contact with operator's hands provides a sufficient ground for tools that are otherwise electrically isolated.
5. When ESDS devices and assemblies are not in controller, they must be on a conductive work surface or in a conductive container. When a device or assembly is inserted or removed from a container, operator must maintain contact with conductive portion of container. Only use plastic bags approved for storage of ESDS material.
6. Do not handle ESDS devices unnecessarily or remove them from packaging until actually used or tested.

11.3 Line Input Assembly

This section describes how to properly connect the Model 340 to line power. Please follow these instructions carefully to ensure proper operation of the instrument and the safety of operators.

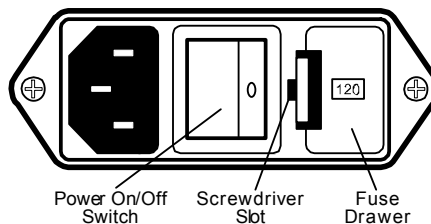

Figure 11-1. Line Input Assembly

Depending upon the date of manufacture, the unit will have either of two fuse data legends printed under the Line Input Assembly:

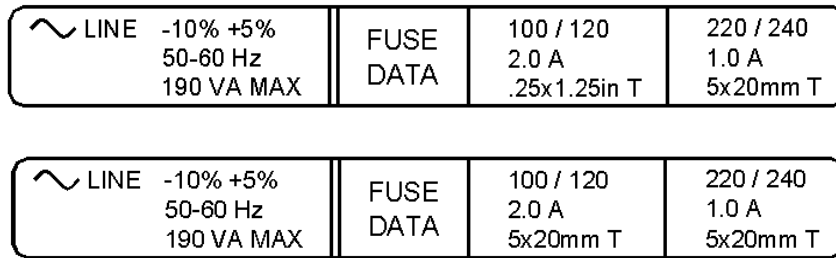

Figure 11-2. Fuse Data Legends

Only the dimensions of the 2 A fuse change; the rating does not.

Line voltage is discussed in Paragraph 11.3.1. Fuse verification is discussed in Paragraph 11.3.2. Line voltage selection is discussed in Paragraph 11.3.3. Fuse removal and replacement is discussed in Paragraph 11.3.4.

11.3.1 Line Voltage

The line input assembly contains the line voltage selector, line fuse holder, and power cord connector. It is important to verify that the Model 340 is set to the appropriate line voltage and has the correct line fuse before it is powered on for the first time. Refer to Table 11-1. If the final destination of the instrument is known when it is shipped, the line input is configured at the factory. This configuration should always be checked because it is not unusual for an instrument to change hands before it reaches the end user. All of the line voltages discussed are single phase.

Table 11-1 AC Line Input Definitions

Indicator	Line Voltage Range	Fuse (slow blow)
100	90-105 VAC	2 A
120	108-126 VAC	2 A
220	198-231 VAC	1 A
240	216-252 VAC	1 A

To verify the proper line voltage selection look at the indicator in the window of the line input assembly. Line voltage should be in the range shown in Table 11-1 for that indicator. If it is not, change the line voltage selector as described in Paragraph 11.3.3.

11.3.2 Fuse Verification

The fuse must be removed to verify its value. Refer to Paragraph 11.3.4 for fuse replacement instructions. Fuses are slow blow (time delay) type and should always be the value specified in Table 11-1. Fuse values are also printed on the rear panel of the instrument for convenience.

WARNING: To avoid potentially lethal shocks, turn off controller and disconnect it from AC power line before performing these procedures. Only qualified personnel should perform these procedures.

CAUTION: For continued protection against fire hazard, replace only with the same type and rating of fuse as specified for the line voltage selected.

11.3.3 Line Voltage Selection

The following is the procedure to change the instrument line voltage selector. Verify the fuse value whenever line voltage is changed.

1. Identify the line input assembly on the instrument rear panel.
2. Turn the line power switch OFF (O).
3. Remove the instrument power cord.
4. With a small screwdriver, release the drawer holding the line voltage selector and fuse.
5. Slide out the removable plastic fuse holder from the drawer.
6. Rotate the fuse holder until the proper voltage indicator shows through the window.
7. Verify the proper fuse value.
8. Re-assemble the line input assembly in the reverse order. Depending upon the date of manufacture, the instrument may use fuses of different physical sizes, as described in Paragraph 11.3. An additional fuse drawer has been supplied in the connector kit if this is the case. Be sure to use the correct fuse drawer for the fuse selected.
9. Verify the voltage indicator in the window of the line input assembly.
10. Connect the instrument power cord.
11. Turn the line power switch ON (I).

11.3.4 Fuse Removal and Replacement

Below is the procedure to remove and replace a line fuse. Use slow blow fuses with the value shown in Table 11-1. To change line input from the factory setting, use the appropriate fuse in the connector kit shipped with the instrument.

1. Locate the line input assembly on the instrument rear panel.
2. Turn the power switch OFF (O).
3. Remove the instrument power cord.
4. With a small screwdriver, release the drawer holding the line voltage selector and fuse.
5. Remove fuse and replace it with the appropriate slow blow fuse.
6. Re-assemble the line input assembly in reverse order.
7. Verify voltage indicator in the line input assembly window.
8. Connect the instrument power cord.
9. Turn the power switch ON (I).

11.4 GENERAL MAINTENANCE

11.4.1 Cleaning

Clean the Model 340 periodically to remove dust, grease and other contaminants. Use the procedure below:

1. Clean front and back panels and case with soft cloth dampened with mild detergent and water solution.

NOTE: Do *not* use aromatic hydrocarbons or chlorinated solvents to clean the Model 340. They may react with the plastic materials used in the controller or the silk screen printing on the back panel.

2. Clean surface of printed circuit boards (PCBs) using clean, dry air at low pressure.

11.5 REAR PANEL CONNECTOR DEFINITIONS

The Serial I/O, Digital I/O, Relays, Analog Outputs, Sensor Inputs, and Heater Output connectors are defined in Figures 11-3 through 11-8 respectively.

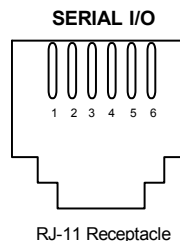

PIN	DESCRIPTION
1	Serial In (RxD)
2	Serial In (RxD)
3	Serial Ground
4	Serial Ground
5	Serial Out (TxD)
6	Serial Out (TxD)

Figure 11-3. SERIAL I/O RJ-11 Rear Panel Connector Details

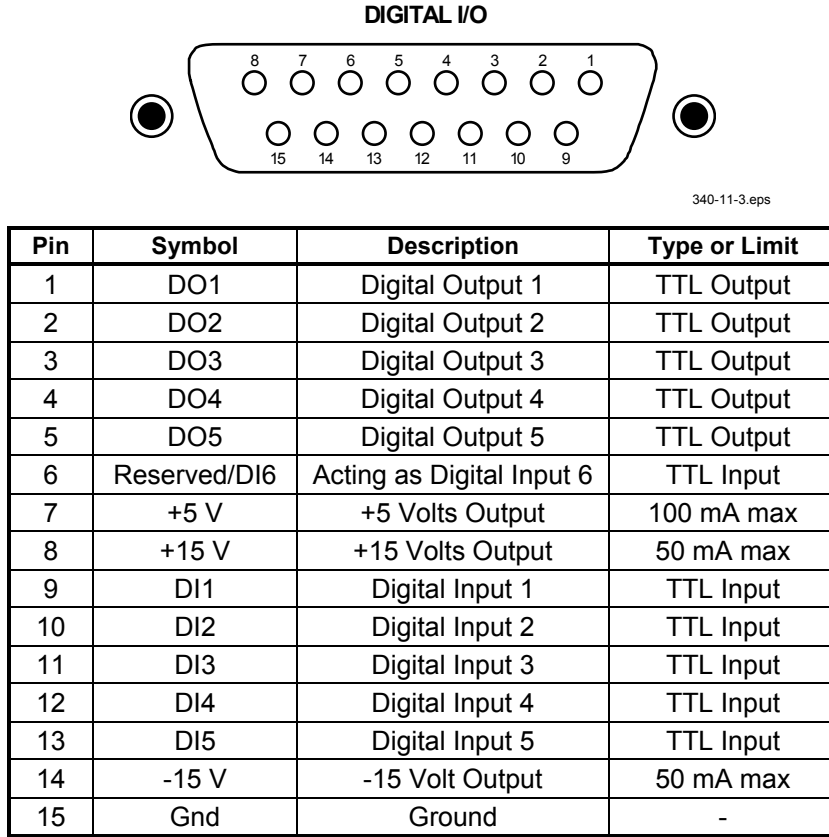
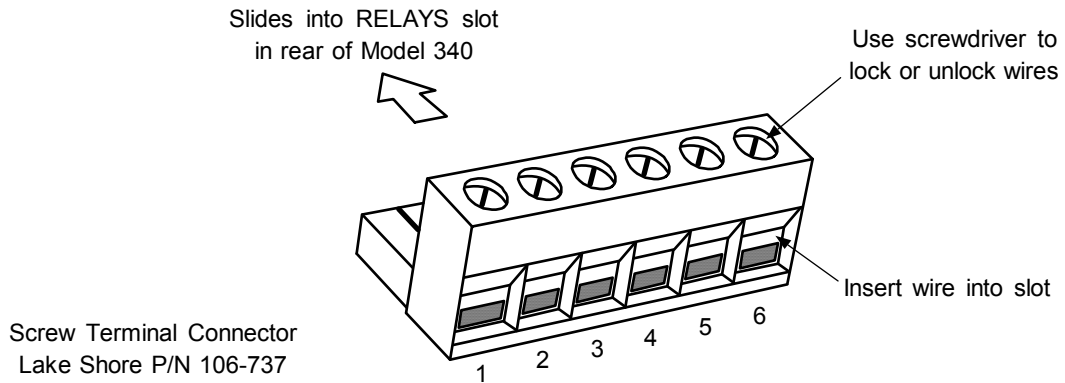
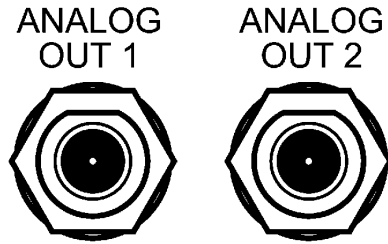

Figure 11-4. DIGITAL I/O DA-15 Rear Panel Connector Details



PIN	DESCRIPTION
1	Low, Normally Closed (N.C.)
2	Low, Common
3	Low, Normally Open (N.O.)
4	High, Normally Closed (N.C.)
5	High, Common
6	High, Normally Open (N.O.)

Figure 11-5. RELAYS LO & HI Rear Panel Connector Details



PIN	DESCRIPTION
1	Analog Output, Center Conductor
2	Ground, Connector Shell

Figure 11-6. ANALOG OUT 1 & 2 BNC Rear Panel Connector Details

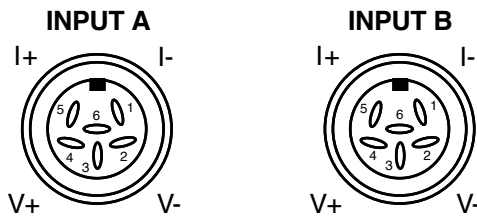

PIN	SYMBOL	DESCRIPTION
1	I-	- Current
2	V-	- Voltage
3	none	Driven Shield or Guard
4	+V	+ Voltage
5	+I	+ Current
6	none	No Connection

Figure 11-7. Sensor INPUT A & B Rear Panel Connector Details

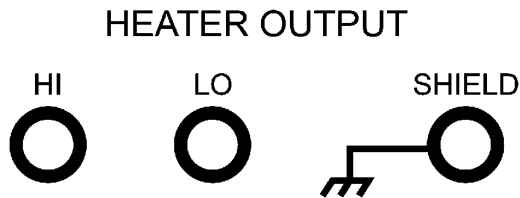

PIN	DESCRIPTION
1	HI
2	LO
3	SHIELD

Figure 11-8. HEATER OUTPUT Rear Panel Connector Details

11.5.1 IEEE-488 Interface Connector

Connection to the IEEE-488 Interface connector on the rear of the Model 340 Temperature Controller is made using cables specified in the IEEE-488-1978 standard document. Briefly, the cable has 24 conductors with an outer shield. The connectors at each end are 24-way Amphenol 57 Series (or equivalent) with piggyback receptacles to allow daisy-chaining in multiple device systems. The connectors are secured in the receptacles by a pair of captive locking screws with metric threads.

The total length of cable allowed in a system is 2 meters for each device on the bus, or 20 meters maximum. This instrument can drive a bus with up to 10 devices. Figure 11-9 shows the IEEE-488 Interface connector pin location and signal names as views from the rear panel of the controller.

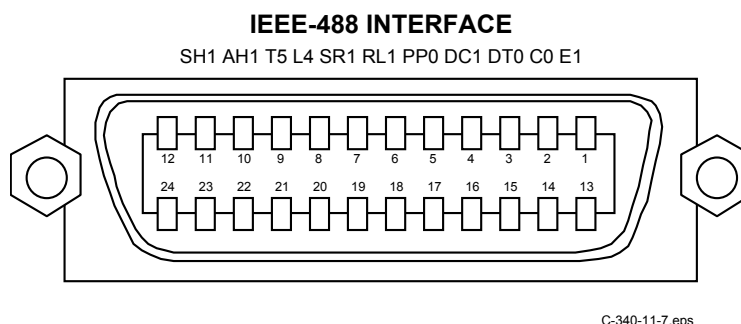

PIN	SYMBOL	DESCRIPTION
1	DIO1	Data Input/Output Line 1
2	DIO2	Data Input/Output Line 2
3	DIO3	Data Input/Output Line 3
4	DIO4	Data Input/Output Line 4
5	EOI	End Or Identify
6	DAV	Data Valid
7	NRFD	Not Ready For Data
8	NDAC	Not Data Accepted
9	IFC	Interface Clear
10	SRQ	Service Request
11	ATN	Attention
12	SHIELD	Cable Shield
13	DIO5	Data Input/Output Line 5
14	DIO6	Data Input/Output Line 6
15	DIO7	Data Input/Output Line 7
16	DIO8	Data Input/Output Line 8
17	REN	Remote Enable
18	GND 6	Ground Wire – Twisted pair with DAV
19	GND 7	Ground Wire – Twisted pair with NRFD
20	GND 8	Ground Wire – Twisted pair with NDAC
21	GND 9	Ground Wire – Twisted pair with IFC
22	GND 10	Ground Wire – Twisted pair with SRQ
23	GND11	Ground Wire – Twisted pair with ATN
24	GND	Logic Ground

Figure 11-9. IEEE-488 Rear Panel Connector Details

11.6 SERIAL INTERFACE CABLE AND ADAPTERS

To aid in Serial Interface troubleshooting, wiring information for the serial cable assembly and the two mating adapters are provided in Figures 11-10 through 11-12. The Model 2001 and 2003 are included with the Model 340. The Model 2002 is an option.

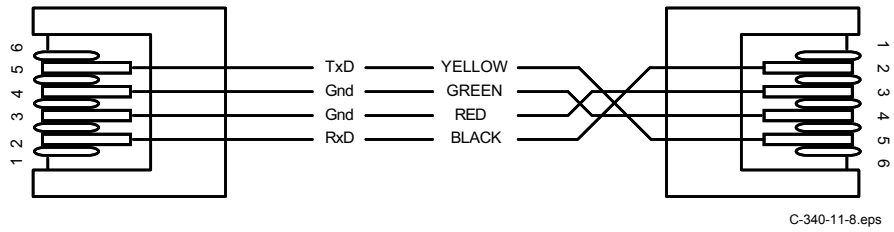

Figure 11-10. Model 2001 RJ-11 Cable Assembly Wiring Details

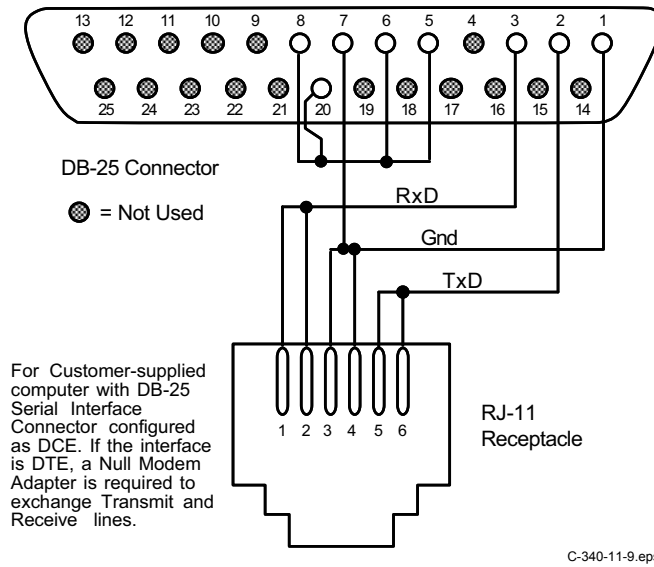

Figure 11-11. Model 2002 RJ-11 to DB-25 Adapter Wiring Details

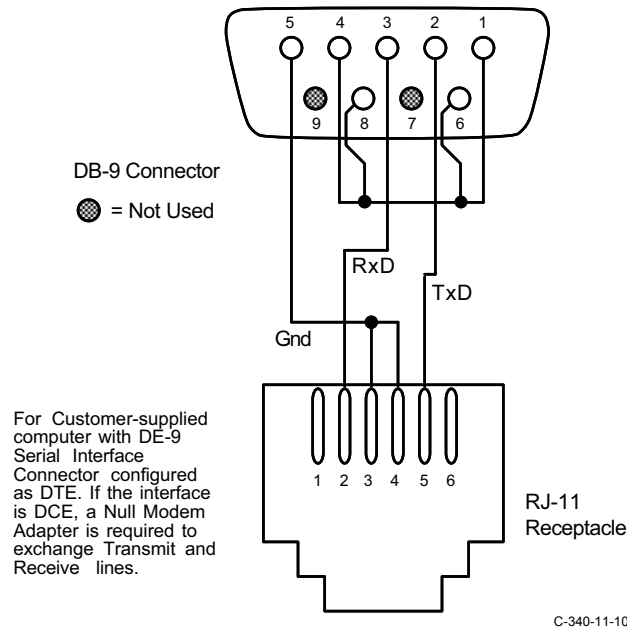

Figure 11-12. Optional Model 2003 RJ-11 to DE-9 Adapter Wiring Details

11.7 TOP OF ENCLOSURE REMOVE AND REPLACE PROCEDURE

WARNING: To avoid potentially lethal shocks, turn off controller and disconnect it from AC power line before performing this procedure. Only qualified personnel should perform this procedure.

REMOVAL

1. Set power switch to Off (O) and disconnect power cord from rear of unit.
2. If attached, remove 19-inch rack mounting brackets.
3. Use a Phillips screwdriver to remove two flat-head screws from center rear top and bottom of enclosure.
4. Use 5/64 hex key to remove four screws attaching top panel to unit.
5. Use 5/64 hex key to loosen four screws attaching bottom panel to unit.
6. Carefully remove the back bezel by sliding it straight back away from the unit.
7. Slide the top panel back and remove it from the unit.

INSTALLATION

1. Slide the top panel forward in the track provided on each side of the unit.
2. Carefully replace the back bezel by sliding it straight into the unit.
3. Use a Phillips screwdriver to install two flat-head screws from center rear top and bottom of enclosure.
4. Use 5/64 hex key to install four screws attaching top panel to unit.
5. Use 5/64 hex key to tighten four screws attaching bottom panel to unit.
6. If required, reattach 19-inch rack mounting brackets.
7. Connect power cord to rear of unit and set power switch to On (I).

11.8 EPROM AND NOVRAM REPLACEMENT

Part of the operating software for the Model 340 is contained on one Erasable Programmable Read Only Memory (EPROM) Integrated Circuit (IC). The reference designator for the EPROM is U146. See Figure 11-13. The EPROM will have a sticker on top with the label SV.HEX and the date. A Non-Volatile Ram Access Memory (NOVRAM) IC (U28) is also included in the Model 340. Please use the following procedure to replace either the EPROM or the NOVRAM.

CAUTION: The EPROM and NOVRAM are Electrostatic Discharge Sensitive (ESDS) devices. Shock-proof wrist straps (resistor limited to <5 mA) must be worn to prevent injury to service personnel and to avoid inducing an Electrostatic Discharge (ESD) into the device.

1. Follow the top of enclosure REMOVAL procedure in Paragraph 11.7.
2. Locate EPROM U146 (M340SV.HEX) or NOVRAM (U28) on the main circuit board. Note orientation of existing IC. See Figure 11-13.
3. Use IC puller to remove existing EPROM/NOVRAM from socket.
4. Noting orientation of new EPROM/NOVRAM, use an IC insertion tool to place new device into socket.

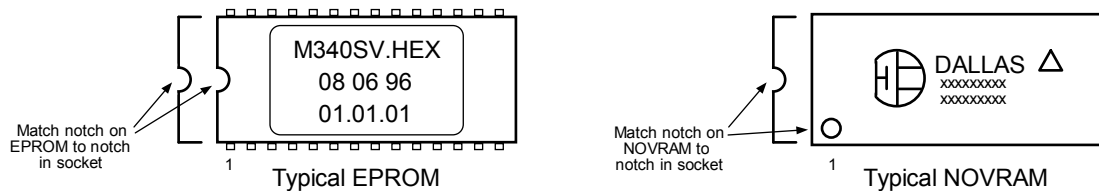

5. Follow the top of enclosure INSTALLATION procedure in Paragraph 11.7.

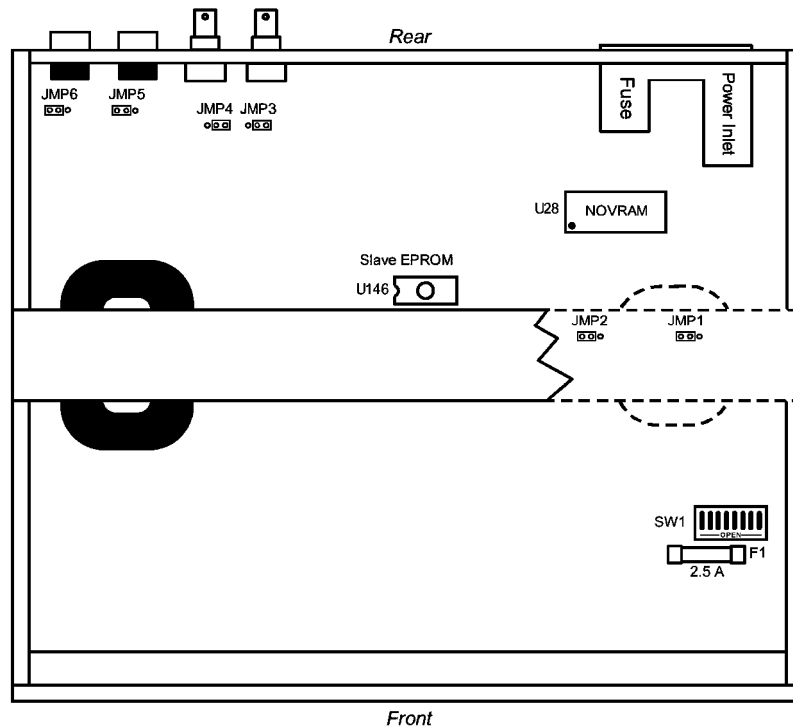

Ground 3	JMP6 []	U80	No Connection	JMP3 []	Analog Output ±10 volts
Ground 3	JMP5 []	U79	Flash	JMP2 []	EPROM
No Connection	JMP4 []	Analog Output ±10 volts	Watch Dog Timer Normal	JMP1 []	Watch Dog Timer Test

Jumpers shown in factory default configuration. Please consult with the factory before changing any jumpers.

Figure 11-13. Location Of Internal Components

11.9 ERROR MESSAGES

Model 340 error messages during normal operation:

- .DISABL. Input is not setup.
- .NOCURV. Input has no curve.
- .S-OVER. Input is at/over full-scale.
- .S-ZERO. Input is zero (does not show up for special or thermocouple sensors).
- .T-OVER. Temperature conversion went off the high end of the curve.
- .T-UNDR. Temperature conversion went off the low end of the curve.

System board error messages:

The slave input processor is not responding.

The curve FLASH chip is not responding.

Flash error code >XXH<[†]

[†] Write down the error code number and call Lake Shore Service.

Heater error messages:

Message	HTRST? Return Value	Description
–	00	No error
Supply Over V	01	Power supply over voltage
Supply Under V	02	Power supply under voltage
Output DAC Error	03	Output digital-to-analog Converter error
ILimit DAC Error	04	Current limit digital-to-analog converter error
Open Heater Load	05	Open heater load*
Load < 10Ω	06	Heater load less than 10 ohms*

* These error messages can be corrected by the user. For all others, contact Lake Shore Service.

11.10 FIRMWARE IC REPLACEMENT

This paragraph contains a procedure to replace the Master Firmware IC (U26) and the Input Firmware IC (U146). An update kit to perform this procedure is available from the Lake Shore Instrument Service Department. The kit includes:

- 32-pin IC – M340MN Flash Memory chip (located at U26).
- 28-pin IC – M340SV EEPROM Memory chip (located at U146).

Required tools:

- Small Standard flat-head screwdriver or pry tool for chip extraction.
- Small Phillips-head screwdriver.
- 5/64-inch Allen wrench.

Before Starting

1. Record the instrument settings. This update requires chip replacement.
2. Stop your application while updating the software. The update process may take as long as ten minutes. Disable the instrument from controlling, digital I/O, and analog outputs.
3. Press the **Options** key, then press the **More** key until the REVISION INFORMATION SCREEN displays the current firmware revision information for both Master and Input processors. If the instrument displays no version numbers, please contact Lake Shore Instrumentation Service Department.

Replacing the Firmware

WARNING: To avoid potentially lethal shocks, turn off controller and disconnect it from AC power before performing these procedures.

1. Turn the Model 340 power switch OFF. Unplug the power cord from the wall outlet, then from the instrument.
2. Stand unit on its face. Use the Allen wrench to remove the 4 screws on each side of the covers.
3. Use the small Phillips screwdriver to remove the top cover screws. Your Model 340 may have 1 or 2 screws on the top cover.
4. Remove the rear plastic bezel. The covers are tracked. Slide the top cover to the rear on the tracks to remove it.
5. Remove four screws attaching the Transformer Assembly to the chassis. Gently lift the assembly and rest it on the chassis at an angle.

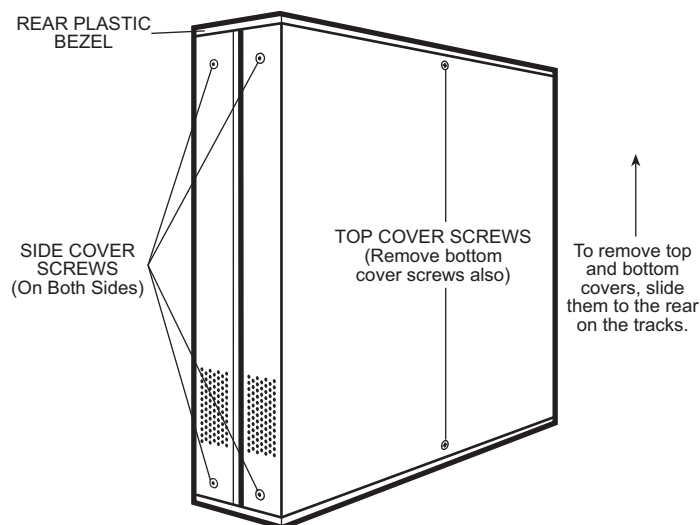

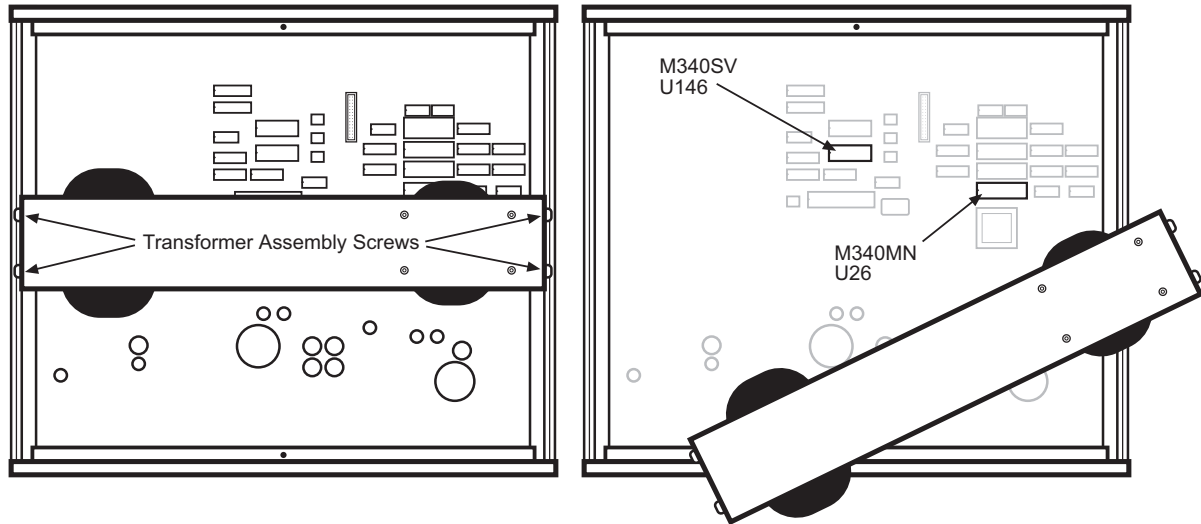

NOTE: If there are only two inputs, then no option card is installed. Proceed to Step 10. If there are more than two inputs, then an Option Card is installed. Perform the actions in Steps 6 through 9.

6. Remove the ribbon cable that plugs into the Option Card plug (J3) located on the lower right corner of the card.
7. Remove the four smaller Phillips head screws that secure the board to the stand-offs. These can be found on the side opposite the sensor plug and on the edge close to the J3 ribbon cable plug.
8. Remove the two Phillips head screws that secure the Option Board to the Model 340 rear panel.
9. The option board now can be lifted out.

CAUTION: The EPROM is an Electrostatic Discharge Sensitive (ESDS) device. Wear shock-proof wrist straps (with a resistor that limits current to <math><5\text{ mA}</math>) to prevent injury to service personnel and to avoid inducing an Electrostatic Discharge (ESD) into the device.

10. Note the orientation of the notch on the M340MN Flash Memory (U26) and M340SV EEPROM Memory (U146) chips. Gently pry the chips from both ends. Once removed, install the new memory chips with the same notch orientation. Press firmly on the center of the chip for good socket connection.
11. Inspect the newly installed chips for bent pins or improper alignment. There should be a pin for every socket hole. Verify the notch orientation.
12. Replace the Option Card (if present). Replace, but do not secure, the cover.
13. Plug in the power cord and turn ON the instrument. If the unit powers up and works normally, the update is successful. Use the options key to check firmware revision information for both Master and Input processors. The REVISION INFORMATION SCREEN shows the current version of the Model 340.
14. If there are any problems, unplug the instrument and open the cover. Inspect the chip pins and notch orientation. Press firmly on the center of the chip to ensure it securely engages the socket. Replace cover and retry. If unsuccessful, contact the Lake Shore Instrumentation Service Department.
15. Upon successful update, power down the instrument, replace the rear plastic bezel, and replace and tighten all cover screws.

11.11 UPDATING THE MASTER FIRMWARE FROM A DATA CARD

This paragraph contains a procedure to update the Master Firmware from a Data Card. The update kit to perform this procedure is available from the Lake Shore Instrument Service Department. The kit includes:

- PCMCIA Data Card containing the latest version of the Master Firmware.

Before You Start

1. Stop your application while updating the software. The update process may take as long as ten minutes. Disable the instrument from controlling, digital I/O, and analog outputs.
2. Press the **Options** key, then press the **More** key until the REVISION INFORMATION SCREEN displays the current firmware revision information for both Master and Input processors. If the instrument displays no version numbers, please contact Lake Shore Instrumentation Service Department.

Loading New Master Firmware from the PCMCIA Data Card

1. Load the PCMCIA data card. The data card slot is on the left bottom corner of the instrument rear. Insert data card with the Lake Shore label face-up. Press firmly on the card until it securely engages the slot.
2. The Data Card key on the right edge of the Model 340 keypad transfers the code from the data card to the flash memory. Press Data card. The display shows 4 choices; highlight Read Data card and press Enter.
3. The display shows the Read Data card options; highlight M340 main code and press Enter. If flash memory is OK, a box appears with the message "Updating code." The system resets itself when load is complete.

This Page Intentionally Left Blank

APPENDIX A

CURVE TABLES

A1.0 GENERAL

Standard curve tables included in the Model 340 Temperature Controller are as follows:

Curve 1	DT-470 Silicon Diode	Table A-1
Curve 2 & 3	DT-500-D/-E1 Silicon Diode.....	Table A-2
Curve 4 & 5	PT-100/-1000 Platinum RTD.....	Table A-3
Curve 6	Type K Thermocouple.....	Table A-4
Curve 7	Type E Thermocouple.....	Table A-5
Curve 8	Type T Thermocouple.....	Table A-6
Curve 9	Chromel-AuFe 0.03% Thermocouple	Table A-7
Curve 10	Chromel-AuFe 0.07% Thermocouple	Table A-8
Curve 11	DT-670 Silicon Diode	Table A-9

Table A-1. Lake Shore DT-470 Standard Curve 10 (Curve 1 in the Model 340)

Break-point	Temp. (K)	Volts	Break-point	Temp. (K)	Volts	Break-point	Temp. (K)	Volts
1	475.0	0.09062	30	170.0	0.82405	59	031.0	1.10476
2	470.0	0.10191	31	160.0	0.84651	60	030.0	1.10702
3	465.0	0.11356	32	150.0	0.86874	61	029.0	1.10945
4	460.0	0.12547	33	145.0	0.87976	62	028.0	1.11212
5	455.0	0.13759	34	140.0	0.89072	63	027.0	1.11517
6	450.0	0.14985	35	135.0	0.90161	64	026.0	1.11896
7	445.0	0.16221	36	130.0	0.91243	65	025.0	1.12463
8	440.0	0.17464	37	125.0	0.92317	66	024.0	1.13598
9	435.0	0.18710	38	120.0	0.93383	67	023.0	1.15558
10	430.0	0.19961	39	115.0	0.94440	68	022.0	1.17705
11	420.0	0.22463	40	110.0	0.95487	69	021.0	1.19645
12	410.0	0.24964	41	105.0	0.96524	70	019.5	1.22321
13	400.0	0.27456	42	100.0	0.97550	71	017.0	1.26685
14	395.0	0.28701	43	095.0	0.98564	72	015.0	1.30404
15	380.0	0.32417	44	090.0	0.99565	73	013.5	1.33438
16	365.0	0.36111	45	085.0	1.00552	74	012.5	1.35642
17	345.0	0.41005	46	080.0	1.01525	75	011.5	1.38012
18	330.0	0.44647	47	075.0	1.02482	76	010.5	1.40605
19	325.0	0.45860	48	070.0	1.03425	77	009.5	1.43474
20	305.0	0.50691	49	065.0	1.04353	78	008.5	1.46684
21	300.0	0.51892	50	058.0	1.05630	79	007.5	1.50258
22	285.0	0.55494	51	052.0	1.06702	80	005.2	1.59075
23	265.0	0.60275	52	046.0	1.07750	81	004.2	1.62622
24	250.0	0.63842	53	040.0	1.08781	82	003.4	1.65156
25	235.0	0.67389	54	039.0	1.08953	83	002.6	1.67398
26	220.0	0.70909	55	036.0	1.09489	84	002.1	1.68585
27	205.0	0.74400	56	034.0	1.09864	85	001.7	1.69367
28	190.0	0.77857	57	033.0	1.10060	86	001.4	1.69818
29	180.0	0.80139	58	032.0	1.10263			

Table A-2. Standard DT-500 Silicon Diode Curves

(Sensors are no longer in production)

Break-point	D Curve (Curve 2)		E1 Curve (Curve 3)	
	Temp. (K)	Volts	Temp. (K)	Volts
1	365.0	0.19083	330.0	0.28930
2	345.0	0.24739	305.0	0.36220
3	305.0	0.36397	285.0	0.41860
4	285.0	0.42019	265.0	0.47220
5	265.0	0.47403	240.0	0.53770
6	240.0	0.53960	220.0	0.59260
7	220.0	0.59455	170.0	0.73440
8	170.0	0.73582	130.0	0.84490
9	130.0	0.84606	100.0	0.92570
10	090.0	0.95327	075.0	0.99110
11	070.0	1.00460	060.0	1.02840
12	055.0	1.04070	040.0	1.07460
13	040.0	1.07460	036.0	1.08480
14	034.0	1.09020	034.0	1.09090
15	032.0	1.09700	032.0	1.09810
16	030.0	1.10580	030.0	1.10800
17	029.0	1.11160	029.0	1.11500
18	028.0	1.11900	028.0	1.12390
19	027.0	1.13080	027.0	1.13650
20	026.0	1.14860	026.0	1.15590
21	025.0	1.17200	025.0	1.18770
22	023.0	1.25070	024.0	1.23570
23	021.0	1.35050	022.0	1.33170
24	017.0	1.63590	018.0	1.65270
25	015.0	1.76100	013.0	1.96320
26	013.0	1.90660	009.0	2.17840
27	009.0	2.11720	004.0	2.53640
28	003.0	2.53660	003.0	2.59940
29	001.4	2.59840	001.4	2.65910

Table A-3. Standard Platinum Curves

Break-point	PT-100 (Curve 4)		PT-1000 (Curve 5)	
	Temp. (K)	Ohms (Ω)	Temp. (K)	Ohms (Ω)
1	030.0	3.820	030.0	38.20
2	032.0	4.235	032.0	42.35
3	036.0	5.146	036.0	51.46
4	038.0	5.650	038.0	56.50
5	040.0	6.170	040.0	61.70
6	042.0	6.726	042.0	67.26
7	046.0	7.909	046.0	79.09
8	052.0	9.924	052.0	99.24
9	058.0	12.180	058.0	121.80
10	065.0	15.015	065.0	150.15
11	075.0	19.223	075.0	192.23
12	085.0	23.525	085.0	235.25
13	105.0	32.081	105.0	320.81
14	140.0	46.648	140.0	466.48
15	180.0	62.980	180.0	629.80
16	210.0	75.044	210.0	750.44
17	270.0	98.784	270.0	987.84
18	315.0	116.270	315.0	1162.70
19	355.0	131.616	355.0	1316.16
20	400.0	148.652	400.0	1486.52
21	445.0	165.466	445.0	1654.66
22	490.0	182.035	490.0	1820.35
23	535.0	198.386	535.0	1983.86
24	585.0	216.256	585.0	2162.56
25	630.0	232.106	630.0	2321.06
26	675.0	247.712	675.0	2477.12
27	715.0	261.391	715.0	2613.91
28	760.0	276.566	760.0	2765.66
29	800.0	289.830	800.0	2898.30

Table A-4. Type K (Nickel-Chromium vs. Nickel-Aluminum) Thermocouple Curve

Break-point	mV	Temp (K)	Break-point	mV	Temp (K)	Break-point	mV	Temp (K)	Break-point	mV	Temp (K)
1	-6.45774	3.15	51	-6.02997	63.5	101	-2.05503	218.5	151	29.0181	970.5
2	-6.45733	3.68	52	-6.00271	65.5	102	-1.87703	223.5	152	29.7714	988.5
3	-6.45688	4.2	53	-5.97469	67.5	103	-1.69672	228.5	153	30.5011	1006
4	-6.45632	4.78	54	-5.94591	69.5	104	-1.51427	233.5	154	31.2074	1023
5	-6.45565	5.4	55	-5.91637	71.5	105	-1.32972	238.5	155	31.8905	1039.5
6	-6.45494	6	56	-5.8861	73.5	106	-1.12444	244	156	32.571	1056
7	-6.4541	6.65	57	-5.85508	75.5	107	-0.91675	249.5	157	33.2489	1072.5
8	-6.4531	7.35	58	-5.82334	77.5	108	-0.70686	255	158	33.9038	1088.5
9	-6.45201	8.05	59	-5.78268	80	109	-0.47553	261	159	34.5561	1104.5
10	-6.45073	8.8	60	-5.74084	82.5	110	-0.22228	267.5	160	35.2059	1120.5
11	-6.44934	9.55	61	-5.69792	85	111	0.053112	274.5	161	35.8532	1136.5
12	-6.44774	10.35	62	-5.6539	87.5	112	0.350783	282	162	36.4979	1152.5
13	-6.44601	11.15	63	-5.60879	90	113	0.651006	289.5	163	37.14	1168.5
14	-6.44403	12	64	-5.5626	92.5	114	0.973714	297.5	164	37.7596	1184
15	-6.44189	12.85	65	-5.51535	95	115	1.31919	306	165	38.3767	1199.5
16	-6.43947	13.75	66	-5.46705	97.5	116	1.70801	315.5	166	38.9915	1215
17	-6.43672	14.7	67	-5.4177	100	117	2.14052	326	167	39.6038	1230.5
18	-6.43378	15.65	68	-5.36731	102.5	118	2.69954	339.5	168	40.2136	1246
19	-6.43065	16.6	69	-5.3159	105	119	3.75883	365	169	40.821	1261.5
20	-6.42714	17.6	70	-5.26348	107.5	120	4.29687	378	170	41.4063	1276.5
21	-6.42321	18.65	71	-5.19928	110.5	121	4.74986	389	171	41.9893	1291.5
22	-6.41905	19.7	72	-5.13359	113.5	122	5.17977	399.5	172	42.5699	1306.5
23	-6.41442	20.8	73	-5.06651	116.5	123	5.60705	410	173	43.1288	1321
24	-6.40952	21.9	74	-4.99801	119.5	124	6.03172	420.5	174	43.6853	1335.5
25	-6.40435	23	75	-4.92813	122.5	125	6.49428	432	175	44.2394	1350
26	-6.39841	24.2	76	-4.85687	125.5	126	7.09465	447	176	44.7721	1364
27	-6.39214	25.4	77	-4.78426	128.5	127	8.15226	473.5	177	45.3024	1378
28	-6.38554	26.6	78	-4.71031	131.5	128	8.75291	488.5	178	45.8114	1391.5
29	-6.37863	27.8	79	-4.63503	134.5	129	9.25576	501	179	46.3182	1405
30	-6.37077	29.1	80	-4.55845	137.5	130	9.74087	513	180	46.8038	1418
31	-6.36253	30.4	81	-4.48056	140.5	131	10.2285	525	181	47.2873	1431
32	-6.35391	31.7	82	-4.38814	144	132	10.7186	537	182	47.7684	1444
33	-6.34422	33.1	83	-4.29393	147.5	133	11.2317	549.5	183	48.2287	1456.5
34	-6.33408	34.5	84	-4.19806	151	134	11.7883	563	184	48.6868	1469
35	-6.3235	35.9	85	-4.10051	154.5	135	12.3888	577.5	185	49.1426	1481.5
36	-6.3117	37.4	86	-4.00133	158	136	13.054	593.5	186	49.5779	1493.5
37	-6.29939	38.9	87	-3.90053	161.5	137	13.7844	611	187	50.0111	1505.5
38	-6.2866	40.4	88	-3.79815	165	138	14.5592	629.5	188	50.442	1517.5
39	-6.27241	42	89	-3.6942	168.5	139	15.3786	649	189	50.8706	1529.5
40	-6.25768	43.6	90	-3.58873	172	140	16.2428	669.5	190	51.2969	1541.5
41	-6.24239	45.2	91	-3.46638	176	141	17.1518	691	191	51.721	1553.5
42	-6.22656	46.8	92	-3.34204	180	142	18.1482	714.5	192	52.1428	1565.5
43	-6.21019	48.4	93	-3.21584	184	143	19.2959	741.5	193	52.5623	1577.5
44	-6.19115	50.2	94	-3.08778	188	144	20.8082	777	194	52.9795	1589.5
45	-6.17142	52	95	-2.95792	192	145	23.1752	832.5	195	53.3945	1601.5
46	-6.15103	53.8	96	-2.82629	196	146	24.5166	864	196	53.8074	1613.5
47	-6.12998	55.6	97	-2.6762	200.5	147	25.6001	889.5	197	54.2182	1625.5
48	-6.10828	57.4	98	-2.52392	205	148	26.5536	912	198	54.6439	1638
49	-6.08343	59.4	99	-2.36961	209.5	149	27.4199	932.5	199	54.8813	1645
50	-6.05645	61.5	100	-2.21329	214	150	28.2413	952			

Table A-5. Type E (Nickel-Chromium vs. Copper-Nickel) Thermocouple Curve

Break-point	mV	Temp (K)	Break-point	mV	Temp (K)	Break-point	mV	Temp (K)
1	-9.834960	3.15	55	-8.713010	77.50	109	0.701295	285.00
2	-9.834220	3.59	56	-8.646710	80.00	110	1.061410	291.00
3	-9.833370	4.04	57	-8.578890	82.50	111	1.424820	297.00
4	-9.832260	4.56	58	-8.509590	85.00	112	1.791560	303.00
5	-9.830920	5.12	59	-8.438800	87.50	113	2.161610	309.00
6	-9.829330	5.72	60	-8.366570	90.00	114	2.534960	315.00
7	-9.827470	6.35	61	-8.292900	92.50	115	2.943070	321.50
8	-9.825370	7.00	62	-8.217810	95.00	116	3.355100	328.00
9	-9.822890	7.70	63	-8.141330	97.50	117	3.770870	334.50
10	-9.820010	8.45	64	-8.047780	100.50	118	4.190420	341.00
11	-9.816880	9.20	65	-7.952190	103.50	119	4.613650	347.50
12	-9.813290	10.00	66	-7.854690	106.50	120	5.040520	354.00
13	-9.809180	10.85	67	-7.755260	109.50	121	5.470960	360.50
14	-9.804510	11.75	68	-7.653960	112.50	122	5.938380	367.50
15	-9.799510	12.65	69	-7.550790	115.50	123	6.409870	374.50
16	-9.793900	13.60	70	-7.445790	118.50	124	6.885210	381.50
17	-9.787610	14.60	71	-7.338970	121.50	125	7.364360	388.50
18	-9.780590	15.65	72	-7.230370	124.50	126	7.881760	396.00
19	-9.773150	16.70	73	-7.120010	127.50	127	8.403380	403.50
20	-9.764910	17.80	74	-6.989110	131.00	128	8.928940	411.00
21	-9.755820	18.95	75	-6.855790	134.50	129	9.493760	419.00
22	-9.746230	20.10	76	-6.720200	138.00	130	10.0629	427.00
23	-9.735700	21.30	77	-6.582330	141.50	131	10.6361	435.00
24	-9.724650	22.50	78	-6.442220	145.00	132	11.2494	443.50
25	-9.713080	23.70	79	-6.299900	148.50	133	11.867	452.00
26	-9.699960	25.00	80	-6.155400	152.00	134	12.5253	461.00
27	-9.686220	26.30	81	-6.008740	155.50	135	13.188	470.00
28	-9.671890	27.60	82	-5.859960	159.00	136	13.892	479.50
29	-9.655790	29.00	83	-5.687430	163.00	137	14.6005	489.00
30	-9.638980	30.40	84	-5.512090	167.00	138	15.3507	499.00
31	-9.621500	31.80	85	-5.334130	171.00	139	16.1432	509.50
32	-9.602020	33.30	86	-5.153520	175.00	140	16.9403	520.00
33	-9.581740	34.80	87	-4.970330	179.00	141	17.7798	531.00
34	-9.560710	36.30	88	-4.784590	183.00	142	18.6624	542.50
35	-9.537440	37.90	89	-4.596330	187.00	143	19.5881	554.50
36	-9.513290	39.50	90	-4.405600	191.00	144	20.5573	567.00
37	-9.486720	41.20	91	-4.212440	195.00	145	21.5702	580.00
38	-9.457560	43.00	92	-3.992330	199.50	146	22.627	593.50
39	-9.427340	44.80	93	-3.769140	204.00	147	23.7279	607.50
40	-9.396080	46.60	94	-3.543070	208.50	148	24.873	622.00
41	-9.363810	48.40	95	-3.314120	213.00	149	26.0623	637.00
42	-9.330540	50.20	96	-3.082340	217.50	150	27.3356	653.00
43	-9.296270	52.00	97	-2.847790	222.00	151	28.6935	670.00
44	-9.257090	54.00	98	-2.610520	226.50	152	30.1761	688.50
45	-9.216690	56.00	99	-2.343820	231.50	153	31.8242	709.00
46	-9.175140	58.00	100	-2.073770	236.50	154	33.7187	732.50
47	-9.132450	60.00	101	-1.800570	241.50	155	36.1028	762.00
48	-9.088620	62.00	102	-1.524210	246.50	156	41.8502	833.00
49	-9.043710	64.00	103	-1.244740	251.50	157	44.2747	863.00
50	-8.997710	66.00	104	-0.962207	256.50	158	46.2907	888.00
51	-8.950650	68.00	105	-0.676647	261.50	159	48.1007	910.50
52	-8.902530	70.00	106	-0.359204	267.00	160	49.8256	932.00
53	-8.840980	72.50	107	-0.009079	273.00	161	51.5056	953.00
54	-8.777760	75.00	108	0.344505	279.00			

Table A-6. Type T (Copper vs. Copper-Nickel) Thermocouple Curve

Break-point	mV	Temp (K)	Break-point	mV	Temp (K)	Break-point	mV	Temp (K)
1	-6.257510	3.15	56	-5.424100	84.00	111	0.623032	289.00
2	-6.257060	3.56	57	-5.380600	86.50	112	0.843856	294.50
3	-6.256520	4.00	58	-5.336260	89.00	113	1.067190	300.00
4	-6.255810	4.50	59	-5.291080	91.50	114	1.293090	305.50
5	-6.254950	5.04	60	-5.245070	94.00	115	1.521570	311.00
6	-6.253920	5.62	61	-5.188800	97.00	116	1.752660	316.50
7	-6.252780	6.20	62	-5.131290	100.00	117	1.986340	322.00
8	-6.251380	6.85	63	-5.072630	103.00	118	2.222600	327.50
9	-6.249730	7.55	64	-5.012780	106.00	119	2.461410	333.00
10	-6.247810	8.30	65	-4.951770	109.00	120	2.702740	338.50
11	-6.245590	9.10	66	-4.889610	112.00	121	2.946550	344.00
12	-6.243040	9.95	67	-4.826300	115.00	122	3.192800	349.50
13	-6.240300	10.80	68	-4.761840	118.00	123	3.441440	355.00
14	-6.237210	11.70	69	-4.696250	121.00	124	3.715300	361.00
15	-6.233710	12.65	70	-4.629530	124.00	125	3.991980	367.00
16	-6.229800	13.65	71	-4.561670	127.00	126	4.271300	373.00
17	-6.225630	14.65	72	-4.492700	130.00	127	4.553250	379.00
18	-6.221000	15.70	73	-4.422610	133.00	128	4.837770	385.00
19	-6.215860	16.80	74	-4.351390	136.00	129	5.148790	391.50
20	-6.210430	17.90	75	-4.266950	139.50	130	5.462770	398.00
21	-6.204430	19.05	76	-4.180930	143.00	131	5.779560	404.50
22	-6.198680	20.10	77	-4.093440	146.50	132	6.099160	411.00
23	-6.191780	21.30	78	-4.004430	150.00	133	6.421500	417.50
24	-6.184530	22.50	79	-3.913940	153.50	134	6.746540	424.00
25	-6.176930	23.70	80	-3.821970	157.00	135	7.099510	431.00
26	-6.168310	25.00	81	-3.728520	160.50	136	7.455590	438.00
27	-6.159280	26.30	82	-3.633620	164.00	137	7.814630	445.00
28	-6.149830	27.60	83	-3.537260	167.50	138	8.176630	452.00
29	-6.139220	29.00	84	-3.439460	171.00	139	8.541540	459.00
30	-6.128130	30.40	85	-3.340240	174.50	140	8.909320	466.00
31	-6.116580	31.80	86	-3.239610	178.00	141	9.306450	473.50
32	-6.103700	33.30	87	-3.122930	182.00	142	9.706830	481.00
33	-6.090300	34.80	88	-3.004370	186.00	143	10.1103	488.50
34	-6.075460	36.40	89	-2.884040	190.00	144	10.5169	496.00
35	-6.060040	38.00	90	-2.761910	194.00	145	10.9264	503.50
36	-6.044070	39.60	91	-2.638010	198.00	146	11.3664	511.50
37	-6.025470	41.40	92	-2.512340	202.00	147	11.8098	519.50
38	-6.006200	43.20	93	-2.384920	206.00	148	12.2564	527.50
39	-5.986280	45.00	94	-2.255770	210.00	149	12.7342	536.00
40	-5.965730	46.80	95	-2.124900	214.00	150	13.2155	544.50
41	-5.942210	48.80	96	-1.992320	218.00	151	13.7	553.00
42	-5.917930	50.80	97	-1.858060	222.00	152	14.1879	561.50
43	-5.892970	52.80	98	-1.705090	226.50	153	14.7079	570.50
44	-5.864730	55.00	99	-1.549970	231.00	154	15.2314	579.50
45	-5.835680	57.20	100	-1.392820	235.50	155	15.7583	588.50
46	-5.805860	59.40	101	-1.233640	240.00	156	16.2887	597.50
47	-5.776670	61.50	102	-1.072450	244.50	157	16.8224	606.50
48	-5.741100	64.00	103	-0.909257	249.00	158	17.3594	615.50
49	-5.704560	66.50	104	-0.744065	253.50	159	17.9297	625.00
50	-5.667130	69.00	105	-0.576893	258.00	160	18.5037	634.50
51	-5.628800	71.50	106	-0.407776	262.50	161	19.1116	644.50
52	-5.589590	74.00	107	-0.217705	267.50	162	19.7538	655.00
53	-5.549510	76.50	108	-0.025325	272.50	163	20.4611	666.50
54	-5.508560	79.00	109	0.188573	278.00	164	20.8627	673.00
55	-5.466760	81.50	110	0.404639	283.50			

Table A-7. Chromel-AuFe0.03% Thermocouple Curve *

Breakpoint	mV	Temp (K)	Breakpoint	mV	Temp (K)
1	-4.6667	3.5	32	-2.24537	160
2	-4.62838	6.35	33	-2.06041	170
3	-4.60347	8.15	34	-1.86182	180.5
4	-4.58043	9.75	35	-1.66004	191
5	-4.53965	12.5	36	-1.47556	200.5
6	-4.47226	16.95	37	-1.0904	220
7	-4.43743	19.3	38	-0.73397	237.5
8	-4.39529	22.2	39	-0.68333	240
9	-4.34147	26	40	-0.3517	256
10	-4.29859	29.1	41	-0.2385	261.5
11	-4.26887	31.3	42	0.078749	277
12	-4.22608	34.5	43	0.139668	280
13	-4.2018	36.3	44	0.426646	294.5
14	-4.02151	49.8	45	0.546628	300.5
15	-3.94549	55.4	46	0.858608	316
16	-3.87498	60.5	47	0.938667	320
17	-3.80464	65.5	48	1.3456	340
18	-3.73301	70.5	49	1.7279	358.5
19	-3.65274	76	50	1.76905	360.5
20	-3.5937	80	51	2.20705	381.5
21	-3.51113	85.5	52	2.51124	396
22	-3.45023	89.5	53	2.69878	405
23	-3.43451	90.5	54	2.94808	417
24	-3.37842	94	55	3.13562	426
25	-3.35469	95.5	56	3.43707	440.5
26	-3.28237	100	57	3.85513	460.5
27	-3.11919	110	58	4.17136	475.5
28	-2.95269	120	59	4.28662	481
29	-2.78168	130	60	4.64037	498
30	-2.60639	140	61	4.68168	500
31	-2.42737	150			

* This thermocouple is no longer sold by Lake Shore.

Table A-8. Chromel-AuFe0.07% Thermocouple Curve

Break-point	mV	Temp (K)	Break-point	mV	Temp (K)	Break-point	mV	Temp (K)
1	-5.279520	3.15	35	-3.340820	115.00	69	1.313400	332.50
2	-5.272030	3.78	36	-3.253410	119.50	70	1.511140	341.50
3	-5.263500	4.46	37	-3.165360	124.00	71	1.709250	350.50
4	-5.253730	5.20	38	-3.076690	128.50	72	1.928940	360.50
5	-5.242690	6.00	39	-2.977480	133.50	73	2.127070	369.50
6	-5.229730	6.90	40	-2.877550	138.50	74	2.324710	378.50
7	-5.214770	7.90	41	-2.776950	143.50	75	2.523070	387.50
8	-5.196980	9.05	42	-2.675700	148.50	76	2.643480	393.00
9	-5.176250	10.35	43	-2.563610	154.00	77	2.708890	396.00
10	-5.150910	11.90	44	-2.450770	159.50	78	2.764030	398.50
11	-5.116700	13.95	45	-2.337230	165.00	79	2.797580	400.00
12	-5.049770	17.90	46	-2.223010	170.50	80	2.950200	406.50
13	-5.002120	20.70	47	-2.097700	176.50	81	3.008310	409.00
14	-4.938000	24.50	48	-1.971630	182.50	82	3.031200	410.00
15	-4.876180	28.20	49	-1.844890	188.50	83	3.218040	418.00
16	-4.801670	32.70	50	-1.706840	195.00	84	3.300110	421.50
17	-4.648620	42.00	51	-1.568040	201.50	85	4.000810	451.50
18	-4.569170	46.80	52	-1.428520	208.00	86	4.246390	462.00
19	-4.499080	51.00	53	-1.277520	215.00	87	4.701810	481.50
20	-4.435090	54.80	54	-1.114900	222.50	88	4.947390	492.00
21	-4.370520	58.60	55	-0.940599	230.50	89	5.636410	521.50
22	-4.303610	62.50	56	-0.754604	239.00	90	5.870300	531.50
23	-4.234290	66.50	57	-0.556906	248.00	91	6.547630	560.50
24	-4.164270	70.50	58	-0.358437	257.00	92	6.711600	567.50
25	-4.093560	74.50	59	-0.170179	265.50	93	6.781410	570.50
26	-4.022170	78.50	60	0.041150	275.00	94	6.931500	577.00
27	-3.950100	82.50	61	0.152699	280.00	95	7.001360	580.00
28	-3.877360	86.50	62	0.163149	280.50	96	7.166710	587.00
29	-3.803960	90.50	63	0.374937	290.00	97	7.260420	591.00
30	-3.729910	94.50	64	0.542973	297.50	98	7.412010	597.50
31	-3.655230	98.50	65	0.598604	300.00	99	7.529070	602.50
32	-3.579930	102.50	66	0.774384	308.00	100	7.657460	608.00
33	-3.504020	106.50	67	0.840638	311.00	101	7.704410	610.00
34	-3.427530	110.50	68	1.126350	324.00			

Table A-9. Standard DT-670 Diode Curve

Breakpoint	V	Temp. (K)	Breakpoint	V	Temp. (K)	Breakpoint	V	Temp. (K)
1	0.090570	500.0	26	1.01064	87.0	51	1.19475	20.2
2	0.110239	491.0	27	1.02125	81.0	52	1.24208	17.10
3	0.136555	479.5	28	1.03167	75.0	53	1.26122	15.90
4	0.179181	461.5	29	1.04189	69.0	54	1.27811	14.90
5	0.265393	425.5	30	1.05192	63.0	55	1.29430	14.00
6	0.349522	390.0	31	1.06277	56.4	56	1.31070	13.15
7	0.452797	346.0	32	1.07472	49.0	57	1.32727	12.35
8	0.513393	320.0	33	1.09110	38.7	58	1.34506	11.55
9	0.563128	298.5	34	1.09602	35.7	59	1.36423	10.75
10	0.607845	279.0	35	1.10014	33.3	60	1.38361	10.00
11	0.648723	261.0	36	1.10393	31.2	61	1.40454	9.25
12	0.686936	244.0	37	1.10702	29.6	62	1.42732	8.50
13	0.722511	228.0	38	1.10974	28.3	63	1.45206	7.75
14	0.755487	213.0	39	1.11204	27.3	64	1.48578	6.80
15	0.786992	198.5	40	1.11414	26.5	65	1.53523	5.46
16	0.817025	184.5	41	1.11628	25.8	66	1.56684	4.56
17	0.844538	171.5	42	1.11853	25.2	67	1.58358	4.04
18	0.869583	159.5	43	1.12090	24.7	68	1.59690	3.58
19	0.893230	148.0	44	1.12340	24.3	69	1.60756	3.18
20	0.914469	137.5	45	1.12589	24.0	70	1.62125	2.62
21	0.934356	127.5	46	1.12913	23.7	71	1.62945	2.26
22	0.952903	118.0	47	1.13494	23.3	72	1.63516	1.98
23	0.970134	109.0	48	1.14495	22.8	73	1.63943	1.74
24	0.986073	100.5	49	1.16297	22.0	74	1.64261	1.53
25	0.998925	93.5	50	1.17651	21.3	75	1.64430	1.40