

**MODEL 808/847 UNIVERSAL PID PROGRAMMER/CONTROLLER
 MODEL 809/849 THREE-STATE VALVE POSITIONER
 PROGRAMMER/CONTROLLER**

Contents page

Chapter 1	SAFETY, EMC AND GENERAL INFORMATION	
	Safety	1-1
	Electromagnetic compatibility.....	1-1
	GENERAL	1-1
	Unpacking and storage	1-1
	General description	1-1
	SERVICE AND REPAIR.	1-2
	Cleaning.	1-2
	INSTALLATION SAFETY REQUIREMENTS.	1-3
	Safety symbols.	1-3
	Personnel	1-3
	Enclosure of live parts	1-3
	Wiring.	1-3
	Power isolation	1-3
	Earth leakage current.	1-4
	Overcurrent protection.....	1-4
	Voltage rating	1-4
	Conductive pollution	1-4
	Over-temperature protection	1-4
	Grounding of the temperature sensor shield . .	1-5
	INSTALLATION REQUIREMENTS FOR EMC ...	1-5
	Routing of wires.	1-5
Chapter 2	INSTALLATION	
	Dimensions and panel mounting	2-1
	Electrical connections.	2-2
	Connecting terminals.	2-3
	Mains supply and earth	2-3
	Output 1.	2-4
	Output 2.	2-4
	Output 3, Alarm	2-7
	Input.	2-7
	Thermocouple input.	2-7

Resistance thermometer (RTD) Pt1 00, three-wire device.	2-8
Linear input (Option QLS...)	2-8
Digital communications (option)	2-9
Programmer/controller (option QP...), setpoint programming option.	2-1 1

Chapter 3 TECHNICAL SPECIFICATION

Chapter 4 PRODUCT CODE

Chapter 5 OPERATION

Operating structure	5-1
Operating modes	5-2
Control algorithms.	5-2
Front panel identification	5-3
Operating procedures	5-5
Alarms	5-7
Sensor break.	5-8
Self-test.	5-8

Chapter 6 CONFIGURATION LEVEL, OPERATOR LEVEL

Configuration link/switch	6-1
Hardware configuration	6-2
Parameter list	6-3
Pre-configuration, parameter setting	6-10
Cutback	6-10

Chapter 7 PARAMETER ACCESS AND CALIBRATION

Parameter access protection.	7-1
Calibration	7-2

Chapter 8 PROGRAMMER/CONTROLLER

Programmer/controller - Function.	8-1
Programmer/controller - States.	8-2
Programmer/controller - Holdback.	8-3
Programmer/controller - Setpoint programming	8-4
Programmer/controller - Annunciators	8-5
Programmer/controller - Parameter modification	8-5
Ending a program.	8-6
Program recovery following loss of power.	8-7

Chapter 9	SELF-TUNING	
	Self-tuning - General.	9-1
	Self-tuning - Activation.	9-2
	Self-tuning - Operation	9-2
	Self-tuning - Abort conditions.	9-7
Chapter 10	INSTRUMENT REGISTER	
Chapter 11	SUPPLEMENTS- Relating to 808/809 valve positioner controllers	
	Valve positioner controller (motor open/close) 1 1 - 1	
	Additional parameters for valve positioner controller . . ,	11-2
	Self-tuning for valve positioner controller . . .	11-2

SAFETY, EMC AND GENERAL INFORMATION

Please read this section carefully before installing the controller

This controller is intended for industrial temperature and process control applications when it will meet the requirements of the European Directives on Safety and EMC. Use in other applications, or failure to observe the installation instructions of this handbook may impair the safety or EMC protection provided by the controller. It is the responsibility of the installer to ensure the safety and EMC of any particular installation.

Safety

This controller complies with the European Low Voltage Directive 73/23/EEC, amended by 93/68/EEC, by the application of the safety standard EN 61010.

Electromagnetic compatibility

This controller conforms with the essential protection requirements of the EMC Directive 89/336/EEC, amended by 93/68/EEC, by the application of a Technical Construction File. This instrument satisfies the general requirements of an industrial environment as described by EN 50081-2 and EN 50082-2. For more information on product compliance refer to the Technical Construction File.

GENERAL

The information contained in this manual is subject to change without notice. While every effort has been made to ensure the accuracy of the information, Eurotherm Controls shall not be held liable for errors contained herein.

Unpacking and storage

If on receipt, the packaging or the instrument are damaged in any way, do not install or commission the product. Contact your nearest Eurotherm Controls agent as soon as possible. If the instrument is to be stored before use, protect from humidity and dust in an ambient temperature range of -30°C to +75 deg C.

The packaging should contain an instrument mounted in its sleeve, two mounting brackets for panel installation and this operating book. Certain ranges are supplied with an input adapter.

General description

Models 808 and 847 are digital temperature controllers. The 809 and 849 are valve positioning controllers. The 808 and 809 are mounted upright, (vertical) and the 847 and 849 are mounted **on** their side (horizontal).

Two LED displays indicate the operating parameters. The top display indicates the actual value, (PV) and the lower display indicates the setpoint, (SP). Other LED beacons indicate the mode of operation, (see Chapter 5, Operation).

Parameters and configuration values are set by use of the front panel keys. The PAR button selects the parameter and the up and down arrows are used to alter their value. In configuration mode each parameter can be defined as 'read only', 'read / write' or 'hidden'. The controller can be switched directly from automatic (closed loop) operation to manual by means of the A/M button.

Without change of the hardware the main process variable input of the instrument can be configured to suit various thermocouples and resistance thermometers, (Pt100). Recalibration is not necessary for this procedure. Signals up to 25V can be accommodated by using input adapters in the linear input option. Linearisation is scaleable within the display range of -999 to 9999, with tenths display resolution.

The controller is also equipped with a ramp to setpoint function. This enables it to automatically adjust the setpoint to give a defined rate of change of the process temperature. In the programmer version, two ramps and two dwell periods may be set.

The modular construction of the instruments allows up to three output channels to perform various functions. The instrument can be configured as a heat cool controller with one alarm, or a heat only controller with two alarms. The heat output may be fitted with a dc output. For communications with a host computer system the instrument can be fitted with either an EIA 232 or EIA 422 digital interface. This enables the automatic recording of measured values on a printer, or the use of a proprietary supervisory system such as Eurotherm Controls ESP package.

SERVICE AND REPAIR

This controller has no user serviceable parts. Contact your nearest Eurotherm Controls agent for repair.

Caution: Charged capacitors

Before removing an instrument from its sleeve, disconnect the supply and wait at least two minutes to allow capacitors to discharge. Failure to observe this precaution will expose capacitors that may be charged with hazardous voltages. In any case, avoid touching the exposed electronics of an instrument when withdrawing it from the sleeve.

Electrostatic discharge precautions

When the controller is removed from its sleeve, some of the exposed electronic components are vulnerable to damage by electrostatic discharge from someone handling the controller. To avoid this, before handling the unplugged controller discharge yourself to ground.

Cleaning

Clean the instrument sleeve and the front fascia with an anti-static cleaner and a soft cloth. Do not use water or water based products to clean labels or they will become illegible. Isopropyl alcohol may be used to clean labels.

INSTALLATION SAFETY REQUIREMENTS

Safety Symbols

Various symbols are used on the instrument, they have the following meaning:



Caution, (refer to the accompanying documents)



Functional earth (ground) terminal

The functional earth connection is not required for safety purposes but to ground RFI filters.

Personnel

Installation must only be carried out by qualified personnel,

Enclosure of live parts

To prevent hands or metal tools touching parts that may be electrically live, the controller must be installed in an enclosure. It is recommended that you use the rear terminal cover provided.

Caution: Live sensors

The fixed digital input and the non-isolated dc and logic outputs, are all electrically connected to the main process variable input. If the temperature sensor is connected directly to an electrical heating element then these non-isolated inputs and outputs will also be live. The controller is designed to operate under these conditions. However you must ensure that this will not damage other equipment connected to these inputs and outputs and that service personnel do not touch connections to these i/o while they are live. With a live sensor, all cables, connectors and switches for connecting the sensor and non-isolated inputs and outputs must be mains rated.

Wiring

It is important to connect the controller in accordance with the wiring data given in this handbook.

- Take particular care not to connect AC supplies to the low voltage sensor input or other low level inputs and outputs.
- Only use copper conductors for wiring connections, (except for thermocouple inputs).
- Ensure that the wiring of installations comply with all local wiring regulations. In the UK use the latest version of the IEE wiring regulations, (BS 767 1). In the USA use NEC Class 1 wiring methods.
 - Unused terminals should not be used as 'tie points'.
- Ensure the correct polarity of signal connections.

Power Isolation

The installation must include a power isolating switch or circuit breaker. This device should be in close proximity to the controller, within easy reach of the operator and marked as the disconnecting device for the instrument.

Earth leakage current

Due to RFI Filtering there is an earth leakage current of less than 0.5mA This may affect the design of an installation of multiple controllers protected by Residual Current Device, (RCD) or Ground Fault Detector, (GFD) type circuit breakers.

Overcurrent protection

To protect wiring and the PCB tracking within the controller against excess currents, the AC power supply to the controller and power outputs must be wired through the fuse or circuit breaker specified in the technical specification.

Voltage rating

The maximum continuous voltage applied between any of the following terminals must not exceed 264Vac:

- line or neutral to any other connection;
- relay or triac output to logic, dc or sensor connections;
- any connection to ground.

The controller should not be wired to a three phase supply with an unearthed star connection. Under fault conditions such a supply could rise above 264Vac with respect to ground and the product would not be safe.

Voltage transients across the power supply connections, and between the power supply and ground, must not exceed 2.5kV. Where occasional voltage transients over 2.5kV are expected or measured, the power installation to both the instrument supply and load circuits should include a transient limiting device.

These units will typically include gas discharge tubes and metal oxide varistors that limit and control voltage transients on the supply line due to lightning strikes or inductive load switching. Devices are available in a range of energy ratings and should be selected to suit conditions at the installation.

Conductive pollution

Electrically conductive pollution must be excluded from the cabinet in which the controller is mounted. For example, carbon dust is a form of electrically conductive pollution. To secure a suitable atmosphere in conditions of conductive pollution, fit an air filter to the air intake of the cabinet. Where condensation is likely, for example at low temperatures, include a thermostatically controlled heater in the cabinet.

Over-temperature protection

When designing any control system it is essential to consider what will happen if any part of the system should fail. In temperature control applications the primary danger is that the heating will remain constantly on. Apart from spoiling the product, this could damage any process machinery being controlled, or even cause a fire.

Reasons why the heating might remain constantly on include:

- the temperature sensor becoming detached from the process;
- thermocouple wiring becoming short circuit;
- the controller failing with its heating output constantly on;

- an external valve or contactor sticking in the heating condition;
- the controller setpoint set too high.

Where damage or injury is possible, we recommend fitting a separate over-temperature protection unit, with an independent temperature sensor, which will isolate the heating circuit. Please note that the alarm relays within the controller will not give protection under all failure conditions.

Grounding of the temperature sensor shield

In some installations it is common practice to replace the temperature sensor while the controller is still powered up. Under these conditions, as additional protection against electric shock, we recommend that the shield of the temperature sensor is grounded. Do not rely on grounding through the framework of the machine.

INSTALLATION REQUIREMENTS FOR EMC

To ensure compliance with the European EMC directive certain installation precautions are necessary as follows:

- For general guidance refer to Eurotherm Controls EMC Installation Guide, HA025464.
- When using relay or triac outputs it may be necessary to fit a filter suitable for suppressing the emissions. The filter requirements will depend on the type of load. For typical applications we recommend Schaffner FN321 or FN612.
- If the unit is used in table top equipment that is plugged into a standard power socket, then it is likely that compliance to the commercial and light industrial emissions standard is required. In this case to meet the conducted emissions requirement, a suitable mains filter should be installed. We recommend Schaffner types FN321 and FN612.

Routing of wires

To minimise the pick-up of electrical noise, the wiring for low voltage dc and particularly the sensor input should be routed away from high-current power cables. Where it is impractical to do this, use shielded cables with the shield grounded at both ends. In general keep cable lengths to a minimum.

INSTALLATION

Before installing this product read the safety and EMC information

Dimensions and panel mounting

The instrument is intended to be mounted into a front panel cut-out. Figure 2.1.1 shows the dimensions of the instrument and of the necessary front panel cut-out with tolerances. Behind the instrument sufficient space should be provided for wiring.

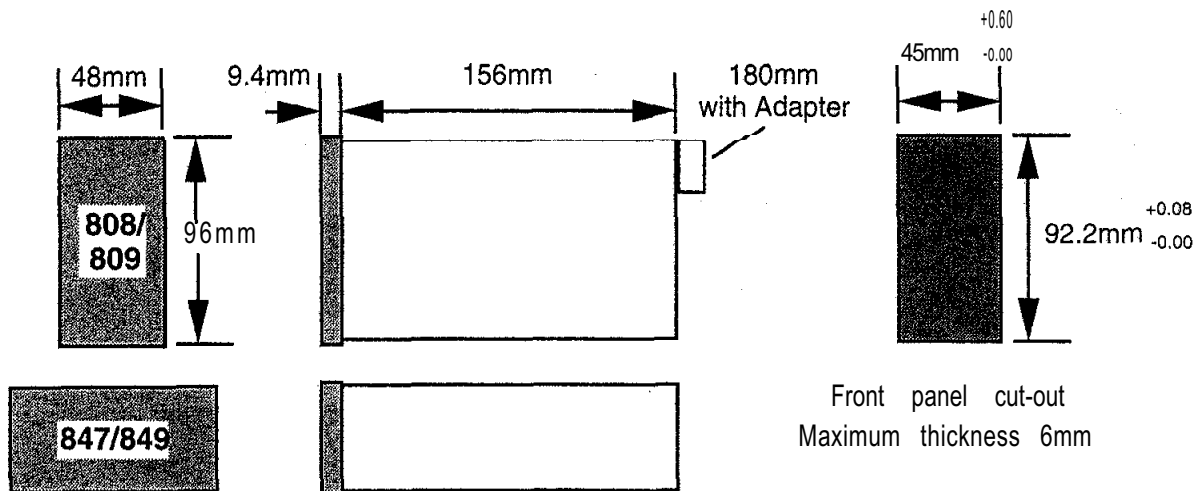

Figure 2.1.1 Dimensions and panel cut-out

Ventilation: The space behind the control panel must be sufficient to allow suitable ventilation to keep the ambient temperature within the permitted range.

To assemble, turn the screw on the front fascia in an anti-clockwise direction and pull the instrument out of the sleeve. Now slide the plug-in sleeve into the control panel cut-out from the front. The two mounting brackets are fastened on the left and right hand side behind the control panel and tightened with a screwdriver in a clockwise direction. A torque limiter prevents over-tightening.

For multiple installation in a control panel, the minimum spacings specified in Figure 2.1.2 must be respected for adequate cooling.

In order to install the instrument to meet the NEMA3 rating (IEC IP54), an additional gasket kit is necessary. The kit consists of two self-adhesive neoprene gasket rings, these seal the instrument to the instrument sleeve, and the sleeve to the front panel. The order number for the gasket kit is LA022339.

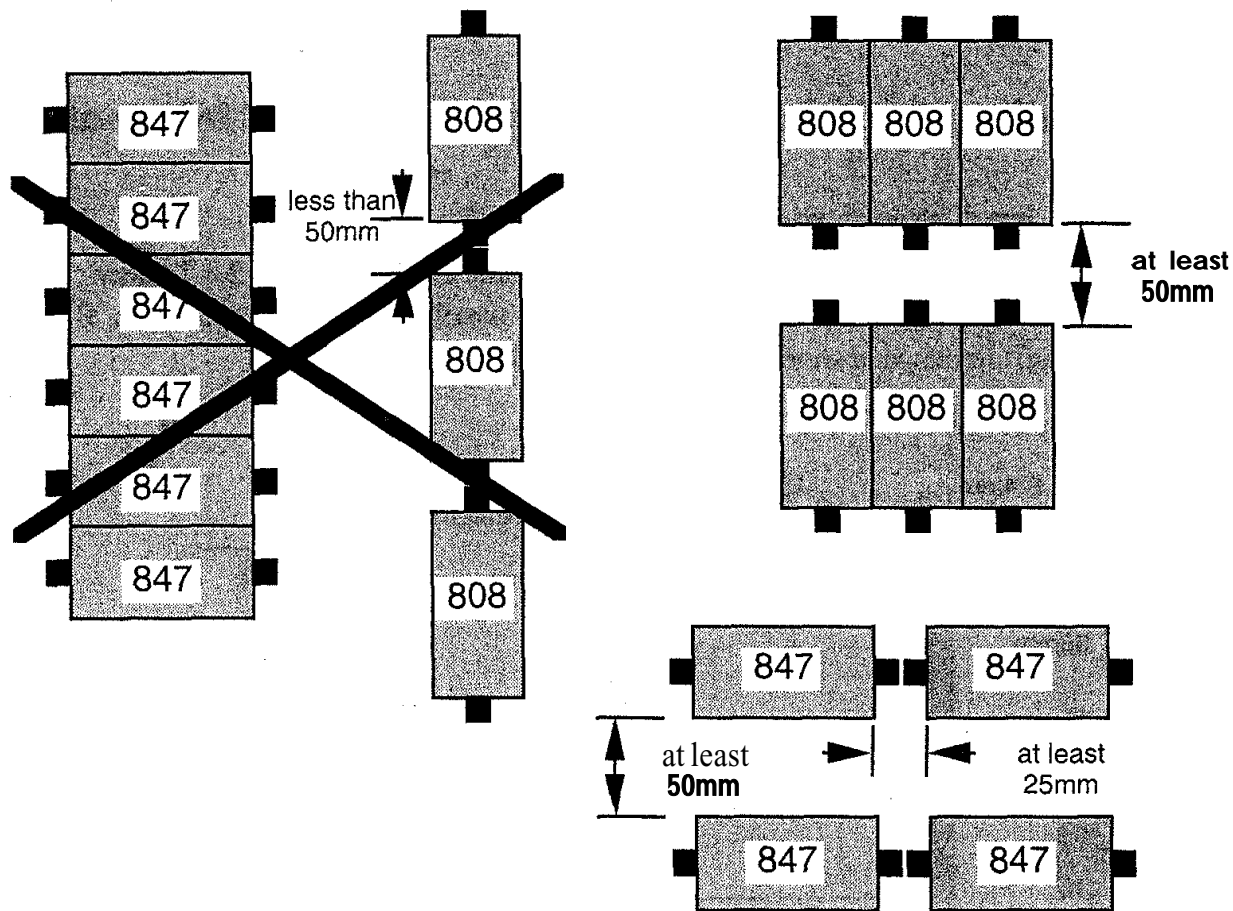

Figure 2.1.2 Minimum spacings for multiple installation

Electrical connections

When wiring electrical equipment, please refer to the instructions in Chapter 1, Safety, EMC and General Information and Chapter 3 Technical Specification.

Before wiring, verify from the instrument label (on the side) which options have been built into the instrument and how the instrument is configured.

The terminals at the rear of the instrument are numbered from 1 to 20. Terminal allocation is shown in Figure 2.2.1.

WARNING

The instrument has no in-built mains switch and is therefore powered when the supply voltage is applied.

Note: Each output fitted with a relay or triac is equipped with an RC suppressor (snubber). Even when the output triac or relay is off, the snubber passes a current of 1mA when connected in a 120V AC circuit and likewise 2mA in a 240V AC circuit. When testing one of these outputs with a high input impedance voltmeter and the output is unloaded, the voltmeter

will read the line voltage even though the output is off. This does not indicate that the output is faulty. Such a test should only be carried out when the output is loaded appropriately.

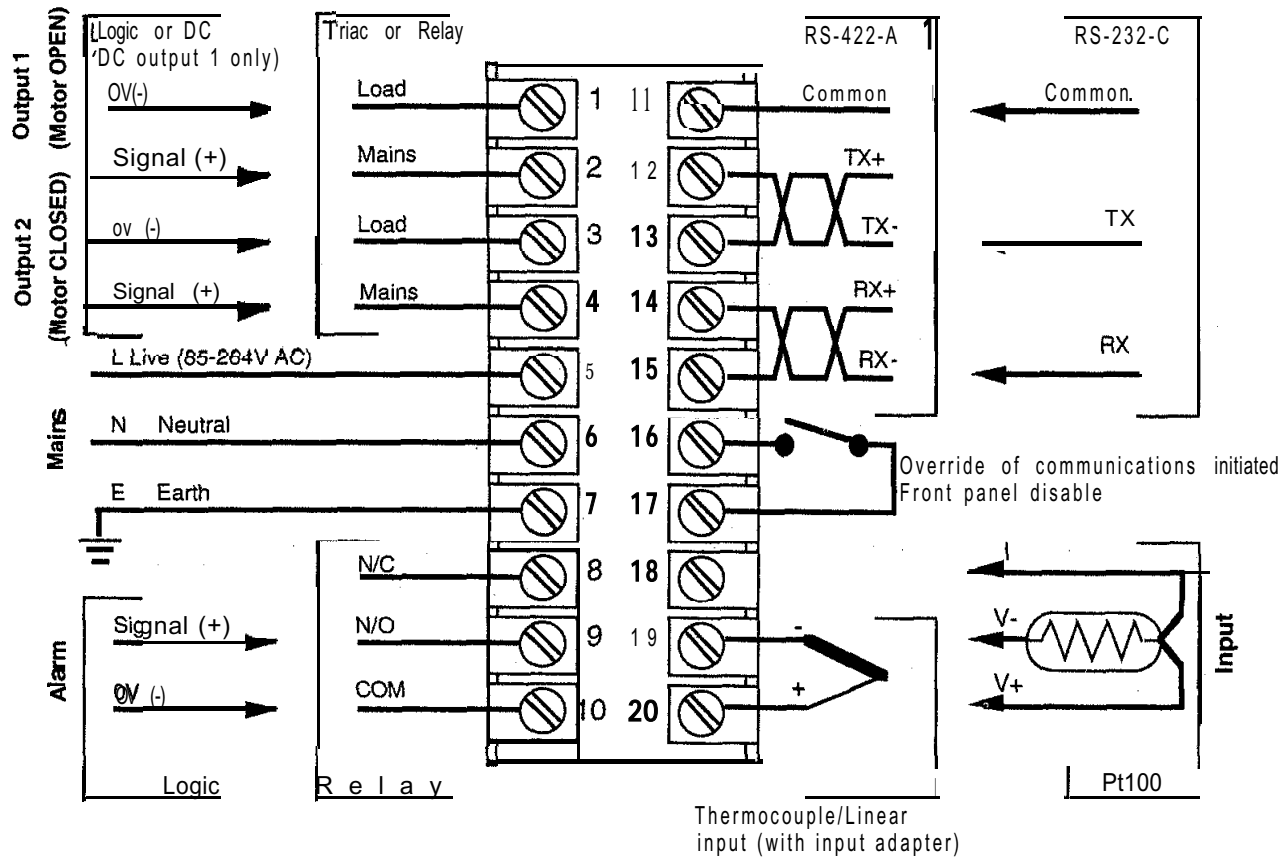

Figure 2.2.1 Terminal allocation

Connecting terminals

Mains supply and earth

The controller can be powered by a mains voltage between 85 and 264 V AC / 50-60 Hz. Connect the Neutral to terminal 6 and the Live to terminal 5. A minimum of 0.5mm² or 16awg wire is recommended. The earth ground of every single instrument should be directly connected to the equipment copper ground bar. Do not connect several earth grounds of an instrument as a chain (“daisy-chain” connection).

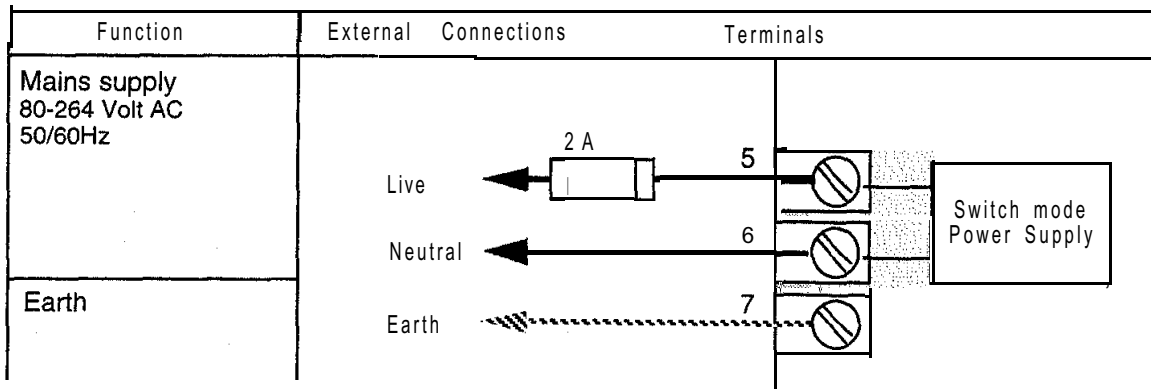

Figure 2.3.1 Mains supply, Terminals 5, 6 & 7

output 1

Output 1 can be fitted with four output module types: triac (TI), relay (RI), logic (LI) or DC (DI). Check the relevant code on the instrument label. The external connections depend on the type of output module installed. If output 1 is configured as time proportioned with power feedback, the mains supply of the instrument must be connected to the same Live as the load supply.

output 2

Output 2 can be fitted with four output module types: triac (TI), relay (RI) or logic (LI) or DC(DI). Check the relevant code on the instrument label. The external connections depend on the type of output module installed.

Output 2 is configurable as either the cool channel or an alarm channel. If it is configured as an alarm channel, the output module cannot be a triac (TI). In the alarm condition, the relay of this alarm output is energised, i.e. in the event of power-down or mains failure etc., the alarm relay does not operate. For this reason this alarm should not be used for critical alarm applications (not failsafe).

The following diagrams show terminal allocation for outputs 1 & 2.

WARNING

The logic and dc outputs are not isolated from the thermocouple input.

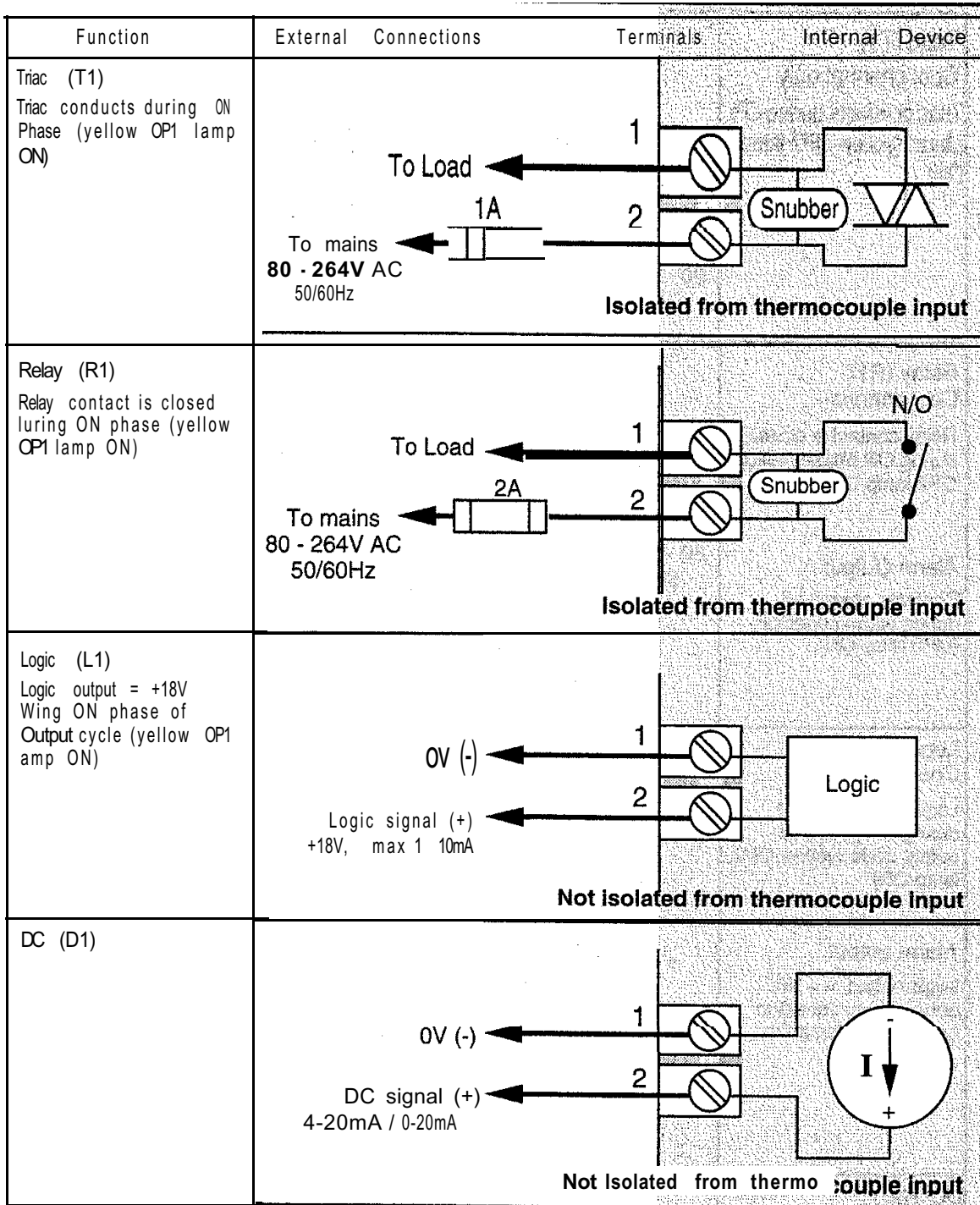

Figure 2.3.2 Output 1, Terminals 1 & 2

Function	External Connections	Terminals	Internal Device
<p>iac (T1) Cool channel only iac conducts during Oh phase (yellow OP2 lamp ON)</p>	<p>To load ← 3 To mains ← 1A 80 - 264V AC 50/60Hz</p>		<p>Isolated from thermocouple input</p>
<p>elay (R1) Cool channel elay contact is closed during ON phase (yellow OP2 lamp ON) alarm Output Contacts energised during alarm condition (OP2 lamp ON)</p>	<p>To load ← 3 To mains ← 2A 80 - 264V AC 50/60Hz</p>		<p>Isolated from thermocouple input</p>
<p>Logic (L1) Cool channel Logic output = +8V during ON phase of output cycle (yellow OP2 lamp ON) alarm output Logic output = +18V during alarm condition (yellow OP2 lamp ON)</p>	<p>0V (-) ← 3 Logic signal (+) ← +18V, max. 10mA</p>		<p>Not isolated from thermocouple input</p>
<p>(D1)</p>	<p>0V (-) ← 3 DC signal (+) ← 4-20mA / 0-20mA</p>		<p>Not isolated from thermocouple input</p>

Figure 2.3.3 Output 2, Terminals 3 & 4

Output 3, Alarm

This alarm channel can be fitted with relay (R1) or logic (L1) output module types. Check the relevant code on the instrument label. The external connections depend on the type of output module installed.

When in the alarm condition, the alarm relay is de-energised. The alarm circuit connected should be fused and designed to operate in a failsafe manner, even in the event of a blown fuse.

In the alarm condition an appropriate annunciation appears on the LED display.

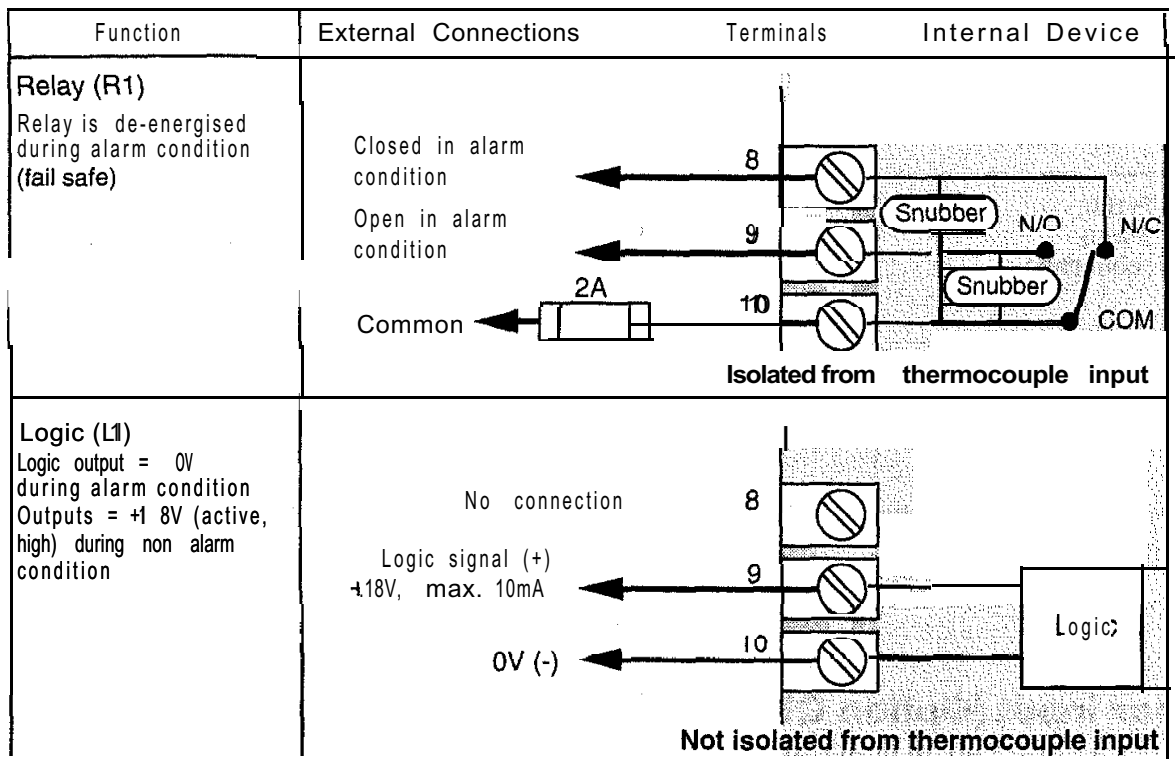

Figure 2.3.4 Output 3, Alarm, Terminals 8, 9 & 10

Input

Thermocouple and RTD inputs can be connected to the measured value input of the instrument, and linear input signals (millivolt and process signals with suitable input adapter) can also be accommodated. For the possible types and ranges of input sensors, please refer to the sections on Technical Data (Section 3) and Product Code (Section 4).

Thermocouple input

Connections between thermocouple and controller must be made with the appropriate compensating cable. Sensor break detection and an internal CJC (cold junction compensation) are built into the instrument. If the instrument is configured for external CJC, the connections between the CJC and the controller must be made with copper wire. Verify that correct polarity is observed at the connection points.

Resistance thermometer (RTD) Pt100, three-wire device

Connect the single wire of the sensor to terminal 19 and the double wire to terminals 18 & 20. The length and gauge of all three wires must be equal. The cable resistance is compensated for by the three-wire device. Sensor break display is shown only if two wires break simultaneously.

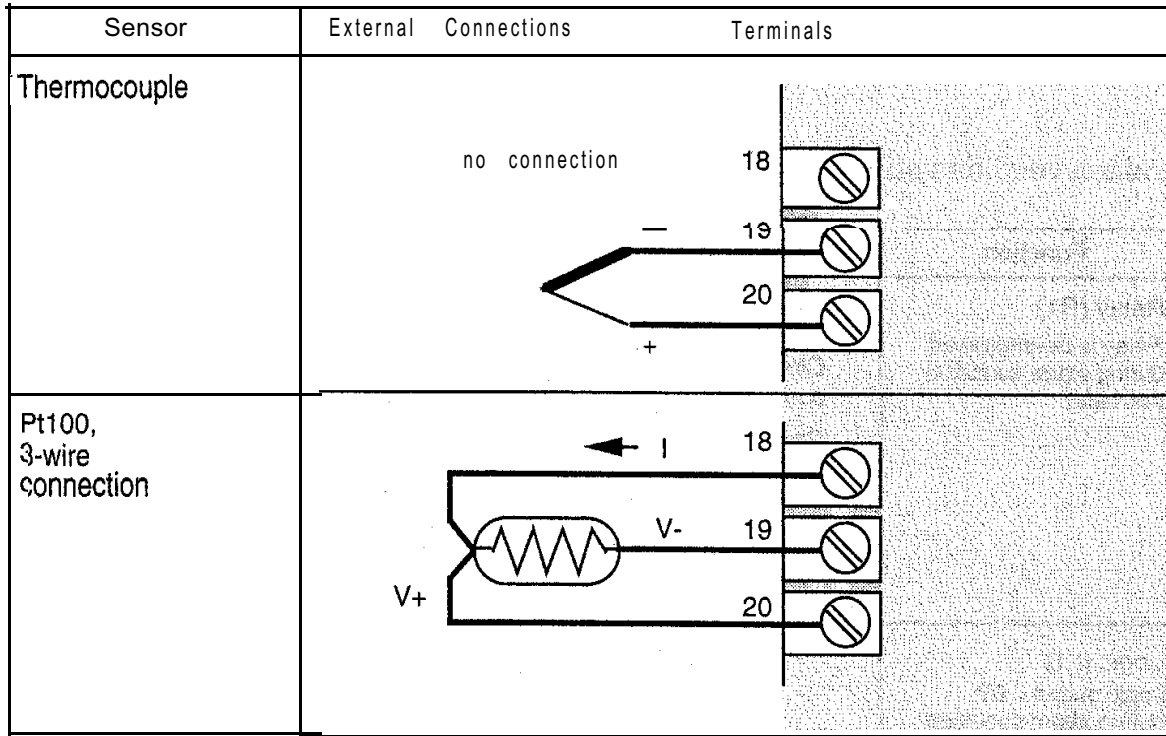

Figure 2.3.5 Sensor input, Terminals 18, 19 & 20

Linear input (Option **QLS...**)

For input signals in the range -10mV to $+50\text{mV}$, connection is made directly to the instrument. As a precaution against interference, a shielded, twisted pair should be used. The shield should only be grounded at the sensor end.

For input signals greater than 50mV and process signals (per unit signals), a suitable input adapter is available. This adapter is delivered with the instrument if ordered. Make sure that it is installed directly on to the instrument terminals. Again, use a shielded, twisted pair.

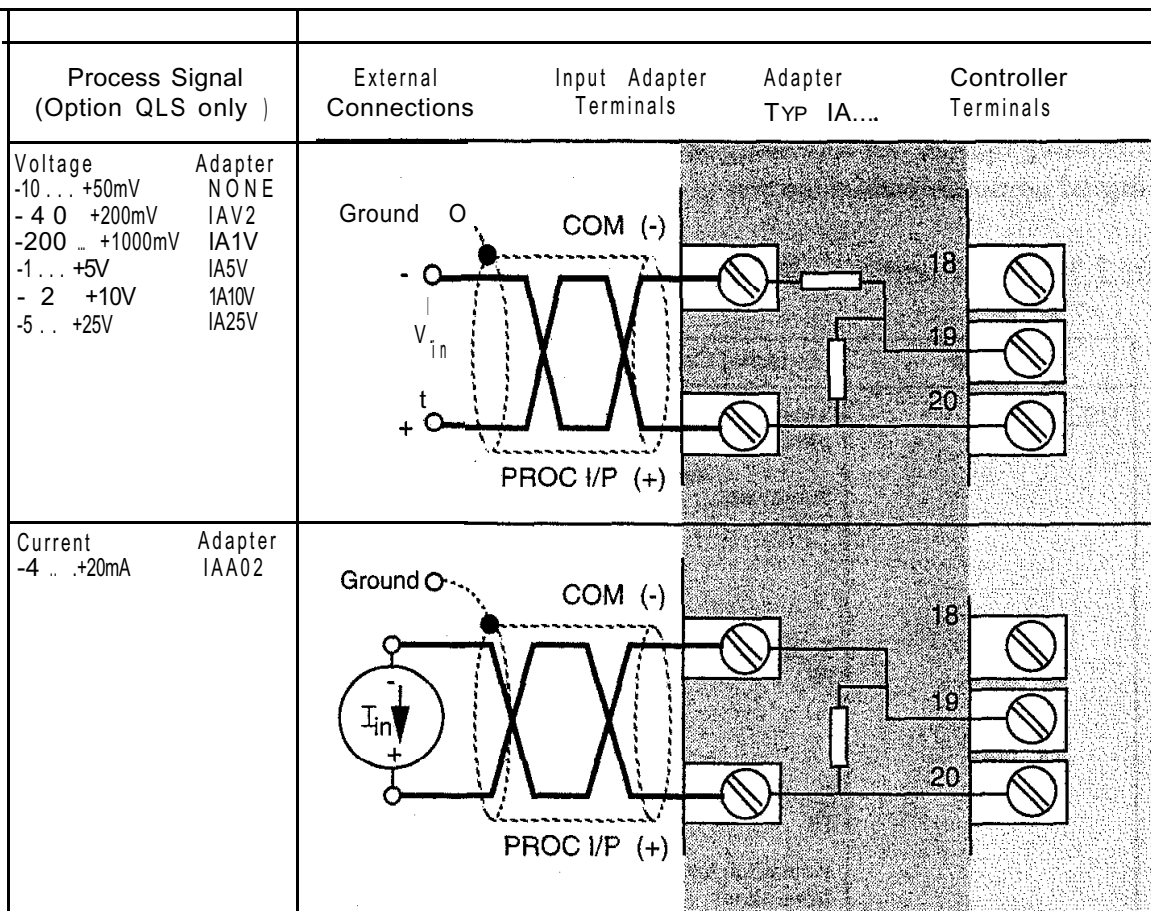

Figure 2.3.6 Linear input, Terminals 18, 19 & 20

Digital communications (option)

Verify on the instrument label if an EIA232 or an EIA422 interface is installed.

EIA232: Terminal 15 is for receiving (RX) and terminal 13 for transmitting (TX) on the EIA232 communications board, terminal 11 is common, This communications board is designed for point-to-point operation. Transmitting and receiving links are made between the supervisory computer and the controller. The cable length should be limited to 15m.

EIA422: Terminal 11 is common and should be connected via a ground conductor to the supervisory computer chassis, as a precaution against interference. The EIA422 communications board uses terminals 14 (RX+) and 15 (RX-) for receiving and terminals 12 (TX+) and 13 (TX-) for transmitting. This communications board is designed for a maximum of 32 instruments. Cable lengths should be limited to a maximum of 1200m.

Front panel lock-out override: If terminals 16 & 17 are connected together for a short period, lockout induced by a supervisory computer may be overridden. This function is necessary if an error has been made in communication with the supervisory computer, and there is a need to operate the controller manually despite the front panel lock-out. Further ways of overriding a lock-out are by switching the instrument off for a short period or by an appropriate command from the supervisory computer.

If the instrument is configured as a programmer / controller, terminals 16 & 17 no longer serve as a lock-out override, but instead take on functions associated with the setpoint programming option, see following sections.

The digital communications output is isolated from the thermocouple input.

Figure 2.3.7 shows terminal allocation for in-built digital communications.

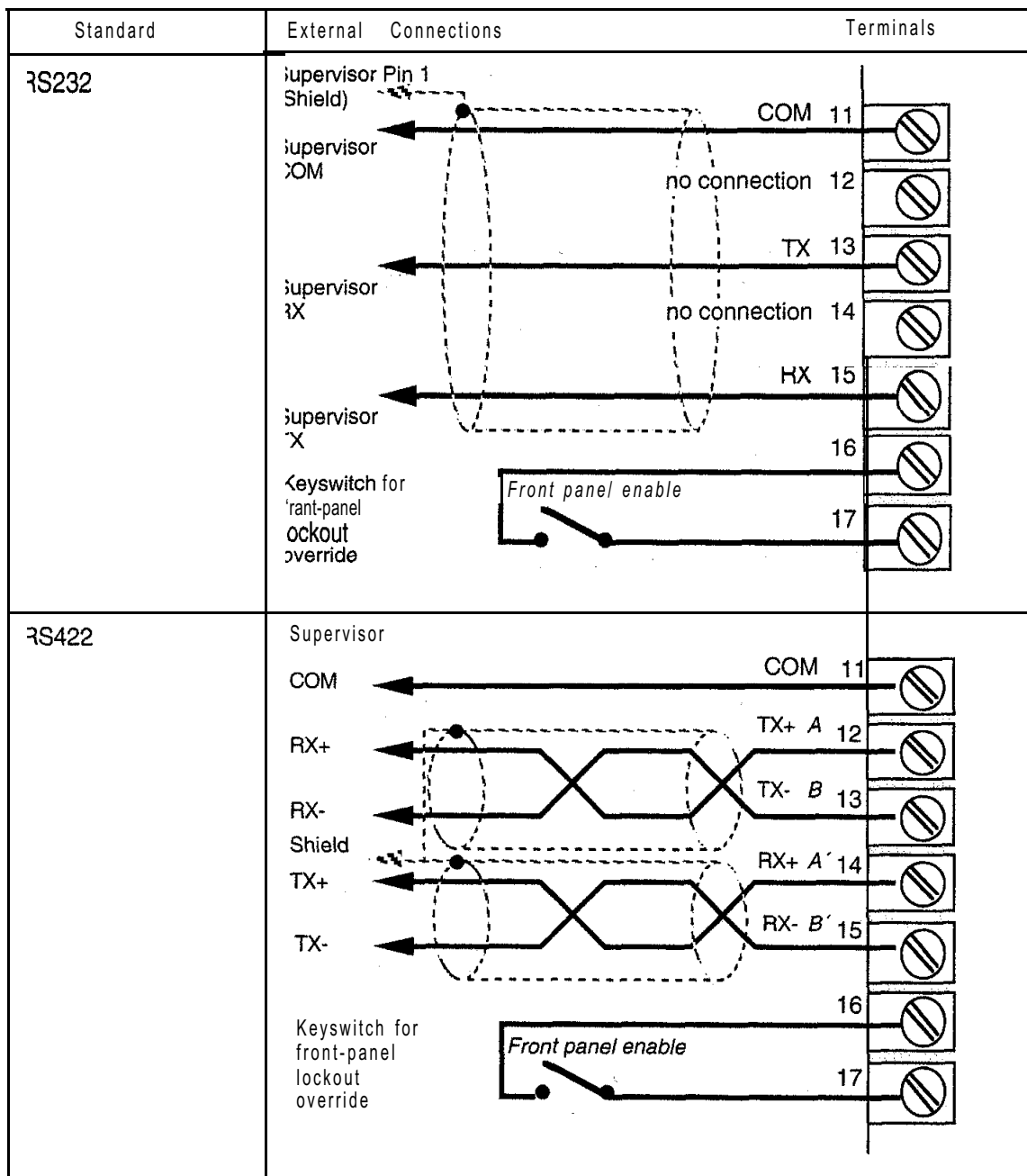

Figure 2.3.7 Digital communications, Terminals 11 to 17

Programmer / controller (Option QLPS), **setpoint** programming option

If the instrument is configured as a programmer / controller (see instrument label), the RUN and HOLD states of a given program are controlled via terminals 16 & 17. Figure 2.3.8 shows possible connections. The function of the programmer / controller is described in later sections

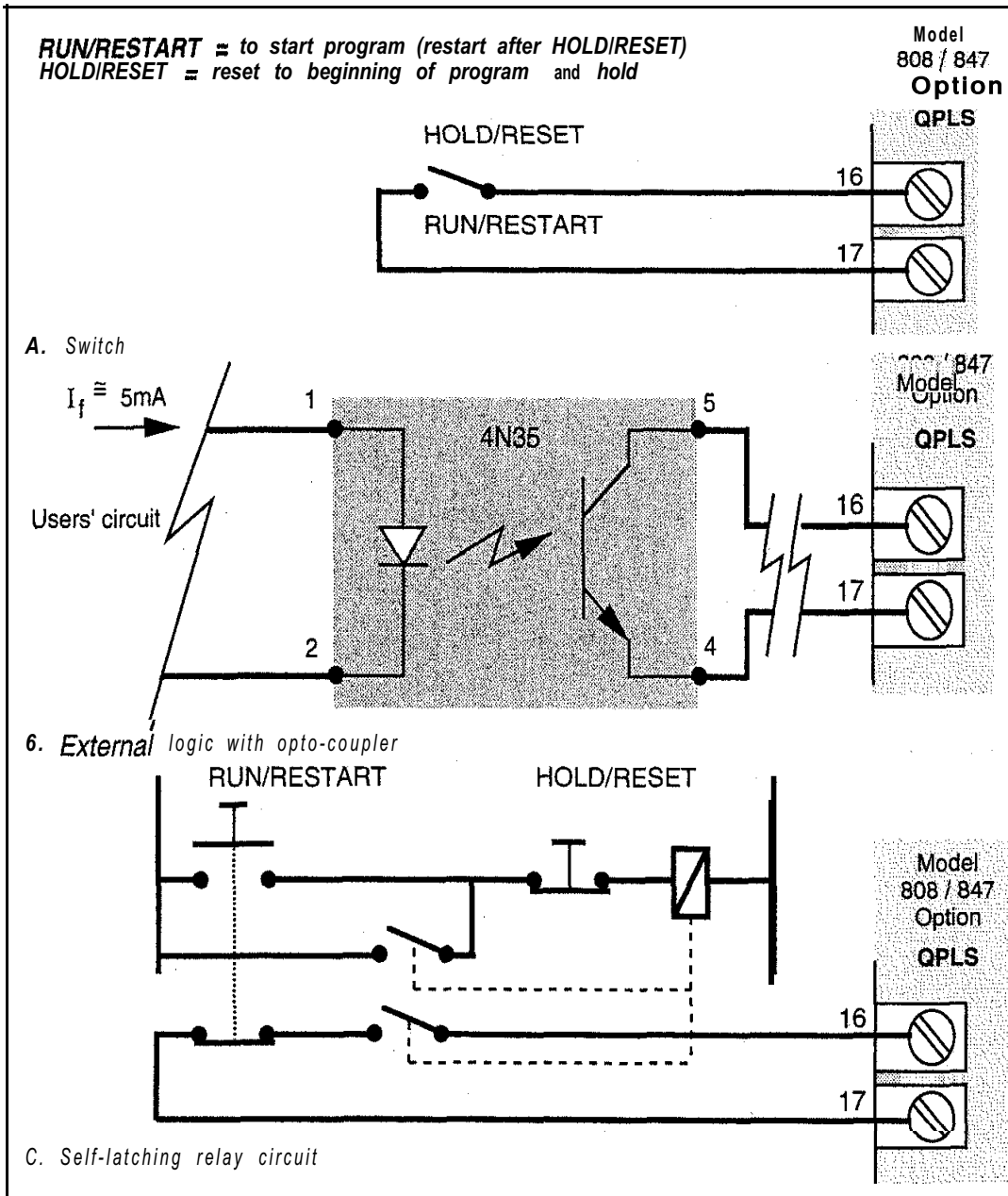

Figure 2.3.8 Setpoint programming option, Terminals 16 & 17

WARNING

The logic input circuits are not isolated from the thermocouple input.

TECHNICAL SPECIFICATION

Environmental ratings

Panel sealing:	Instruments are intended to be panel mounted. The rating of panel sealing is IP54, (EN 60529), or NEMA 3 when used with the optional gasket kit, part number LA 022339.
Operating temperature:	0 to 50°C. Ensure the enclosure provides adequate ventilation.
Relative humidity:	5 to 95%, non condensing.
Atmosphere:	The instrument is not suitable for use above 2000m or in explosive or corrosive atmospheres.

Equipment ratings

Supply voltage:	85 to 264Vac.
Supply frequency:	48 to 62Hz.
Power consumption:	5 Watts maximum.
Relay (isolated):	Maximum: 264Vac, 2A resistive. Minimum: 10Vdc, 100mA. Channel 1 and 2 as form C, (closing contacts). Channel 3, (Alarm 1) as form A, (change-over contact).
Triac outputs (isolated):	Maximum: 264Vac IA resistive. Minimum: 80Vac, 50mA.
Leakage current:	The leakage current through triac and relay contact suppression components is less than 2mA at 264Vac, 50Hz.
Over current protection:	External over current protection devices are required that match the wiring of the installation. A minimum of 0.5mm ² or 16awg wire is recommended. Use independent fuses for the instrument supply and each relay or triac output. Suitable fuses are 2A type T, (EN 60127 time-lag type).
Low level i/o:	All input and output connections other than triac and relay are intended for low level signals less than 42V.
Logic output (Non-isolated):	18V at 10mA (Max. current: 20mA).
DC output (Non-isolated):	0 to 20mA (600W max.), 0 to 10V (500W min.).
Fixed digital input:	Contact closure, (non isolated).
Digital Communications:	EIA-232, or 4-wire EIA-485, (both isolated). ANSI X3.28, subject 2.5 and A4.
Address range:	00 to 99.
Baud rate:	Adjustable as: 300, 600, 1200, 2400, 4800, 9600, 19200 Baud.
Character format:	7 data bits, even parity bit, 1 stop bit.

General

Dimensions:	See Chapter 2.
Weight:	0.55Kg, (1.21lbs) including sieve and mounting clamps.
Resolution:	12 bit, (0.7mV)
Sample rate:	125ms, corresponds to 8 measurements per second.
Common mode rejection:	>120dB at 264Vac, 50 / 60Hz.
Calibration accuracy:	0.25% of reading, +1 LSD or +1 degC
Cold junction compensation:	Internal, >20: 1 rejection of ambient temperature. External configurable as 0°C, 45°C or 50°C.
Maximum lead resistance:	1 000R
Thermocouples:	J, B, E, N, K, L, R, S, PL2 and T.
Thermocouple linearisation:	DIN 43710; DIN IEC 584 I(84); BS 4937 (73); ASTM E 230(72)

Linearisation accuracy: <+0.2 °C.
 RTD linearisation: DIN 43760; BS 1904
 Linearisation accuracy: <+0.1 °C.
 Maximum lead resistance: 10Ω

Electrical safety

Standards: EN 61010, Installation category II, pollution degree 2.
 CSA C22.2 No.142-M1987.
 Installation category II: Voltage transients on any mains power connected to the instrument must not exceed 2.5kV.
 Pollution degree 2: Conductive pollution must be excluded from the cabinet in which the instrument is mounted.
 Isolation: All isolated inputs and outputs have reinforced insulation to provide protection against electric shock. The fixed digital input and non-isolated logic and dc outputs, are all electrically connected to the main process variable input, (thermocouple).

Input/output functions

Heat: PID/PD/PI/P (with or without ramp-to-setpoint function), DC or time proportioned switching with adjustable cycle time (0.3 to 80s), power feedback configurable; ON/OFF with relay, logic and triac modules, hysteresis adjustable. Output action reverse or direct, configurable.
 Cool/alarm: Time proportioned switching with relay, logic or triac module, adjustable cycle time (0.3 to 80s). Cool characteristic (minimum ON time): fan cooling linear (500ms), oil cooling linear (35ms), water cooling non-linear (35ms), linear cooling (minimum ON time = 5% of cycle time) configurable; output can also be configured as alarm (if heat only).
 Alarm output: Two alarm outputs with full-scale high, full-scale low and deviation band alarm types configurable, each alarm type has its own setpoint, with 1 °C hysteresis. Alarm latching configurable for each alarm type. Alarm output 1 configurable as collective alarm for all alarm types, relay de-energised in alarm condition (failsafe); alarm output 2 configurable, relay energised in alarm condition,

Control parameters

Proportional band range: 1 to 4500°C (1 to 8100 °F) or 1 to 300% of the measurement range; linear input 1 to 9999 units.
 Integral time: 1 to 8000 seconds or OFF.
 Derivative time: 1 to 999 seconds or OFF.
 Hysteresis: For ON/OFF controllers, as proportional band range in °C.
High/low cutback: 1 to 2000°C/0. 1 to 500.0°C for start-up overshoot suppression.
 Relative cool gain multiplier: 0.1 to 10.0 as a factor of the proportional band (heat).
 Output limit: 0.0 to 100% limit of control output.
 Sensor break output: -99.9 to 0.0 to +100.0% output, detects 10% of measurement range over- or underrange.
Setpoint limit: Upper and lower setpoint limit adjustable over the complete measurement range.
 Ramp-to-setpoint: 0.01 to 99.99 units per minute adjustable ramp-to-setpoint.

Self-tuning: Automatic adjustment of control parameters in start-up phase or when required.

Auto/manual behaviour: Bumpless transfer to manual operation, adjustable -99.9 to 100.0%.

Programmer/controller

Programs/segments: One program with four segments, consisting of ramp 1/dwell period 1/ramp 2/dwell period 2.

Program parameters: 0.01 to 99.9 units per minute setpoint ramp rate, target setpoint value within measurement range, 0 to 9999 minutes dwell period, 1 to 200 or continuous program repeats.

Holdback: 1 to 2000 °C (1 to 3600 °F), 1 to 9999 units linear / 0.1 to 500.0 °C (0.1 to 900.0 °F), 0.1 to 999.9 units linear with tenths' precision; program hold in the case of control deviation.

Baud rate/character format: Adjustable 300,600, 1200,2400,4800,9600, 19200 baud, 7 data bits, even parity bit, 1 stop bit.

PRODUCT CODE

Basic instrument	Code
808, vertical instrument	808
847, horizontal instrument	847
809, vertical instrument	809
849, horizontal instrument	849
Output modules, Output 1 / 2 & alarm	
Output 1, heat	
No output	0
Relay, 2A /264 V AC	R1
Logic, 18 V I 20mA	L1
Triac, /1A/ 264 V AC	T1
DC, 0 to 20mA I 4 to /20mA max. 18 V	D1
Output 2, cool or alarm	
No output	0
Relay, 2A / 264 V AC	R1
Logic, 18 V / 20mA	L1
Triac, 1A / 264 V AC, not for alarm configuration	T1
Output 3, alarm	
No output	0
Relay, 2A / 264 V AC	R1
Logic, 18 V / 20mA	L1
Communications	
No communications	0
RS 232	c2
RS 422	c4
Input adapter	
-10 to 50mV Ri = 500k Ω (standard, thermocouple)	0
-40 to 200mV Ri = 1k Ω	IAV2
-0.2 to 1V Ri = 5.2k Ω	IAIV
-1 to 5V Ri = 27k Ω	IA5V
-2 to 10V Ri = 56k Ω	IA10V
-5 to 25V Ri = 56k Ω	IA25V
-4 to 20mA Ri = 2.5 Ω	IAA02
Special functions	
PID controller with self-tuning	QLS
Programmer / controller	QLPS
Linearisation	
Fe/CuNi IEC 5841184 Type J	J
Fe/CuNi DIN 437 10 Type L	L
NiCr/NiAl. Type K	K
Pt13%Rh/Pt Type R	R
Pt10%Rh/Pt Type S	S
Cu/CuNi Type T	T
Platinel II	P
Pt100 DIN 3-wire	Z

Product Code

Linear, with appropriate input adapter, see calibration code X

Measurement range	B	N	E	J	L	K	P	R	S	T	Z	Code
-250 to +250 °C										.		A
-100 to +100 °C			.			.				.		B
-100 to +400 °C				C
-75.0 to +400.0 °C			D
0 to +100 °C	E
0 to +200 °C	F
0 to +300 °C	G
0 to +400 °C	H
0 to 1-600 °C	J
0 to +800 °C			K
0 to +1000 °C		L
0 to +1200 °C		M
0 to +1600 °C								.	.			N
200 to 800 °C	.											P

Linear: Specify in the calibration code input range and input signal (mV, V, mA) and display range (max. -999 to 9999 or -99.9 to 999.9) with units (use only A to Z or a to z - these are for reference and do not appear on the LED display). X

Tenths' precision configurable for J and L thermocouples.

Measurement range for Pt100 (code Z), as a general rule with tenths' precision.

Units

°C	C
°F (measurement ranges on request)	F
Linear, see calibration code	X

Output configuration, outputs 1 / 2 and alarm**Output 1, Heat**

No output	0
Slow cycle time, for output modules R1 / T1 / L1	1
Fast cycle time, for output modules T1 / L1	2
0 to 20mA, for output module D1	3
4 to 20mA for output module D 1	4
ON/OFF for output modules R1 / T1 / L1, only if output 2 = alarm or no output, not for ramp-to-setpoint or setpoint programmer	5

Output 2, cool or alarm

No output	0
Water cooling	1
Oil cooling	2
Fan cooling	3
Full-scale low alarm	4
Full-scale high alarm	5
Deviation band alarm	6

Alarms non-latching (standard), relay energised in alarm condition. Alarm latching configurable.

Output 3, alarm	Code
No alarm	0
Full-scale low alarm	4
Full-scale high alarm	5
Deviation band alarm	6

Alarms non-latching (standard), relay de-energised in alarm condition. Alarm latching configurable.

Operating instructions, a manual is enclosed in the packaging

German	GDR
English	ENG
French (only 808 / 847)	FRA
Dutch (only 808 / 847)	NED

Basic Instrument	Output Modules				Input Adapter	Special Functions	Standard
	Output 1	Output 2	Output 3	Comms.			
8081847							E

Measurement			Output Configuration			
Linearisation	Range	Units	output 1	Output 2	Output 3	Manual

Calibration code for linear input:

Input signal			Measurement range		
Min.	Max.	Units	Min.	Max.	Units
		mV, V, m			AtoZ

OPERATION

Operating structure

The operation of the instrument is structured on two access levels. Within these levels, three operating modes and four control algorithms with their parameters may be selected.

Operator level: The operator level is intended for normal, everyday operation of the controller at the plant. The modifiable parameters on this level are fixed by the commissioning engineer in the **ACCESS** menu.

Configuration level: The configuration level is intended for commissioning the instrument.

Each parameter on the configuration level can be either:

- readable and alterable
- readable only, not alterable
- hidden.

The configuration level is accessible by setting the configuration link/switch (see Figure 5.1.1)

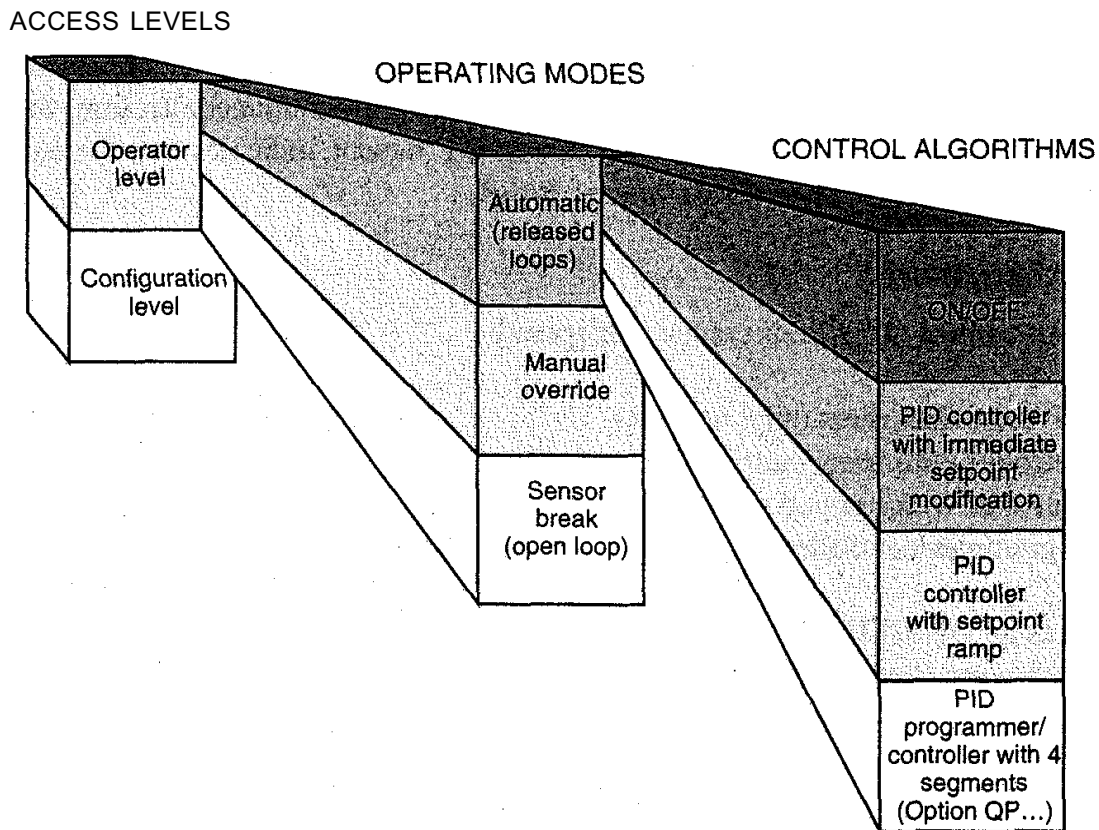

Figure 5.1 .1 Operating structure

Operating modes

The controller can function in three different operating modes. In **automatic** or closed loop, the output of the controller is determined by the control algorithm. In the base condition, the process value and the setpoint appear on the LED display. The setpoint is modified by the **raise** and **lower** buttons. Changeover to manual is through the A/M button (if not locked out, see section 5.4).

If the controller is switched to **manual** operating mode, the output level is operator-adjustable by means of the **raise** and **lower** buttons, control is then open-loop. In the base condition, the process value and the output level appear on the LED display. Illumination of the 'M' beacon indicates **manual** operating mode.

If sensor break is detected at the input of the instrument, an output level defined by the operator, (parameter **SnbP**) is given on the output. The control loop is open here as well. For heat control, the parameter **SnbP** can be adjusted in the range 0 to 100%, and for heat/cool control, in the range -99.9 to 100%.

A sensor break or input error occurs if the input circuit is open or the measured value on the input over- or underranges the linearisation span of the instrument. If the input circuit is open, or the measured value is overrange, the annunciation **SnbP** is shown on the upper display. If the measurement is underrange (e.g. reversed, incorrect thermocouple connection) the annunciation **ur** appears. In both cases, the flashing 'M' beacon indicates that the output level is set at the value determined by the parameter **SnbP**.

Control algorithms

Four different control algorithms can be configured:

- ON/OFF controller (heat only, no cool)
- PID controller with immediate setpoint modification
- PID controller with ramped setpoint modification
- PID programmer/controller with four segments (option QLPS)

Configured as an ON/OFF controller, the instrument functions as a two-state controller with a control switch point (heat output only).

The PID control algorithm includes self-tuning and special parameters for optimal start-up. For setpoint modifications, an adjustable ramp-to-setpoint can be entered which prevents excessive thermal shock to sensitive loads.

Configured as a programmer/controller, the instrument moves through a temperature/time profile with four segments.

Front panel identification

The instrument is operated and also configured by means of four pushbuttons and displays on the front fascia (Figure 5.4.1).

Displays:

The **upper display** indicates the measured value when in the base condition. On selecting a parameter, the appropriate parameter abbreviation appears. If one of the configured alarm conditions occurs, the display flashes.

The **lower display** indicates the setpoint when in the automatic mode and the output level set when in the manual mode. On selecting a parameter, the appropriate parameter value appears here. If one of the alarm conditions occurs, the display alternately flashes alarm type and setpoint.

Both the LED beacons 'OP 1' and 'OP 2', indicate the state of the relevant output. The LED is illuminated when the output is 'on'.

If output 1 is fitted with a DC output, the intensity of the beacon varies with the magnitude of the output level. If the DC output is configured as 4 to 20mA the LED glows dimly even with an output level of 0%.

If output 2 is configured as an alarm output, the LED is illuminated when the alarm is active.

The LED beacon in the upper left corner of the display flashes when the controller is in active communication with a host computer via the digital communications board (only if option 'digital communications board' has been installed).

The LED beacon **R** in the upper display is illuminated when the setpoint is ramping towards the target setpoint (only if ramp-to-setpoint has been configured).

The LED beacon **M** indicates **manual** operating mode, the beacon flashes if sensor break is detected.

Operating buttons:

The defined parameter list is scrolled through in sequence using the **parameter pushbutton** ('**PAR**'). By pressing the button, the abbreviation of the next parameter is shown in the upper display. The value associated with this parameter is shown in the lower display. If no change is made in the following six seconds by pressing the PAR button, the display returns to the base condition. This time-out can be overridden by holding down the PAR button.

In alarm condition, a latched alarm is acknowledged by one press of the PAR button.

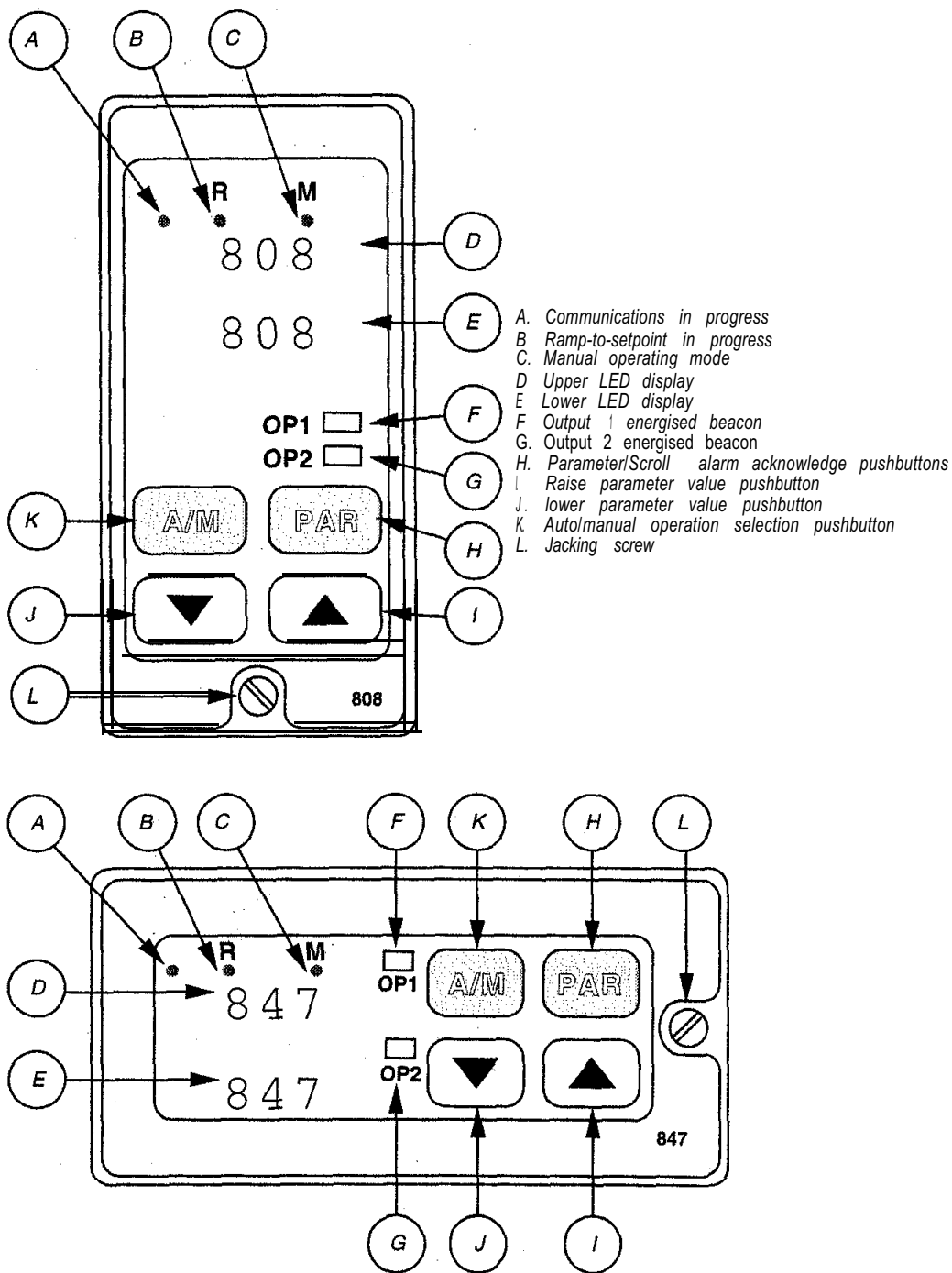

Figure 5.4.1 Front panel displays/buttons

With the **lower pushbutton**, the value of the displayed parameter is decreased (insofar as modification is permitted). The speed increases as long as the button is depressed.

With the **raise pushbutton**, the value of the displayed parameter is increased (insofar as modification is permitted). The speed increases as long as the button is depressed.

With the **automatic / manual button** ('A/M'), the controller is switched from **automatic**

operating mode to the **manual** mode. Depressing the button again returns the controller to **automatic**. The changeover is bumpless, the output level at the time of the changeover is transferred into the required operating mode. If the instrument is configured as an ON/OFF controller, the output level can only assume one of two values (0 or 100%). This button can be locked out in the configuration level, so that the instrument remains in the operating mode chosen before lockout. If the instrument cannot be operated using the pushbuttons, either all of the parameters have been hidden or the front panel buttons are locked out through digital communications,

Operating procedures

According to its configuration, the instrument reacts in various ways to modifications to the setpoint, parameters and operating procedures,

The reactions depend on the control algorithm configured:

- . PID controller with immediate setpoint modification
- . PID controller with ramped setpoint modification
- . PID programmer/controller with four segments (option QLPS)

PID controller with immediate setpoint modification:

The setpoint can be freely modified between the configured limits (see parameter list), when the actual value is indicated in the upper display and the setpoint in the lower display. The setpoint modification is transferred by the controller immediately into the control algorithm.

Ramped setpoint modification:

This function is configured in the parameter 'Ctrl' by selecting 'SP'. Excessive thermal shock to sensitive loads is prevented by bumpless start-up to the required setpoint. The ramp-to-setpoint is independently activated by powering up the instrument or by modifying the setpoint. The instantaneous control setpoint is modified by adjustable ramping. It begins with the original process value and ends with the adjusted target setpoint. The ramp rate is selectable by the 'Sprr' parameter in °F/min or °C/min, alternatively display units/min.

During ramp-to-setpoint the process value is indicated in the upper display and the target setpoint in the lower. The **R** beacon is illuminated until the target setpoint has been reached. In order to view the instantaneous setpoint, the PAR button must be pressed once. The **R** beacon flashes during display of the instantaneous setpoint.

With the 'Hb' (holdback) parameter the maximum allowable deviation between the process value and the instantaneous setpoint can be defined. The value is directly entered in LED display units. If the deviation exceeds **Hb**, ramping is halted and the **R** beacon flashes. The function of holdback is further explained below.

If the ramp rate or the target setpoint is modified during ramp-to-setpoint, this modification directly affects active ramping, see Figure 5.5.1 for further clarification,

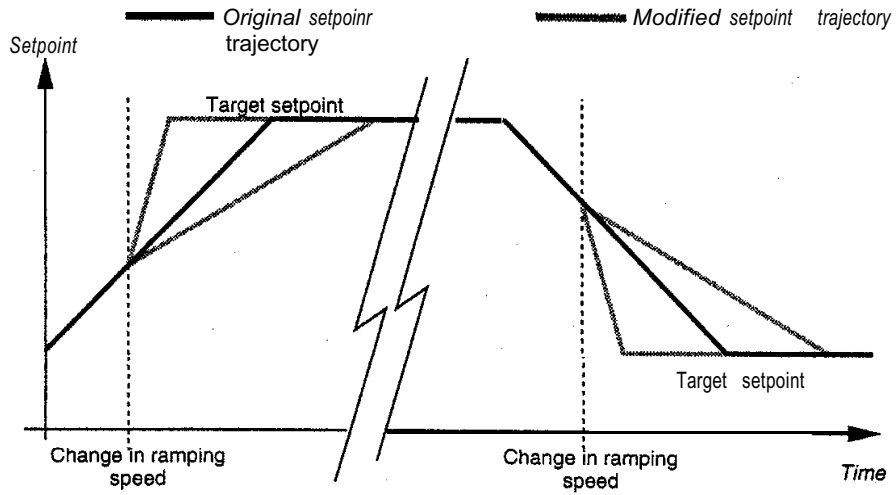

A. Change in ramping speed

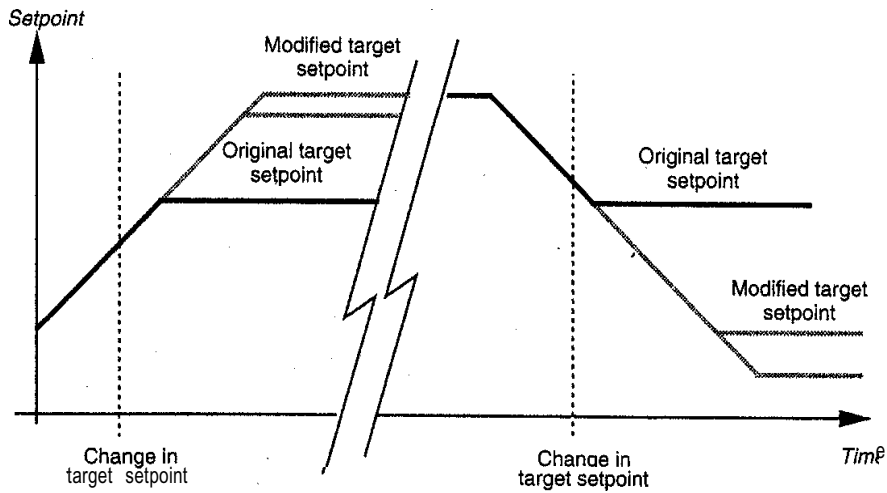

B. Change in target setpoint: ramping leads to new target setpoint

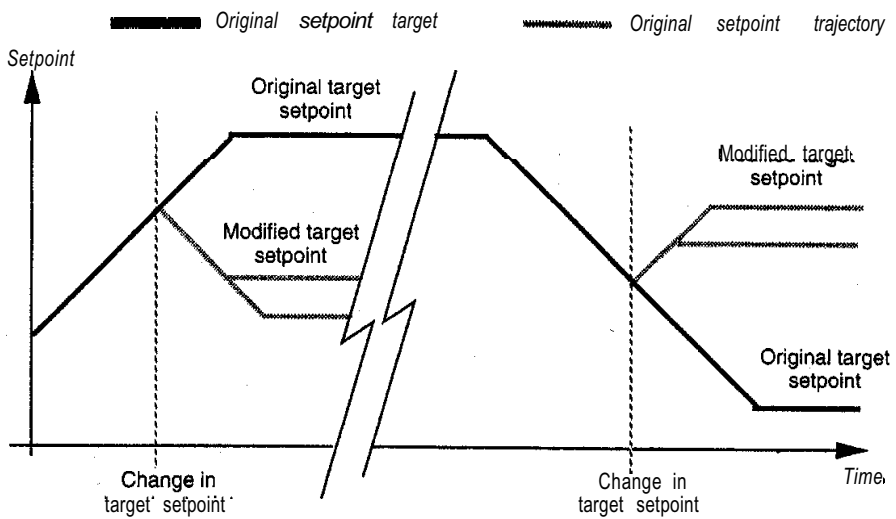

C. Change in target setpoint new setpoint already exceeded by ramp

Figure 5.5.1 Parameter changes during ramp-to-setpoint

Alarms

Two alarm outputs may be installed in the controller. Three different types of alarm can be set up with these alarm outputs by configuration:

- Full-scale high alarm (H AO)
- Full-scale low alarm (L AO)
- Deviation band alarm (d AO)

In the alarm condition, the alarm outputs fitted and configured with the appropriate modules are energised. Alarm output 1 and alarm output 2 possess different characteristics.

Alarm 1 and Alarm 2

lower display flashes

HI AL
Lo AL
and/or
d AL

alternating with the setpoint

if

one of the alarm conditions,
defined by the following
parameters, is active

HI AL
Lo AL
and/or
d A R

A. Alarm annunciation "Soft-alarm"

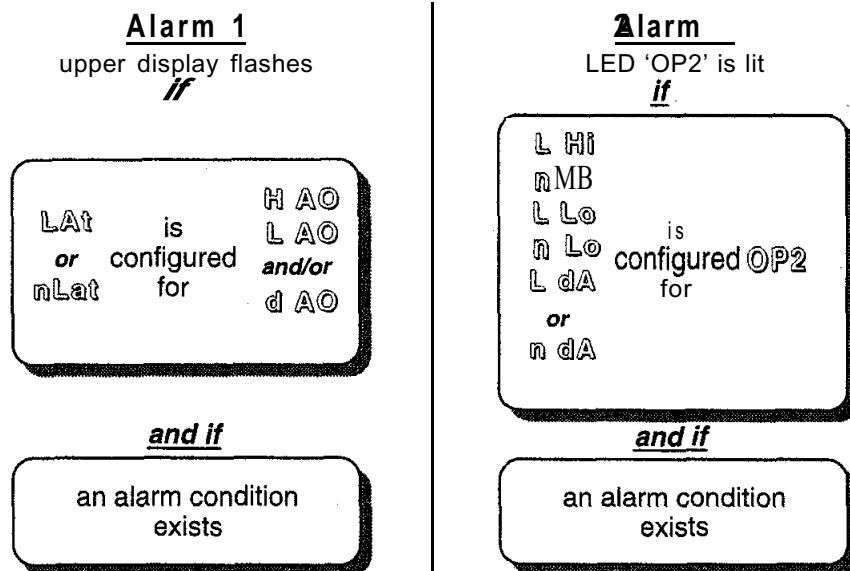

B. Alarm annunciation, alarm outputs 1 and 2

Figure 5.6.1 Alarm annunciations

Alarm output 1 (fitted with the appropriate module) operates as the collective alarm for all configured alarm types, i.e. it operates if at least one of the configured alarm conditions occurs. The function of the alarm output can be configured for each type of alarm as ‘latching’ (**LAt**), ‘non-latching’ (**nLAt**) or as ‘not active’ (**OFF**). If the appropriate alarm type is configured as non-latching, it is then a ‘soft-alarm’ in the instrument. In the alarm condition, the setpoint on the lower display flashes alternately with the alarm type. If the alarm type is associated with alarm output 1 by configuration of **LAt** or **nLAt**, a flashing of the actual value in the upper display signals, additionally, the active alarm output.

One of the three possible alarm types can be associated with **alarm output 2**. The alarm output must be fitted with the appropriate module and should not be configured as a cool output. In an alarm condition the LED ‘**OP 2**’ signals the active alarm output.

If an alarm type is configured as ‘latching’, the alarm annunciation on the LED display must be acknowledged by pressing the ‘**PAR**’ button. Acknowledgement is not possible until after the alarm condition has cleared. With a non-latching alarm, the alarm annunciation disappears as soon as the alarm condition has cleared.

Sensor break

If a **sensor break** is detected at the input of the instrument, one of the output levels defined by the user (**SnbP** parameter) is given on the output. The control loop is therefore open. The **SnbP** parameter can be adjusted for heat control in the range 0 to 100% and for heat/cool control in the range -99.9 to 100%.

A sensor break and likewise an input error occurs when the input is open circuit or the measured value at the input over- or underranges the linearisation span of the instrument. If the input is open circuit or the measured value is overrange, the annunciation **SnbP** appears on the upper display. In an underrange condition (reversed polarity or wrong thermocouple connection) the annunciation **ur** appears. In both cases, the flashing **M** beacon indicates that the output level is set at the value defined by the parameter **SnbP**.

If, on the configuration level, a change in operating mode has been authorised to **manual**, the operator can directly modify the output level with the raise or lower buttons. By pressing the **A/M** button once, the operator can enter definitively **manual** mode. This operating mode can only be quitted after the sensor break condition has been corrected and by pressing the **A/M** button again. If the **manual** operating mode is not abandoned, the output level cannot be modified by the operator if a sensor break has occurred.

Self-test

An in-built self diagnostic routine checks the instrument for faults. If an internal instrument fault occurs, the annunciation **CErr** is shown on the lower display. Close the configuration link/switch and select, with the **PAR** button, the parameters **CAch** and **EEch** (at the end of the parameter list). Note the parameter values displayed and the version number of the software and return the instrument with details of the parameter values and a description of the fault, to

the nearest EUROTHERM branch for inspection. Under no circumstances should the faulty instrument be used.

CONFIGURATION LEVEL, OPERATOR LEVEL

Configuration link/switch

There are over 30 parameters maintained in the non-volatile memory of the instrument. These parameters are pre-set according to the product code and corresponding standard values, but can, however, be modified at any time by commissioning staff allowing for the available and externally connected hardware.

The parameter list is presented differently in the operator level and the configuration level: in the configuration level all the available parameters in the instrument are listed. In addition, a menu is available for calibrating and defining the modifiable parameters in the operator level.

In the operator level, only those parameters are listed which have been configured by the commissioning staff in the **ACCESS** menu as 'readable and alterable' or 'readable only, not alterable'.

Thus, commissioning on the configuration level consists of the configuration and parameterisation of the instrument and determining which parameters should be shown and modified at the operator level.

During the changeover to configuration level, the instrument must be removed from the sleeve, and the configuration link/switch (Figure 6.1.1) must be closed. After this the instrument is replaced in the sieve and is powered up.

WARNING

Configuration should only be undertaken by trained personnel who are fully conversant with the instrument. For normal instrument operation, the configuration link/switch should always be open.

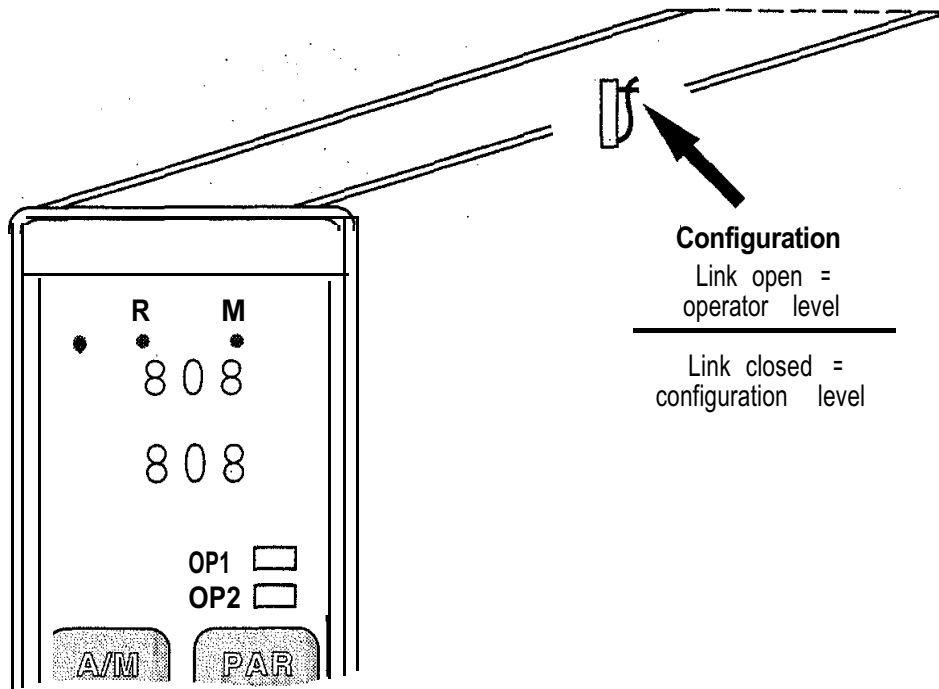

Figure 6.1.1 Configuration link/switch

Hardware configuration

It is important to note in the configuration of the instrument that the configuration parameters possible for an output (**OP 1**, **OP 2** or **AL 1**) depend on the output module installed.

Depending on the output module, only certain configuration values may be selected. Figure 6.2.1 shows the possible combinations of configuration parameters with output module. Use this table if re-configuring the instrument.

OP Module	OUTPUT CONFIGURATION						ALARM 1
	OUTPUT					On	
	OP 1		OP 2				
	Time prop	DC output	Cool.	Alarm 2			
tP Pfb	4-20 0-20	FAn H2O	OIL 0.5	L Hi L Lo	n Hi n Lo	H AO L AO d AO	
Triac (T1)	•			•			•
Logic (L1)	•			•	•	•	•
Relay (R1) only if H c.t & C c.t ≥ 5s	•			•	•	•	•
DC (D1)		•		•			

• = Permissible combination of configuration parameter and output module

Figure 6.2.1 Hardware configuration

Parameter list

All parameters available in the instrument are listed on the following pages. The sequence of parameters corresponds to the sequence in the instrument, as it appears after pressing the PAR button. Some parameters influence the appearance, and similarly the disappearance (HideE), of other parameters, e.g. the cool cycle time is hidden if no cool output channel is configured. Other parameters depend on the firmware options of the instrument.

The first column in the parameter list contains the parameter abbreviation (mnemonic), as it appears when selected in the upper display. For those parameters which are continuously modifiable, the adjustable range is listed; for those parameters having discrete values, the possible parameter values are specified.

* indicates software version 02.00 and ** indicates software version 03.00

If the instrument is to be re-configured it is advisable first to fix the parameters Sn, **Ctrl**, OP 1 and OP 2, as many other parameters depend on these.

Mnemonic	Parameter	Adjustable range	Factory setting	Comments
LOWER PARAMETER LEVEL				
SP	Setpoint	Upper limit: 'SP H' Lower limit: 'SP L'	25°C (70 °F)	Displayed in auto without mnemonic. Displayed in manual with mnemonic. Becomes current programsetpoint if 'Ctrl' configured as 'Prog' and programmer status = 'Run', 'Hold', or 'Hb'.
None	Output level	-99.9 to + 100.0% (heat/cool) 0.0 to 100.0% (heat only)		Display only in manual, without mnemonic ('M' beacon is lit).
C or F (plus active program segment)	Display units	Display only		No units for linear input. Active program segment only if status is 'Run', 'Hold', or 'Hb'.
PROGRAMMER/CONTROILER (Option QLPS...)				
<i>These parameters appear only if 'Ctrl' is configured as 'Prog'</i>				
Prog	Programmer/controller status (display & selection)	Closed loop control Program running Program halted	Idle run Hold	idle
SP	Setpoint in closed loop	Upper limit: 'SP H' Lower limit: 'SP L'		25°C (70°F)
tunE **	Active self-tune		OFF on	OFF
LC	Program repeat counter	1 to 200 or 'cont' (continuous)*		1
r1	Ramp rate 1	0.01 to 99.99 units/minute		10.00°/minute
L1	Target setpoint 1	Measurement range		25°C (70°F)
d1	Dwell time 1	0 to 9999 minutes		1 minute
r2	Ramp rate 2	0.01 to 99.99 units/minute		10.00°/minute
L2	Target setpoint 2	Measurement range		25°C (70°F)
d2	Dwell time 2	0 to 9999 minutes		1 minute

PROGRAMMER/CONTROLLER (Option QLPS...)continued

These parameters appear only if 'Ctrl' is configured as 'Prog'

Hb*	Holdback (without tenths' precision)	1 to 2000°C 1 to 3600°F 1 to 9999 units	100" or units	Only appears if 'Ctrl' is configured as 'Prog' or 'rSP
	Holdback (with tenths' precision)	0.1 to 500.0°C 0.1 to 900.0°F 0.1 to 999.9 units	100.0" or units	Tenths' precision if measured range is so configured
ALARM				
Hi Al	Full-scale high alarm	Measurement range	M-range upper limit	
Lo Al	Full-scale low alarm	Measurement range	M-range lower limit	
d Al	Deviation alarm (without tenths' precision)	1 to 2000°C 1 to 3600°F 1 to 999.9 units	30°C (50°F)	
	Devistion alarm (with tenths' precision)	0.1 to 500.0°C 0.1 to 900.0°F 0.1 to 999.9 units	30.0°C (50.0°F)	Tenths' precision if measurement range is so configured
CONTROL PARAMETERS				
Prop	Proportional band (without tenths' precision;	1 to 4500°C (1 to 300%) 1 to 8100°F (1 to 300%) 1 to 9999 units (1 to 810%)	40°C (60°F) for 'Pid' 'r SP" & 'Prog' 3 °C (5°F) hysteresis for 'On.Of	Becomes hysteresis if control is configured as 'On.of
	Proportional band (with tenths' precision)	0.1 to 500.0°C (1 to 450.0%) 0.1 to 900.0°F (1 to 810.0%) 0.1 to 999.9 units (1 to 810.0%)		Unit corresponding to parameter Pb.d. Decimal point in lower right display indicates degrees or process units, no decimal point indicates percentage.
Int.t	Integral time constant	OFF and 1 to 8000s	360s	Disappears if 'Ctrl' = 'On.Of
dEr.t	Derivative time constant	OFF and 1 to 999s	60s	Disappears if 'Ctrl' = 'On.Of
rEL.C	Relative cool gain	0.1 to 10.0	0.5 (Water cooling) 1 .0 (Oil cooling) 2.0 (Fan cooling)	Disappears if 'OP 2' configured as alarm or 'OFF', or 'Ctrl' = 'On.Of'. Parameter is output module dependent.
H c.t	Heat cycle time	0.3 to 80.0s	20.0s (slow cycle) 0.3s (fast cycle)	Disappears if 'OP 1' configured as 'O-20' or '4-20' or 'Ctrl' = 'On.Of'. Parameter is output module dependent.

Mnemonic	Parameter	Adjustable range	Factory setting	Comments
CONTROL PARAMETERS (continued)				
c c.t	Cool cycle time	0.3 to 80.0s	20.0s	Disappears if 'OP 2' configured as alarm or 'OFF', or 'Ctrl' = 'On.Of'. Parameter is output module dependent.
H cb	High cutback start-up optimisation (without tenths' precision)	1 to 2000 °C 1 to 3600 °F 1 to 9999 units	120 °C (180 °F)	Appears only if 'Cb 0' parameter config. as 'HAnd'
	High cutback start-up optimisation with tenths' precision	0.1 to 500.0 °C 0.1 to 900.0 °F 0.1 to 999.9 units		
L cb	Low cutback	As 'H cb	120 °C (180 °F)	As 'H cb'
SETPOINT LIMITS				
SP H	Setpoint high limit	Measurement range		always > 'SP L
SP L	Setpoint low limit	Measurement range		always < 'SP H'
ALARM 1 OUTPUT				
HAO	Full-scale high alarm	Latched	LA _t	Parameter is output module-dependent
		Non-latched	nLA _t	
		Off (soft alarm)	OFF	
LAO	Full-scale low alarm	Latched	LA _t	Parameter is output module-dependent
		Non-latched	nLA _t	
		Off (soft alarm)	OFF	
dAO	Deviation band alarm	Latched	LA _t	Parameter is output module-dependent
		Non-latched	nLA _t	
		Off (soft alarm)	OFF	
OUTPUT POWER/LIMITS				
H PL	Max output power	0.0 to 100%	100%	
SnBP	Sensor break power	-99.9 to + 100.0% (heat/cool) 0.0 to 100.0% (heat only)	0.0%	

MEASURED VALUE INPUT

These parameters appear only if 'Sn' is configured

OFst	Input/calibration offset	-9.99 to 99.99	0.00 °C or °F	
CF	°C / °F unit selection	Degrees Centigrade C Degrees Fahrenheit F		Affects all temperature dependent parameters
Sn	Linearisation	J thermocouple K thermocouple PL2 thermocouple R thermocouple S thermocouple T thermocouple J th'couple (1/10's prec) Ptl 00, 3-wire L thermocouple L th'couple (1/10's prec) Linear input Linear input (1/10's prec)	J tc CAtc PL2 r tc s tc t tc .Jtc rtd3 L tc ** .Ltc ** Lin * .Lin *	

DIGITAL COMMUNICATIONS BOARD

Parameters appear even if no digital comms board installed, but are inoperative

Addr	Instrument address	0.0 to 9.9	0.0	
bAud	Baud rate	300 baud 600 baud 1200 baud 4800 baud 9600 baud 19,200 baud	300 600 1200 4800 9600 19.2 *	

GENERAL CONFIGURATION

idno	Identification number	0 to 9999	0	For communications board identification No direct control function
Ctrl	Control algorithm	ON/OFF PID PID with rbmp. to SP PID program'r/controller	On-Of Pid rSP Prog	Available only if option QLPS... installed
SPrr	Ramp-to-setpoint	0.01 to 99.99 units/min	10.00 %/min	Only appears if 'Ctrl' = 'r SP

Mnemonic	Parameter	Adjustable range	Factory setting	Comments
GENERAL CONFIGURATION (continued)				
OP 1	output 1 (hardware configuration)	Time-proportioned 0-20mA 4-20mA Time-proportioned with power feedback	IP 0-20 4-20 PFb *	Parameter is output module dependent Feedback of mains fluctuations: connect controller & load to same Live
OP2	output 2 (hardware configuration) Cooling algorithm	Off Fan cooling, linear Oil cooling, linear Water cooling, non-linear Linear, 5% min cycle	OFF FAn OIL H2O 0.05	Parameter is output module dependent Min. 500ms unit 'Min. 35ms unit Condensing water cooling (35ms unit) Min. 5% of C c.t as unit
	Output 2 alarm	Latched high alarm Non-latched high alarm Latched low alarm Non-latched low alarm Latched deviation alarm Non-latched dev. alarm	L Hi n Hi l. Lo n Lo L dA n dA	Output 2 alarm is not fail-safe, and therefore should not be used for critical installations
	Digital output	On	on *	Modifiable through digital communications
AH	Auto/manual enable	Changeover locked out Changeover possible	Auto HAnd	Changeover locked out After lock-out instrument remains in existing operating mode- automatic or manual
CJC	CJC reference selection	Internal reference 0 °C external reference 45 °C external reference 50 °C external reference	Int 0C 45C 50C	Internal reference
Pb d	Proportional band display	°C or °F Linear input units Percentage	C-F Lin Pct	°C / °F Disappears if 'Sn' = 'Lin' or '.Lin' Appears if 'Sn' = 'Lin' or '.Lin'
PH-L	Proportional band scale factor (without tenths' precision)	10 to 1500°C 18 to 2700 °F 1 to 9999 units		Measurement range as product code Parameter appears only if 'Pb d' is configured as 'Pct'. Scale factor range is dependent on choice of linearisation and units

	Proportional band scale factor (with tenths' precision)	50.0 to 999.9 °C 90.0 to 999.9 °F 0.1 to 999.9 units		Set to configured measurement range span
† SU **	Self-tune on start-up	Enabled YES Disabled no	Enabled	
Cb O *	Cutback function	Automatic value (3x Pb) Auto Adjustable parameter HAnd	Automatic	

LINEAR INPUT (Option QLS)				
Act	Control action	Automatic vReverse Direct	rEv dir	Reverse (PV below SP fi heat)
Hi L	Measurement range upper limit (sensor break)	-999 to 9999 -99.9 to 999.9 (tenths' precision)		
Lo l.	Measurement range lower limit (sensor break)	-999 to 9999 -99.9 to 999.9 (tenths' precision)		
Fl	Input filter	0.01 to 99.99 ° or units		1 unit
Proc	Process scaling (straight line equation)	1. Scaling point 2. Scaling point	P1 P2	Input signals for scaling should be as close as possible to min & max of measurement range

CONFIGURATION ACCESS LEVEL / ALIBRATION		<i>These parameters appear only if 'Sn' is configured</i>		
ACCS	Parameter access in operator level	Hidden Read only Readable/alterable	HidE rEAd Altr	For security reasons, all critical parameters disappear in the operator level (see specific chapter)
CAL	Calibration procedure	Sub menu header 20mV reference 50mV reference CJC reference Pt1 00 reference Retrieve original factory calibration	---- 20.0 50.0 cjc rtd FAC	Calibration should only be undertaken by qualified personnel. The use of precision sources is essential (see specific chapter)
			Does not calibrate linear input	

Pre-configuration, parameter setting

A large number of parameters are installation-dependent, and as such only need setting once before commissioning. This setting should take place before connecting the instrument to the plant, e.g. at a bench. In addition, these parameters should, for security reasons, be removed from the operator's ACCESS menu (**HidE**).

WARNING

Never configure the instrument while it is controlling a process.

In the following paragraphs, some advice is given for parameter setting:

Proportional band: With the **Pb d** parameter, one can select whether the proportional band should be displayed in units or in percentage. If the percentage setting is chosen, the range is determined using the **PH-L** parameter, to which the percentage data refers. The value should be equal to the measurement range of the instrument.

ON/OFF controller: If the instrument is configured as an ON/OFF controller, the output hysteresis is set using the proportional band (**ProP**). All other control parameters are hidden from the parameter list.

Relative cool gain: This parameter (**rEL.C**) indicates the relationship between the heating and cooling performance of the controlled equipment. By this means, a special proportional band is defined for the cool channel, which is calculated from the value for the heat channel and the factor set in **rEL.C**. The parameter is set according to the ratio:

$$\mathbf{rEL.C} = \text{heat performance} : \text{cool performance}$$

Therefore the heating/cooling effectiveness values of the controlled equipment must be known or deduced. The parameter must be correctly set without fail before activating self-tuning, as tuning relies on this value for calculating the control parameters.

Cycle time: The cycle time of the switching outputs (**H c.t** and **C c.t**) should be set to high values (e.g. 20 seconds) if contactors are used, and to low values (e.g. 1 second for logic output) if thyristors are used.

Cutback

H cb and **L cb** are additional control parameters, which were developed by EURO THERM specifically for optimum start-up. Through their use, over- and undershoot can be avoided. (This is a normal occurrence in standard controllers when there is an excessive control deviation leading to integral saturation). At the same time rapid settling is guaranteed, as the controller provides full output until the cutback point is reached. Cutback works by moving the proportional band (**H cb** and **L cb**) to a determined point during an excessive control deviation.

To adjust cutback, both parameters are set in the first instance to match the proportional band. Thus cutback is cancelled (switched off). The data is always in display units and must therefore be recalculated in percentage for proportional band:

for **Pb** in units:

$$Hcb = Lcb = Pb$$

for **Pb** in %:

$$Hcb = Lcb = Pb(\%) \times \text{measurement range}/100$$

Now the process is started up with a large control deviation and the degree of over- and undershoot is registered.

Low cutback can be adjusted by a start-up attempt with an actual value smaller than the setpoint.

Low cutback: start-up attempt, actual value < setpoint

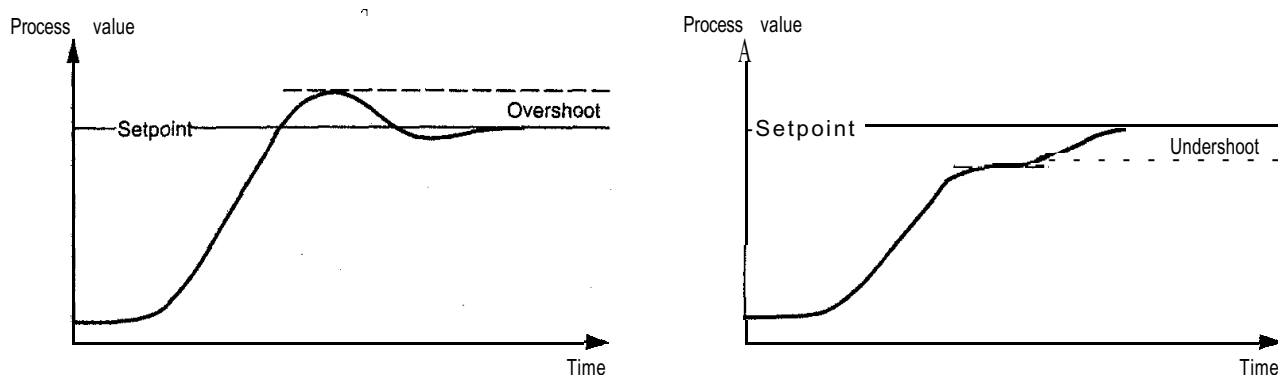

The cutback value is shifted from its previous setting equal to the proportional band by the amount of the over- or undershoot. Taking the proportional band value into account in calculating the low cutback, the setting rule is:

for **Pb** in units:

$$Lcb = Pb + \text{overshoot}$$

$$Lcb = Pb - \text{undershoot}$$

for **Pb** in %:

$$Lcb = Pb(\%) \times \text{measurement range}/100 + \text{overshoot}$$

$$Lcb = Pb(\%) \times \text{measurement range}/100 - \text{undershoot.}$$

The appropriate values for high cutback can be adjusted by a start-up attempt with an actual value greater than the setpoint (cooling).

High cutback: start-up attempt, actual value > setpoint

The setting rules for this are:

for **Pb** in units:

$$Hcb = Pb + \text{overshoot}$$

$$Hcb = Pb - \text{undershoot}$$

for **Pb** in %:

$$Hcb = Pb(\%) \times \text{measurement range}/100 + \text{overshoot}$$

$$Hcb = Pb(\%) \times \text{measurement range}/100 - \text{undershoot.}$$

With the parameter **Cb** 0, a fixed value can be set for both cutback points. The cutback points are then set to 3 times the proportional band value and both parameters are hidden.

PARAMETER ACCESS AND CALIBRATION

Parameter access protection

This menu defines the parameters which are modifiable at the operator level. The menu is only available when the configuration link/switch is closed. Here, each parameter is defined as to whether at the operator level it is:

- . 'readable and alterable' (**Altr**)
- . 'readable only, not alterable' (**rEAd**)
- . 'hidden' (**HidE**).

With the configuration link/switch closed, scroll down to the mnemonic **ACCS** using the **PAR** button.

By pressing the 'raise' button, the first parameter (**HiAI**) is called up. By using the 'lower' button access can be set. Pressing the raise button again acknowledges the setting and moves the selection on to the next parameter. Repeat this procedure until you have defined access for each parameter.

By operating the **PAR** button, you can leave the access menu at any time. If no buttons are pressed within five seconds, the menu times out automatically.

BUTTON OPERATION:	DISPLAY:
1. Instrument configuration switch in 'CONFIG' position.	
2. Depress PAR button until display shows:	A C C S
3. Depress 'raise' button, first parameter appears:	A l t r H i A I
4. Depress 'lower' button until desired access appears	H i d E H i A I
	r E A d H i A I
	A l t r H i A I
5. Depress 'raise' button to advance to next parameter Assign access for all parameters	A l t r L o A I

Figure 7.1 .1 Parameter access protection

Calibration

By virtue, of the drift-free design of the input circuit, it is normally not necessary to recalibrate the instrument after leaving the factory. Should an identifiable measurement error be detected, please note the following points:

On changing a thermocouple, the measured value can deviate (from the reading of the old one). This deviation can be compensated by changing the parameter **OFSt** Temperature differences between the sensor location and the point of desired temperature measurement are compensated by this as well. Differences between two side-by-side instruments are mainly due to the above-mentioned reasons and do not require recalibration.

If recalibration is really necessary, there are two ways of proceeding: default to the original factory calibration or field calibration of the instrument.

Factory calibration is stored in the non-volatile memory of the instrument, and can be retrieved at any time without the aid of calibration sources. For factory calibration, follow the instructions given in Figure 7.2.1, the instrument must be set to configuration mode by closing the configuration link/switch. Factory calibration must not be attempted while the instrument is controlling a process.

Field calibration of the instrument should only be performed by trained and qualified personnel. A precision calibration source is necessary for recalibration; it should be at least twice the accuracy of the instrument itself (precision of calibration source 0.1%). The calibration source must be equipped with an in-built CJC for type J thermocouples. In addition, appropriate type J compensating cable is required. For recalibrating the resistance thermometer input (RTD), a precision decade resistance box (5 decades, 0.1 W steps, 0.02% precision) and copper wire must be used.







BUTTON OPERATION:	DISPLAY:
1. Instrument configuration switch in CONFIG position.	
2. Depress PAR button until display shorts:	
3. Depress 'raise' or 'lower' button until lower display shows FAC:	
4. Depress 'raise' or 'lower' button:	
5. Depress 'raise' or 'lower' button:	
6. Acknowledge with the PAR button:	
7. After about 5 seconds the calibration procedure is completed	

Figure 7.2.1 Retrieving **factory** calibration

Calibration

Depending on the measurement range, different reference voltages must be calibrated in the instrument. The necessary references are listed in Figure 7.2.2 and must be calibrated in the sequence given in the table.

REFERENCE	MNEMONIC	MEASUREMENT RANGE INPUT		
		All thermocouples	RTD	Linearinput
1. 20.00mV	20.0	.	.	.
2. 50,000mV	50.0	.	.	.
3. CJC	CJC	.		
4. Pt100	rtd		.	

• = required calibration

NOTE: Calibration must be performed in the order given in the table

Figure 7.2.2: Reference voltages

Remove the instrument from the panel and place it on a laboratory bench. Close the configuration link/switch and allow the instrument to warm up for at least 30 minutes. Connect the appropriate reference voltage: for calibrating the CJC the connection must be made with compensating cable (CJC of calibration source equivalent to type J thermocouple at 0°C), all other references are connected with copper wire (wires must be of identical length). See Figure 7.2.3 for the recalibration procedure using the 20mV reference as an example.





BUTTON OPERATION:	DISPLAY:
1. Instrument switch in CONFIG position Connect calibration, source and set to appropriate value.	
2. Depress PAR button until display shows:	
3. Depress 'raise' or 'lower' button until appropriate reference appears:	
4. Depress PAR button once::	
5. Depress 'raise' or 'lower' button:	
6. Acknowledge with the PAR button:	
7. After about 5 seconds the calibrator procedure is completed. Select next reference to be calibrated and repeat procedure.	

Figure 7.2.3 Recalibration

linear input option

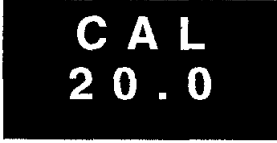
With option QLS, linear input signals (mV and process signals with an appropriate input adapter) can be connected to the input and conditioned according to a linear equation.

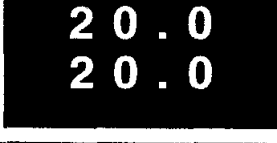
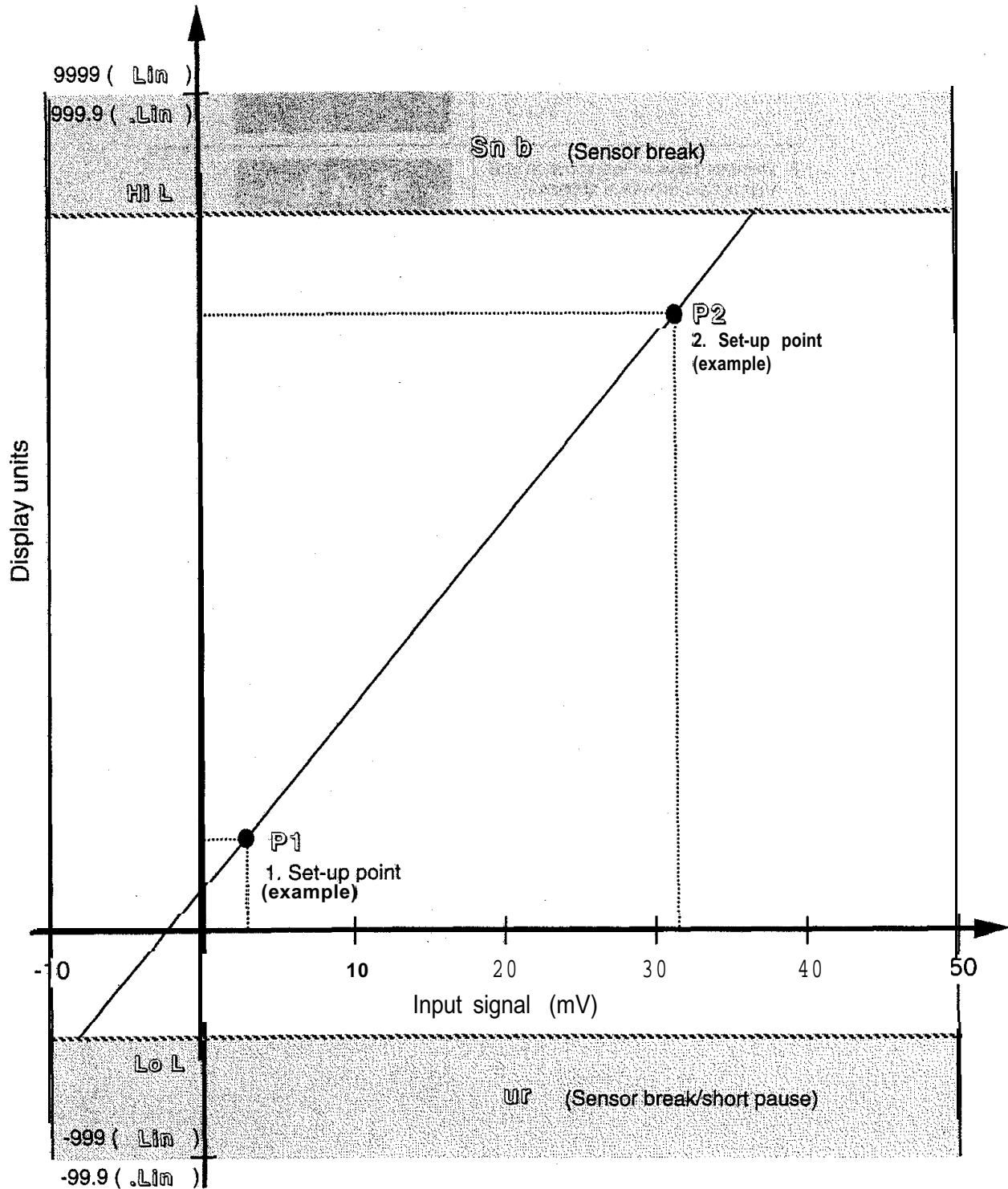

Figure 7.3.1 Linear input

PROGRAMMER/CONTROLLER

Programmer/controller - Function

Models 808 and 847 with option QLPS contain an in-built setpoint generator in addition to the controller function. This setpoint generator can produce a temperature/time profile with four segments. When the program is running, the current setpoint from the setpoint generator is fed to the control algorithm. The current setpoint is continuously shown on the lower display.

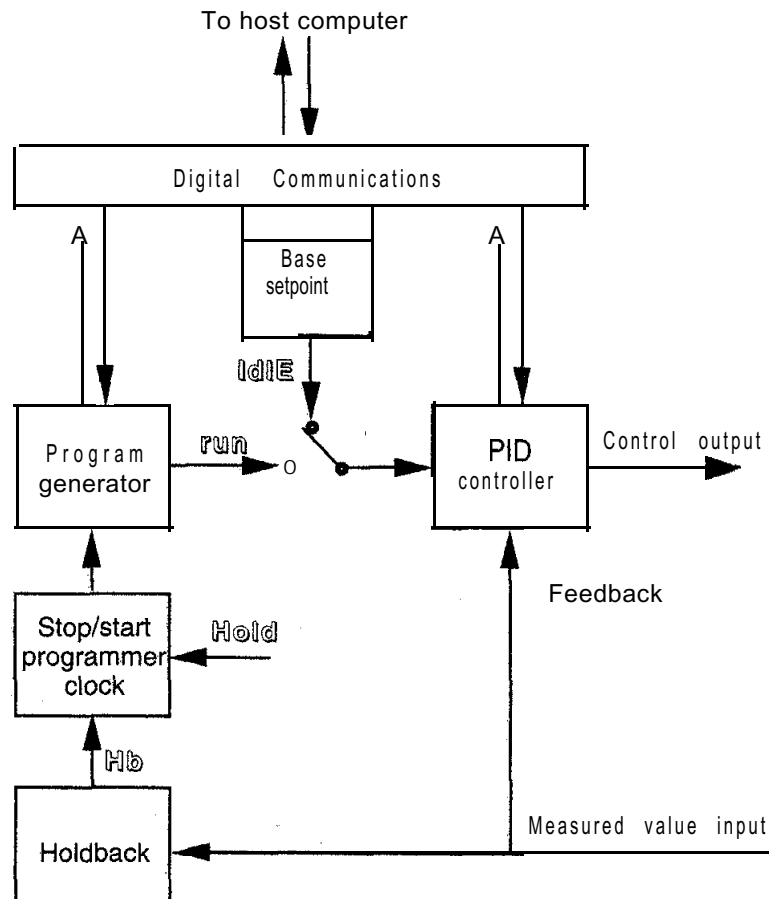

Figure 8.1.1 Conceptual block diagram of programmer/controller

The four segments are defined in the order: **Ramp 1, Dwell period 1, Ramp 2, Dwell period 2**, and are executed in succession. The number of program repetitions (up to 200, or continuously [Cont]) can be set with the LC parameter; at the end of dwell period 2 the program goes back to the beginning. When the program is running, the parameter is decremented and thus shows the repetitions remaining.

A **ramp** consists of a slope (linear gradient) and a target setpoint. The control setpoint increases or decreases at a linear ramp rate from the actual measured value until a specified target setpoint is reached. The relative positions of the actual measured value and the target setpoint determine whether the slope of the ramp is positive or negative. Parameters **r1** and **r2** express

the ramping rate in units per minute (0.01 to 99.99), parameters **L1** and **L2** the appropriate target setpoint in display units (adjustable over the configured measurement range, but not restricted by **SP H** and **SP L**). The starting setpoint for ramp 1 is always the current measured value (servo). Even during a program repeat, the starting setpoint is always set equal to the current measured value at the moment of reset.

In a **dwell period**, the target setpoint, which has been attained, remains unchanged for a fixed period. Both dwell periods are defined by their duration in minutes with parameters **d1** and **d2** (0 to 9999). When the program is running, these parameters display the time remaining in the active dwell period. If the parameter equals zero, the dwell period is skipped.

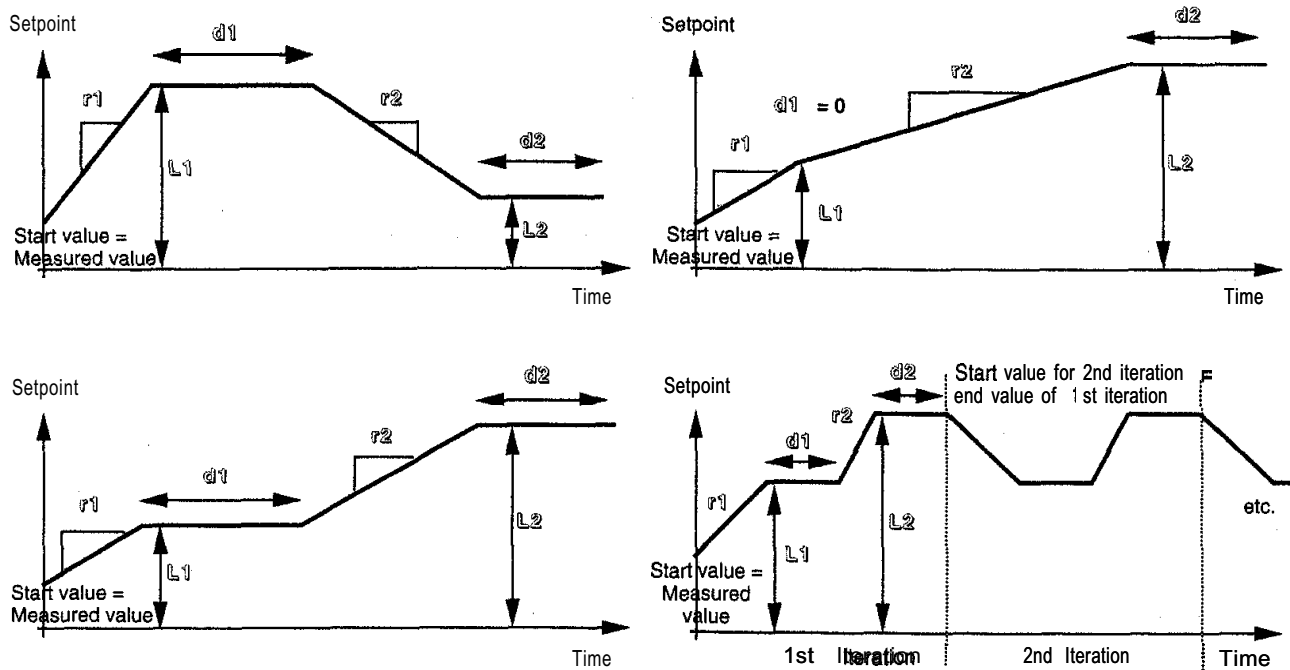

Figure 8.1.2 Program examples

Programmer/controller - States

The programmer/controller can be placed in three different states. Its state is determined by the parameter **Prog** with the values **IdIE**, **run** and **Hold**. An additional, non-selectable state is holdback (**Hb**), described later.

If the programmer/controller has been placed in the **IdIE** state, it operates as a simple controller with the setpoint shown on the lower display. An entered program is not executed.

In the **run** state, the program has been started and is executing. When started from the **IdIE** state, the program is always launched from the beginning, at the end of the program it returns to **IdIE**. The current running segment is displayed together with the configured unit, by depressing the **PAR** button once. A program which is running may be reset by selecting **IdIE**.

A program which is running (**run**) is halted by selecting **Hold**. The program generator stops

the program on the current setpoint. From the **Hold** state, the program can be continued (run) or reset (**Idle**).

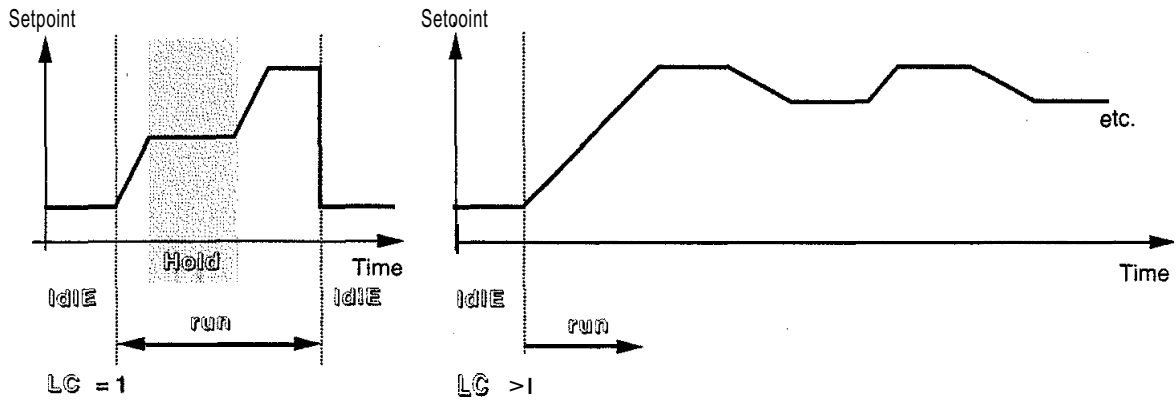
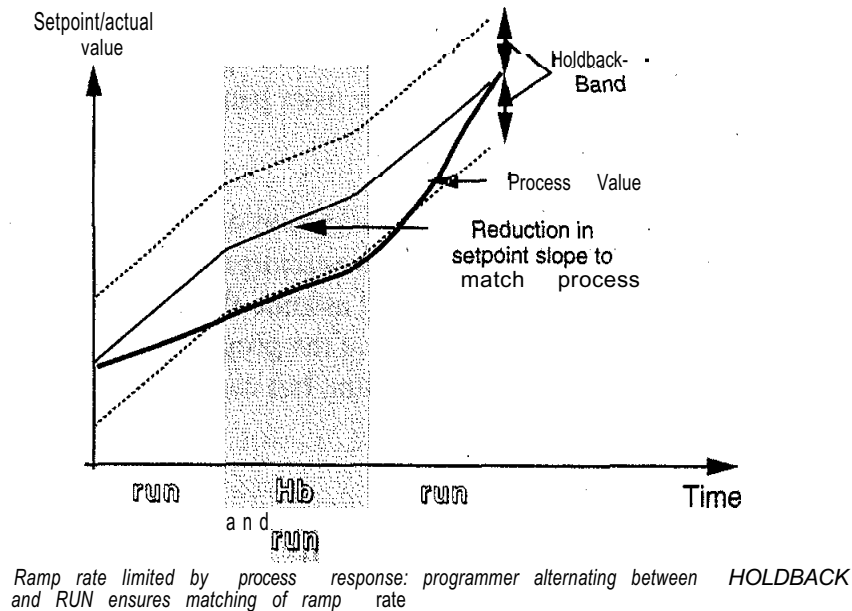

Figure 8.2.1 Programmer/controller states

Programmer/controller - Holdback

The holdback state (**Hb**) is a special case of **Hold**. It is activated of its own accord by the programmer/controller and cannot be selected by the user. The Hb parameter allows the user to set the difference tolerated between the current setpoint and the actual value while the program is running. If this difference is exceeded, the program generator halts itself in order for the process value to catch up with the program setpoint. Figure 8.3.1 shows the holdback mode of operation. A ramp which is too steep for the system response is reduced to the maximum possible rate for the process by the effect of holdback. In a dwell period the time-base is halted. If the difference between setpoint and actual value is again smaller than **Hb**, the program is continued. The parameter can be altered within the limits of the measurement range.

To switch off holdback, set the parameter to a very high value.



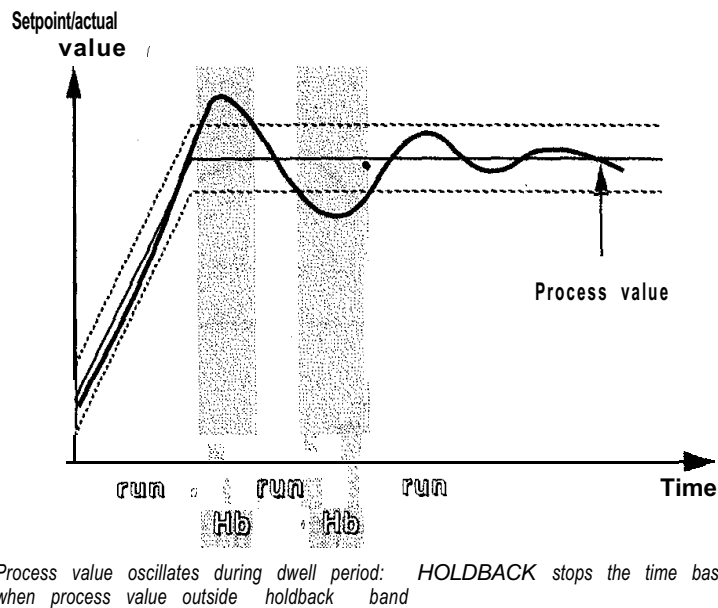

Figure 8.3.1 Holdback

Programmer/controller - Setpoint programming

The **state** of the programmer can be modified in three ways. All three have the same priority and the last action from any of them is acted upon:

- . Via the digital communications board, by modifying the status word, see special Communications Handbook for Eurotherm Controls 800 series (Part no. HA020161).
- . Via the front panel pushbuttons, by choosing the parameter **Prog** and selecting the parameter value (**Idle**, **run** or **Hold**). Rear terminals 16 & 17 must be bridged during this time, otherwise the instrument will immediately go into **Hold** when the program starts. If the programmer/controller is placed from **Idle** into **Hold** via the front panel pushbuttons, the program is both started and then immediately halted.

Via the rear terminals 16 & 17 as shown in the description of the connecting terminals (Figure 2.3.8). If the instrument is configured as a programmer/controller, these terminals no longer have the function of front panel lock-out, but assume the function of setpoint programming. Figure 8.4.1 shows the run sequence. Note that the programmer/controller goes into the **Idle** condition only after the completion of a program, but cannot be placed there using the rear terminals.

Programmer/controller - Annunciators

The LED beacon **R** in the upper section of the display panel indicates the current state of the programmer/controller:

- . LED off ⇒ **IdIE**
- . LED on * **r u n**
- . LED flashing ⇒ **Hold** or **Holdback**

Programmer/controller - Parameter modification

Modifications to the parameters specific to a particular program are differently interpreted according to the state of the programmer/controller.

In the **IdIE** state, all the parameters can be modified, the modification is permanent.

In the **run** state, the parameters specific to the program, **LC, rl, L1, dl, r2, L2** and **d2**, cannot be modified (including by digital communications). A modification is possible to the **Hb** parameter, the modification is permanent.

In the **Hold** state, the parameters specific to the program, **LC, rl, L1, dl, r2, L2** and **d2**, can be modified (including by digital communications), the modification is, however, not permanent and is valid only for the current iteration of the program. A modification is possible to the **Hb** parameter, the modification is permanent.

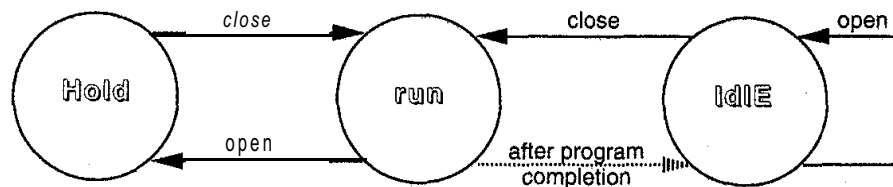

A. Program control through opening and closing of rear terminals



B. RUNIHOLD-Sequence while program is running

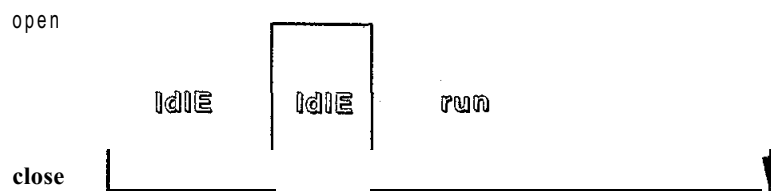

C. Restarting program after completion of previous program

Figure 8.4.1 Use of rear terminals for program control

Ending a program

At the end of a program, the programmer/controller returns to the **Idle** state and switches back to the normal control setpoint (SP). According to the target setpoint of ramp 2 and the normal control setpoint, different conditions ensue. The setpoint can be modified as in normal closed-loop operation whilst the program is running and influences the end of the program. Figure 8.5.1 shows a combination of all possibilities.

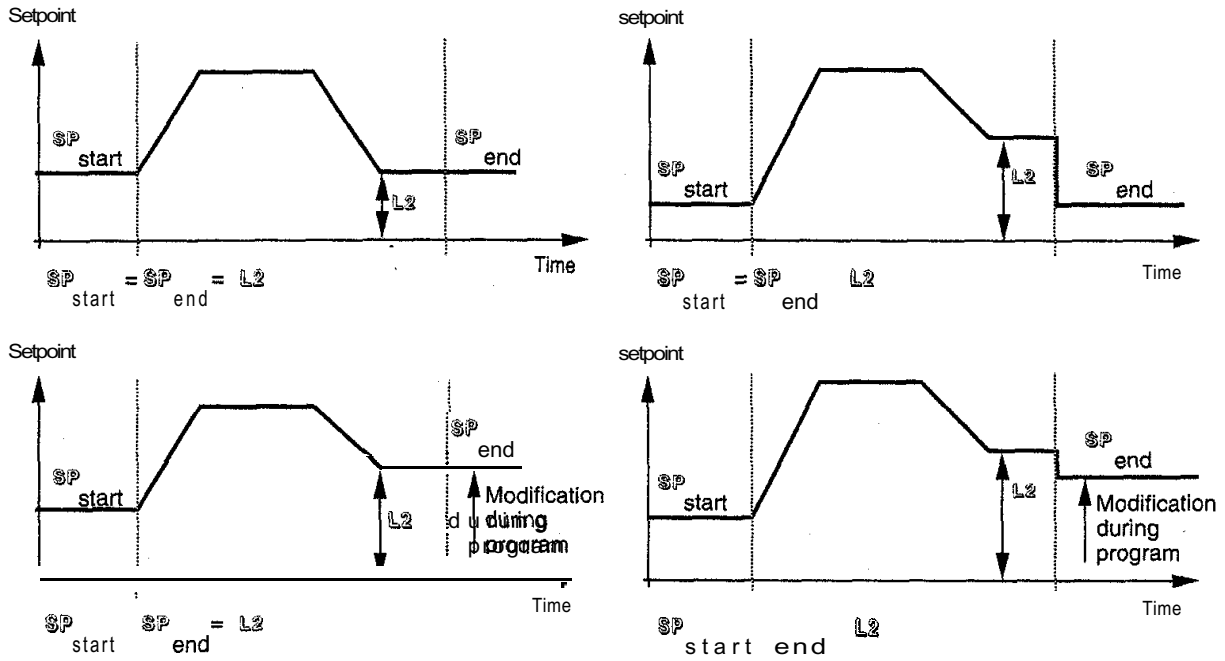
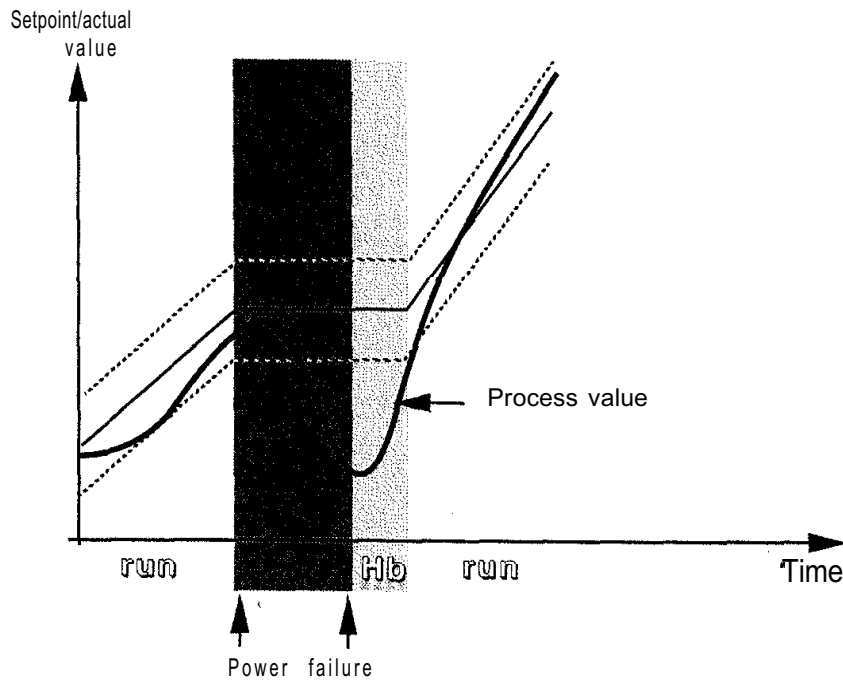

Figure 8.5.1 Methods of ending a program

Program recovery following loss of power

All the instrument parameters are stored in non-volatile memory. When power is lost, the current point in the program is also stored in the memory. When power is restored, the programmer/controller resumes the program in the appropriate segment at the point reached at the moment of interruption, as soon as the process value re-enters the holdback band.



A. Loss of power during ramp

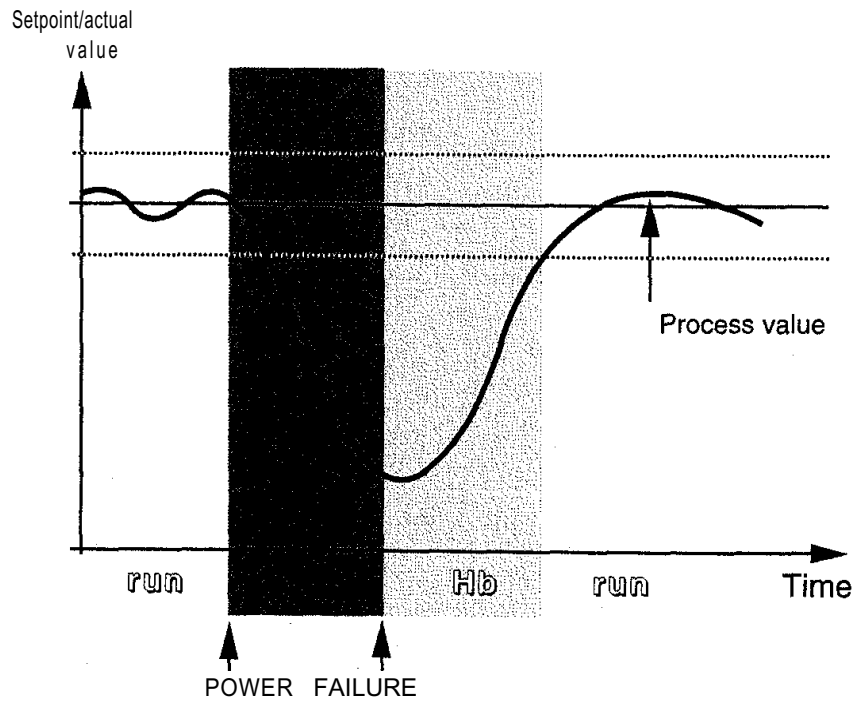

B. Loss of power during dwell period

Figure 8.6.1 Program recovery following loss of power

SELF-TUNING

Self-tuning - General

808 and 847 controllers have in-built self-tuning as a standard feature, which can be activated by the user on demand. According to a special procedure, the instrument examines the process reaction curve and calculates by means of a complex computer algorithm the optimum control parameters, using the data measured during the procedure. The parameters thereby obtained after successful tuning are automatically set into the instrument. Control parameters can be adapted in this way at any time for new or modified process reaction curves. It is not necessary to pre-adjust the control parameters before tuning, this is an important advantage over customary procedure.

Note: The adjustment procedures used here apply thermal shocks; in sensitive systems damage can occur. The adjustment procedure relies on correct configuration of the controller for the process and can only work correctly if these pre-conditions are met.

If the instrument is used as a heat/cool controller with a non-linear cooling method (e.g. water cooling over 100 °C) on output 2, the latter must be configured correctly (parameter **OP 2 = H20**), otherwise the cooling system can be damaged when self-tuning is activated.

Self-tuning works by two different procedures which are automatically selected:

- . Tune from ambient (measured value far from setpoint)
- . Tune from setpoint.

A self-tune procedure from ambient is performed if, on activating self-tuning, the measured value and the chosen tune setpoint are not near one another. This **can** apply to a normal heat-up or cool-down condition (when the cool channel is connected).

A self-tune procedure from setpoint is performed if, on activating self-tuning, the measured value and the setpoint are approximately equal, e.g. when the process reactioncurve has converged. This procedure can be used for post-tuning the curve in the finalised control set-up.

Both types of self-tuning calculate the following control parameters:

- . **Prop** Proportional band
- . **Int.t** Integral time constant
- . **der.t** Derivative time constant

In addition, the tune from ambient operation calculates the parameters:

- . **H cb** High cutback (start-up optimisation)
- . **L cb** Low cutback (start-up optimisation)

Note: The adjustment procedure does not calculate the relative cool gain of a possible cool channel. For correct parameter calculation using self-tuning, this ratio must be set in parameter **rEL.C** before activating self-tune. On tuning for a process which must be predominantly cooled (endothermic process) to achieve control, the procedure calculates the proportional

band for the cool channel. Here, too, a correct setting of `rEL.C` is necessary before activating self-tune.

Self-tuning - Activation

Self-tuning can be activated under the following conditions:

- Operator level (not in configuration level)
- . Automatic operating mode (closed loop)
- . PID control algorithm (**Pid**, **r SP**, or **Prog**)

In the following circumstances, self-tuning is halted or overridden:

Tuning is halted when the controller is switched over from automatic to manual. It automatically begins afresh when switched back to closed-loop (if not switched off in between times).

In a power outage the process is interrupted. If automatic tuning is configured to take place on application of mains power, tuning re-starts when the power supply returns.

If the programmer/controller is executing a program, tuning cannot be activated during a ramp. The program must be reset beforehand (**Idle**) or halted (**Hold**).

If the instrument is configured as a PID controller with ramped setpoint (**r SP**), the tuning procedure overrides the start-up ramp.

Self-tuning can be activated with two different parameters, the tuning setpoint can be adjusted for about one minute after the start.

With the parameter **tunE**, the user can trigger an immediate tune. The parameter values on and **OFF** serve to activate and display the tuning procedure.

With the parameter **t SU** (start-up) a one-off tune is selected the next time power is applied to the instrument. If the parameter is set to **YES**, no successful tune operation has taken place but one will automatically be launched the next time power is applied to the instrument. After a successful tune operation, this parameter reverts to **no** of its own accord.

Self-tuning - Operation

The diagrams on the following pages illustrate the self-tuning operation. In order to achieve good control results, the actual value should be broadly stable before the start. The algorithm functions even if the actual value is unstable but it evaluates this change as part of the process reaction curve.

During the course of the operation, the annunciation **tunE** flashes in the lower display. During this period, do not change any of the instrument parameters. The tuning operation is finished when the annunciation **tunE** no longer flashes in the lower display. The user can abort self-tuning at any time by setting the parameter **tunE** to **OFF**.

Tune from ambient:

The desired setpoint for tuning can be adjusted with the raise or lower buttons for about one minute. During this time the output level is reset to zero. Also at this time the influence of adjacent zones on the specific zone is observed and compensated for in the algorithm. After this the actual tuning operation begins, the instrument commands heat (if setpoint is greater than actual value) or cool (if setpoint is smaller than actual value) with maximum output strength. From the start-up process reaction curve, a fictitious setpoint (CP), which lies somewhat below (above) the setpoint to be tuned in order to exclude overshoot (undershoot). On reaching this value, the output is switched off and oscillations are forced through repeated switching (see diagram).

The control parameters are then calculated from the recorded data of the reaction curve (delay time, heating rate, period and amplitude of the forced oscillation,...) and are stored independently in the instrument. The tuning operation is successfully completed.

Note: If the cool channel output is configured for non-linear cooling (e.g. water cooling over 100 °C, H2O) the maximum output level during cooling is only 20% in order to avoid excessive thermal shocks through non-linearity.

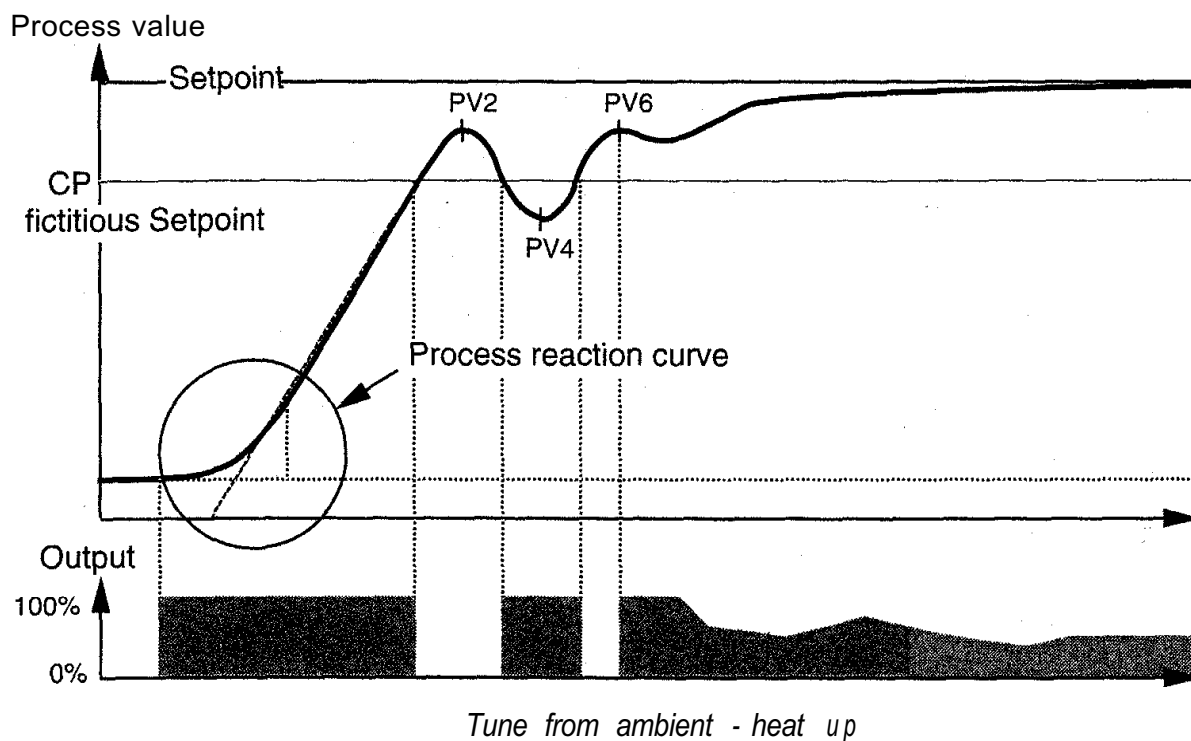
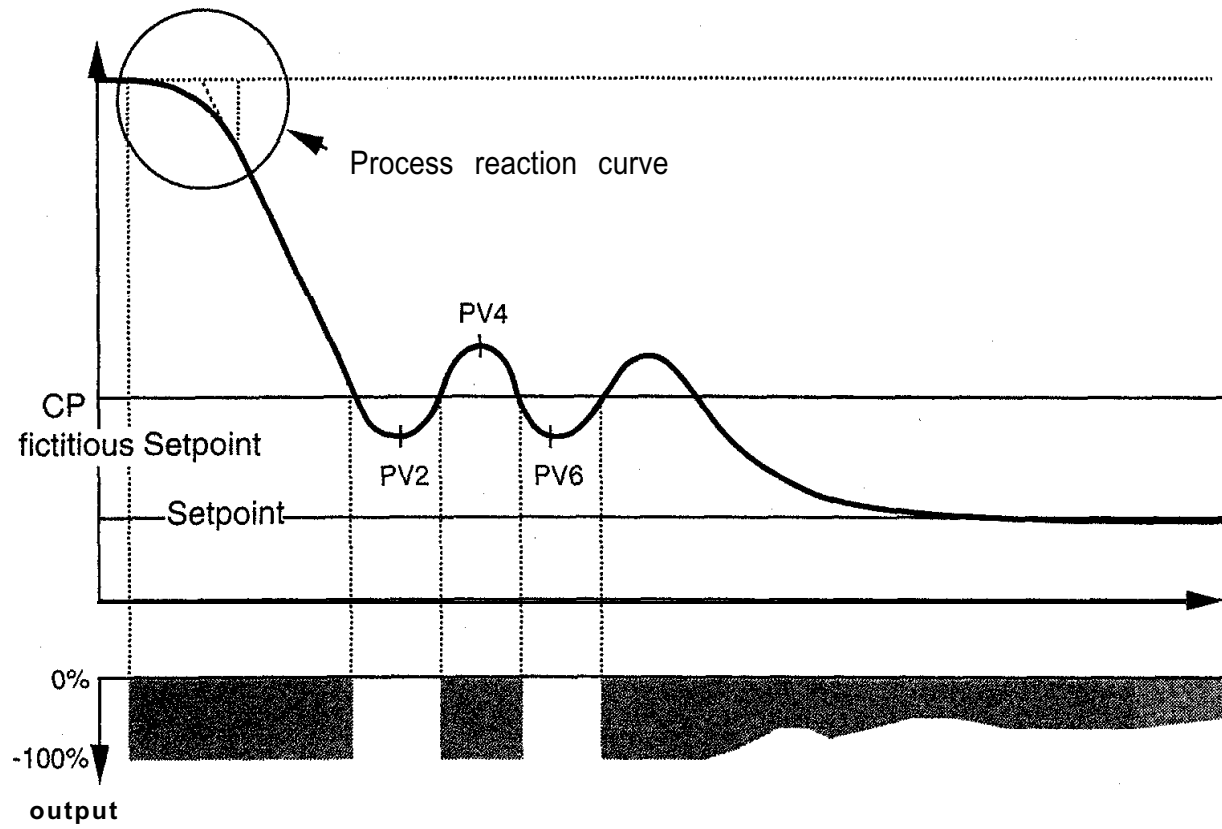

Figure 9.3.1 a Tune from ambient

Process value



Tune from ambient - cool down

Figure 9.3.1 b Tune from ambient

Tune from setpoint:

After initiating a self-tune from setpoint, the output power is fixed for one minute at the original value. If during this time a new setpoint is set, the instrument automatically switches to tuning from ambient. Again at this time, the influence of adjacent zones on the specific zone is observed and compensated for in the algorithm. After this, both outputs are switched off for a short while and the process reaction curve is observed. In either the case of an exothermic process (heat removal) or an endothermic process (independent heat supply), oscillations are induced at the fictitious setpoint (CP) by switching on the heat or cool channel.

Here too, the control parameters are calculated from the data acquired from the reaction curve and are stored independently in the instrument. The high and low cutback levels are not calculated, but are checked to ensure that they do not lie within the proportional band. Should this be the case, they are moved out to the edge of the proportional band and therefore become inactive. The tuning operation is successfully completed.

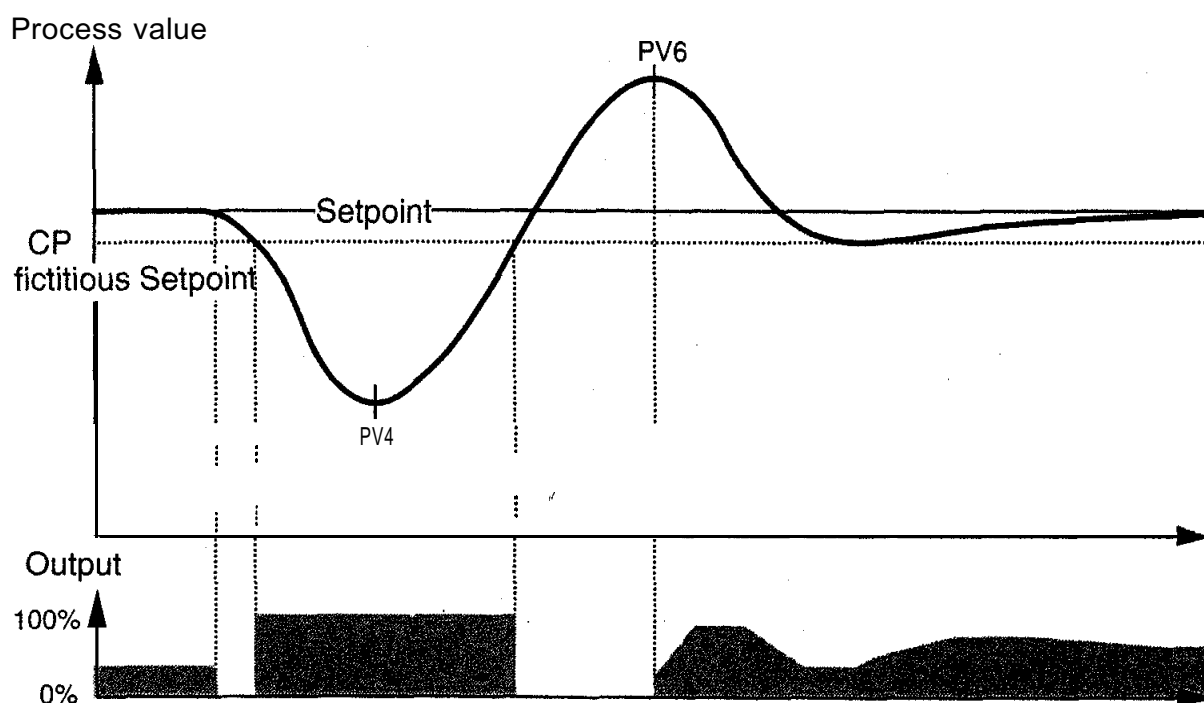

Tune from Setpoint - endothermic process

Figure 9.3.2a Tune from setpoint

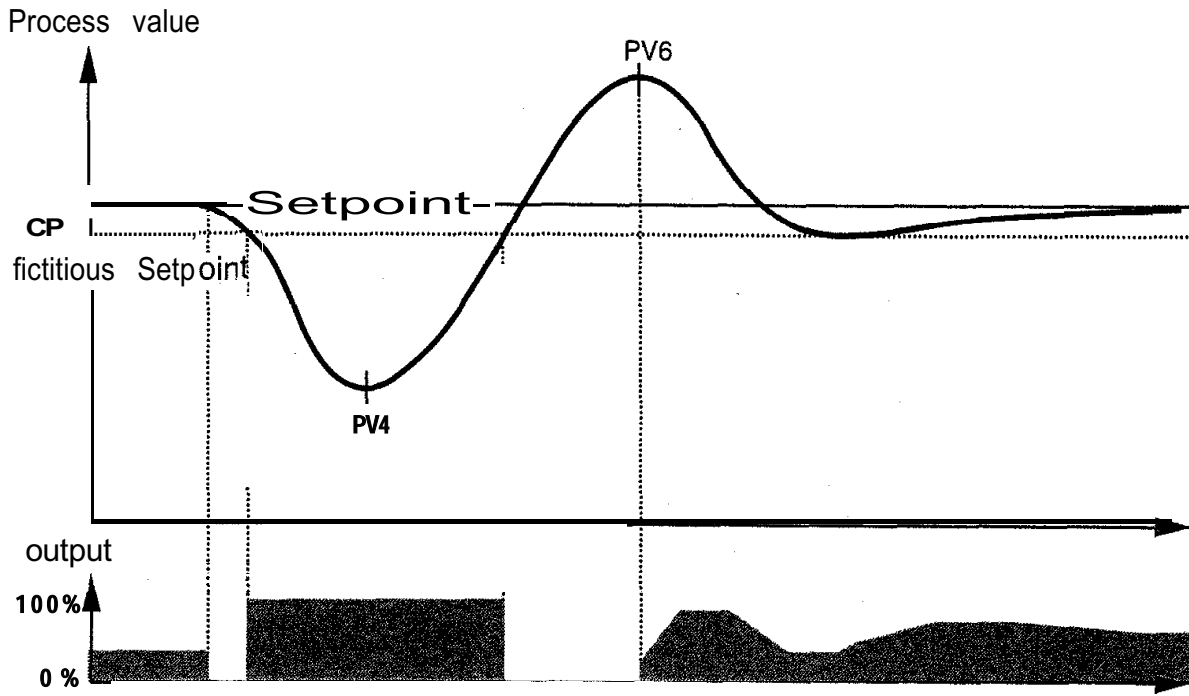

Tune from Setpoint - endothermic process

Figure 9.3.2b Tune from setpoint

Self-tuning - Abort conditions

In some cases, the self-tune routine aborts spontaneously due to external influences in the process being tuned for by the instrument.

In a heat-only controller, this is the case when, for example, through the influence of an adjacent zone, the process is heated up to the setpoint without its own heat source. The tuning algorithm recognises such a case and aborts the tune of its own accord after a time (depending on the process reaction). Although the parameters are calculated from the data acquired up to that point, an incorrect adjustment is possible.

The same case applies for a heat/cool controller; here too parameters are still calculated, although a complete tune has not been performed.

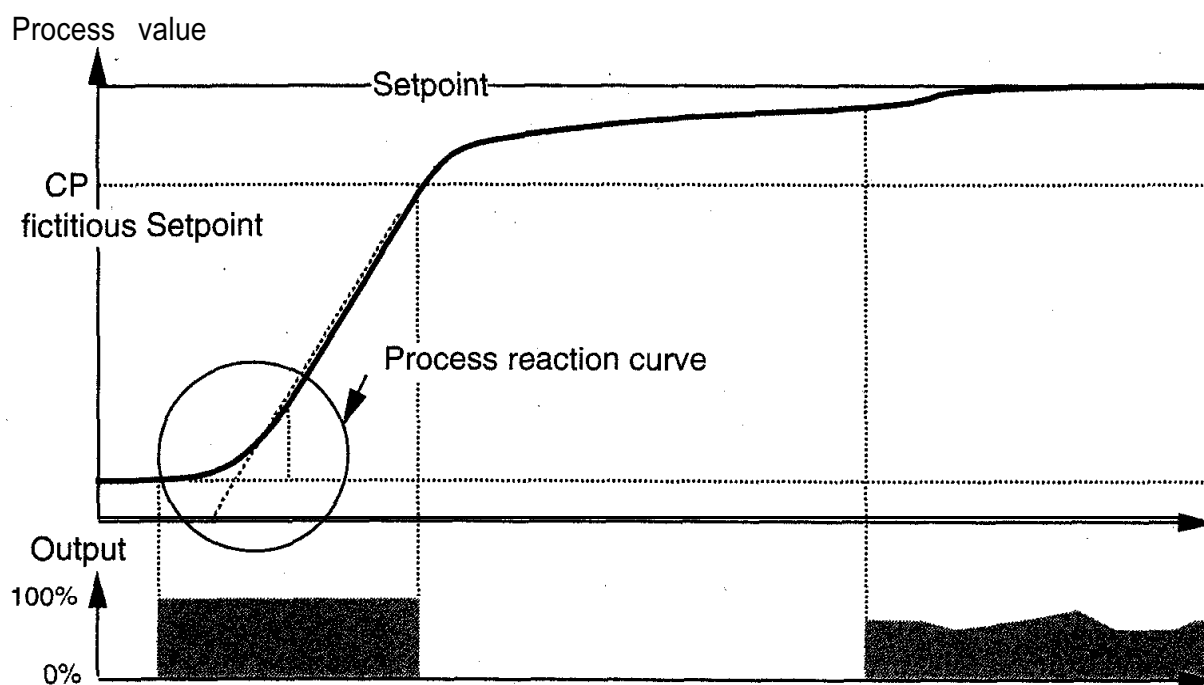

Tune from ambient - heat only, abort

Figure 9.4.1 a Self-tuning, abort

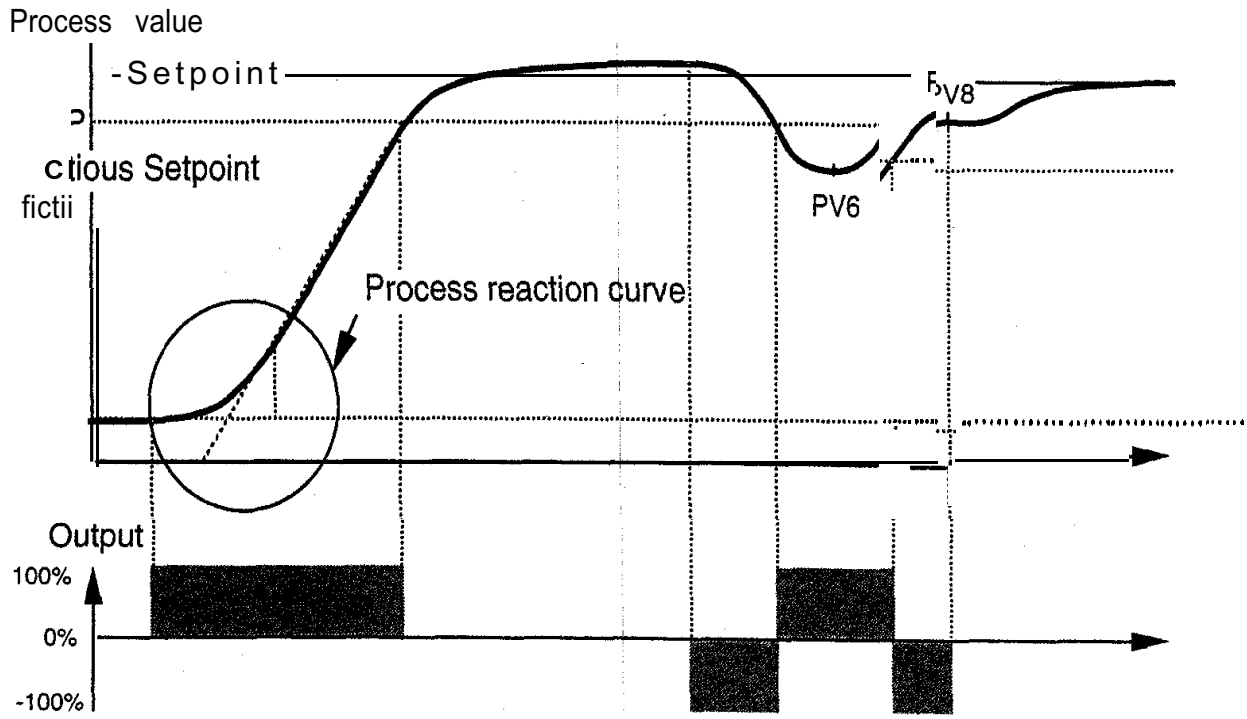

Tune from ambient ■ heat/cool, abort

Figure 9.4.1 b Self-tuning, abort

INSTRUMENT REGISTER

On the following pages is an instrument register for models 808 and 847 digital controllers. Record data here for each individual instrument. In the parameter tables, up to three different parameter adjustments can be recorded.

Instrument	Serial No.	Year	Month	Software version

Basic Instrument	Output modules output 1	output 2	output 3	Comms	Input Adapter	Special Functions
808/847						

Linearisation Type	Measurement Range	Display Units	Output configuration output 1	output 2	output 3
u	u	u	u	u	u

Calibration code for linear input:

Input Signal			Measurement range		
Min.	Max.	Units	Min.	Max.	Units
		mV, V, mA			

Register

Mnemonic	Parameter			
LOWER PARAMETER LEVEL				
SP	Setpoint			
none	Output level (Manual only)			
C or F	Display units (Display only)			

PROGRAMMER/CONTROLLER (Option QLPS)

Prog	Programmer/controller state (display & select)			
SP	Base setpoint			
tenE**	Activate self-tuning			
LC	Loop counter			
r1	1st ramp rate			
L1	1st target setpoint			
d1	1st dwell time			
r2	2nd ramp rate			
L2	2nd target setpoint			
d2	2nd dwell time			
Hb*	Holdback (band)			

OUTPUT POWER LIMITS

H PL	Max. power output			
SnbP	Sensor break power output			

Measured value input

OFSt	Calibration offset			
C F	°C/°F unit selection			
Sn	Sensor linearisation select			

DIGITAL COMMUNICATIONS

Addr	Instrument address			
bAud	Baud rate			

Alarms

Hi Al	Full-scale high alarm			
Lo Al	Full-scale low alarm			
d Al	Deviation alarm			

CONTROL PARAMETERS

ProP	Proportional band			
Int.t	Integral time constant			
dEr t	Derivative time constant			
rEL.C	Relative cool gain			
H c.t	Heat cycle time			
c c.t	Cool cycle time			
H cb	High cutback start-up optimisation			
L cb	Low cutback start-up optimisation			

Mnemonic	Parameter			
CONTROL PARAMETERS				
ProP	Proportional band			
Int.t	Integral time constant			
dEr.t	Derivative time constant			
rEL.C	Relative cool gain			
H c.t	Heat cycle time			
C c.t	Cool cycle time			
H cb	High cutback start-up optimisation			
L cb	Low cutback start-up optimisation			
SETPOINT LIMITS				
SPH	Setpoint high limit			
SPL	Setpoint low limit			
ALARM 1 OUTPUT				
HAO	Full-scale high alarm			
LAO	Full-scale low alarm			
dAO	Deviation band alarm			
INSTRUMENT CONFIGURATION				
idno	Identification number			
Ctrl	Control algorithm			
SPrr	Setpoint ramp rate			
OPI	output 1 (Hardware configuration)			
OP2	output 2 (Hardware configuration)			
AH	Automatic/manual enable			
CJC	Cold junction compensation			
Pb d	Proportional band display			
PH-L	Proportional band scale factor			
t su**	Tune on start-up			
Cb O**	Cutback operation			
LINEAR INPUT (Option QL...)				
Act	Control sense			
Hi L	Measurement range upper limit (sensor break)			
Lo L	Measurement range lower limit (sensor break)			
Fil	Input filter			

* From software version 02.00 **From software version 03.00

SUPPLEMENTS RELATING TO 809/849 VALVE POSITIONER CONTROLLERS

The dimensions, technical data, operation etc. are equivalent to the 808/847 controller series and can be taken from the appropriate chapters of this manual.

Further information is contained in the 809/849 series.

Valve positioner controller output (motor open/close)

Relay output (VPR) or triac output (VPT)

More (open) Terminals 1& 2

Less (close) Terminals 3 & 4

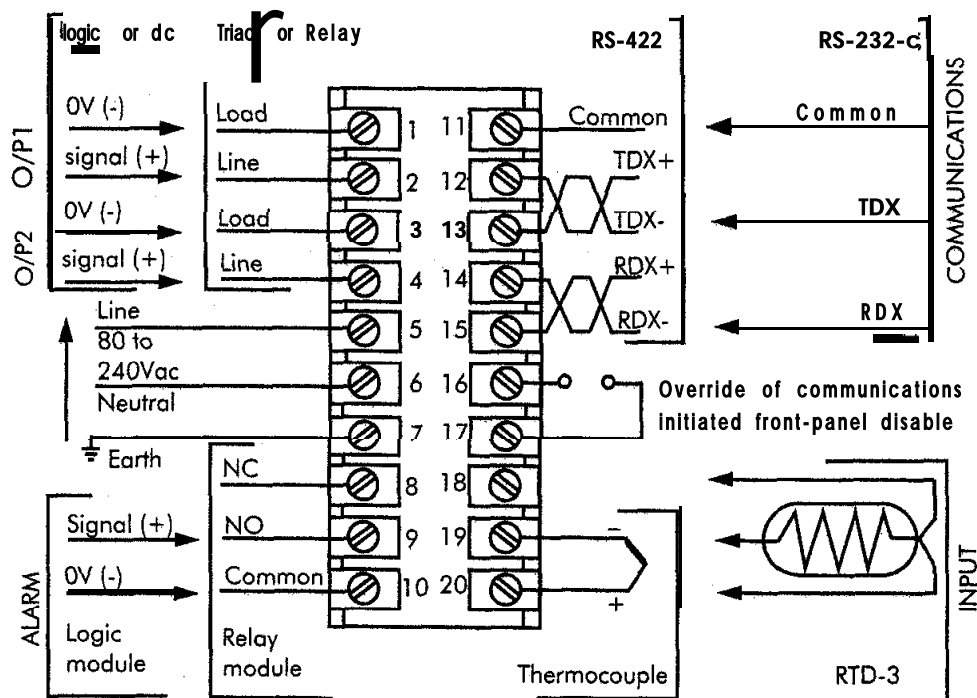

Figure 10.1 Terminal allocation for valve positioner controller

Additional parameters for valve positioner controller

You will find general parameters for the 809 in Chapter 6.3, parameter list.

In addition, the following control parameters (see Figure 6.3.2) may be accessed and modified:

Display	mnemonic	Parameter	Adjustable range	Function
tt	TT	Motor travel time	0.1 to 240s	Motor travel time
ct	TM	Cycle time	0.1 to 240s	Output cycle frequency (periods for ON and OFF)
inrt	TN	Motor inertia time	0.000 to 1 .0s	Inertia (motor inertia time)
blSh	BK	Motor delay time (mechanical backlash)	0.0 to 20% of motion range	Mechanical backlash

Adjustment note: Motor travel time, - use the value from the manufacturers' data sheet or measure the travel time using manual mode. The cycle time must be very much shorter than the motor travel time (<5%).

The following configuration parameters (see Section 6-7) are different

Display	Parameter	Adjustable range	Comments
Ctrl	Control algorithm	On/off Valve positioner Valve positioner with ramp to SP Valve positioner with SP programming	On.Of vALv rSP Prog Available only if option QLPS installed

The parameters for outputs 1 & 2 in Section 6-7 are not applicable as they are not used in the valve positioner controller.

Self-tuning for valve positioner controller

Models 809/849 valve positioner controllers incorporate self-tuning as a standard feature. The fundamental function of self-tuning, as well as its operation and launching, are essentially identical to that of the 808/847. You will find an explanation of this in Chapter 9 of this manual.

Please note the following difference: as the valve positioner controller operates with a PI algorithm, only the proportional band (**ProP**), integral time constant (Int.t) and if necessary, cut-back parameters are calculated, the derivative time constant is not applicable. To launch tuning, control algorithm type PI must also be configured (**vALv**, **r SP** or **Prog**).