

*Taken from a scanned copy of "Lectures on Chemical Reaction Networks," given by Martin Feinberg at the Mathematics Research Center, University of Wisconsin-Madison in the autumn of 1979.*

## LECTURE 2: REACTION NETWORKS, KINETICS, AND THE INDUCED DIFFERENTIAL EQUATIONS

In the first three sections of this lecture we'll make precise some of the ideas that were introduced casually in Lecture 1: Section 2.A contains our definition of a reaction network along with a small amount of auxiliary terminology. In Section 2.B we introduce the notion of a kinetics for a network, and we discuss mass action kinetics as the archetypical example. In Section 2.C we indicate in vectorial terms how a reaction system — that is, a reaction network endowed with a kinetics — induces a system of differential equations.

In Section 2.D we begin to examine some elementary connections between solutions to the differential equations for a reaction system and the structure of the underlying reaction network. These connections are hardly deep, but our awareness of them will help set the stage for the statement of substantive theorems in the next lecture.

Our discussion in Section 2.E is intended to illustrate how the mathematical framework erected in Sections 2.A-2.D is sufficiently broad as to embrace certain "open" reactors which, unlike the "closed" reactor depicted in Figure 1.1, exchange matter with the external world. The basic idea is that the influx and efflux of species can be taken into account by incorporating in a reaction network certain "funny" reactions like  $A \rightarrow 2A$ ,  $0 \rightarrow A$  ("zero reacts to A") or  $A \rightarrow 0$  ("A reacts to zero"). The discussion in Section 2.E should make clear not only why it makes sense to study seemingly peculiar reaction networks but also why it is essential that we do so.

### 2.A. Reaction Networks

Before placing on record our definition of a reaction network I want to recall and expand upon some ideas discussed at the end of Lecture 1. We shall regard a network to be specified by its set  $\mathcal{S}$  of species, by its set  $\mathcal{C}$  of complexes, and by a "reacts to" relation  $\mathcal{R}$  that indicates

how the complexes are joined by reaction arrows. Recall that the complexes of a network are just the entities that appear at the heads and tails of the reaction arrows — A, 2B, A+C, D and B+E in network (1.1). Recall also that, in the sense of the discussion at the end of Lecture 1, we regard the complexes to be vectors in  $\mathbb{R}^{\mathcal{S}}$ . (In particular, they lie in  $\overline{\mathbb{P}}^{\mathcal{S}}$ .) Thus, it makes sense to add two complexes, to subtract one complex from another, to multiply a complex by a number, and to take the scalar product of a complex with any other vector of  $\mathbb{R}^{\mathcal{S}}$ . Moreover, it makes sense to speak of the support of a complex. For example,  $\text{supp}(A+B) = \{A, B\}$ ,  $\text{supp}(2B) = \{B\}$ ,  $\text{supp}(A) = \{A\}$ , and so on. Loosely speaking, the support of a complex is just the set of species that "appear in" that complex. We shall always use symbols like  $y$ ,  $y'$  or  $y''$  to designate complexes in a reaction network.

Definition 2.1.\* A chemical reaction network consists of three sets:

- (i) a finite set  $\mathcal{S}$ , elements of which are called the species of the network.
- (ii) a finite set  $\mathcal{C}$  of distinct vectors in  $\overline{\mathbb{P}}^{\mathcal{S}}$  such that

$$\bigcup_{y \in \mathcal{C}} \text{supp } y = \mathcal{S}.$$

Elements of  $\mathcal{C}$  are called the complexes of the network.

- (iii) a relation  $\mathcal{R} \subset \mathcal{C} \times \mathcal{C}$  such that

- (a)  $(y, y) \notin \mathcal{R}$ ,  $\forall y \in \mathcal{C}$ .
- (b) For each  $y \in \mathcal{C}$  there exists a  $y' \in \mathcal{C}$  such that  $(y', y) \in \mathcal{R}$  or such that  $(y, y') \in \mathcal{R}$ .

Elements of  $\mathcal{R}$  are called the reactions of the network. For each  $(y, y') \in \mathcal{R}$  we say that complex  $y$  reacts to complex  $y'$ , and we write the more suggestive  $y \rightarrow y'$  in place of  $(y, y')$  if and only if  $y$  reacts to  $y'$ . The vector  $y$  [resp.,  $y'$ ] is called the reactant complex [product complex] of the reaction  $y \rightarrow y'$ .

---

\*The definition of a reaction network given here is similar to but a little more restrictive than that given by Horn and me in [FH2].

Example. For network (1.1)

$$\mathcal{S} = \{A, B, C, D, E\}$$

$$\mathcal{C} = \{A, 2B, A+C, D, B+E\} \subset \overline{\mathcal{P}}^{\mathcal{S}}$$

$$\mathcal{R} = \{A \rightarrow 2B, 2B \rightarrow A, A+C \rightarrow D, D \rightarrow A+C, D \rightarrow B+E, B+E \rightarrow A+C\}.$$

Remark 2.1. The restriction imposed in item (ii) of Definition 2.1 merely requires that each element of  $\mathcal{S}$  "appears in" at least one complex; that is,  $\mathcal{S}$  contains no superfluous species. The conditions imposed in (iii) assert, first, that no complex reacts to itself and, second, that no complex is "isolated": each element of  $\mathcal{C}$  is the product complex of some reaction or is the reactant complex of some reaction. (A complex can, of course, be the product complex for one reaction and the reactant complex for another.)

Remark 2.2. We shall reserve the symbol  $n$  to denote the number of complexes in a given network.

Remark 2.3. The component  $y_{\delta}$  (corresponding to species  $\delta \in \mathcal{S}$ ) of the vector  $y \in \mathcal{C}$  is usually called by chemists the stoichiometric\* coefficient of species  $\delta$  in complex  $y$ . For example, in the complex  $A+C$  of network (1.1) the stoichiometric coefficient of  $A$  is one, the stoichiometric coefficient of  $C$  is one, and the stoichiometric coefficients of  $B$ ,  $D$ , and  $E$  are zero. In the complex  $2B$  the stoichiometric coefficient of  $B$  is two, and the stoichiometric coefficients of  $A, C, D$  and  $E$  are zero. For  $y \in \mathcal{C}$  we note that  $\text{supp } y$  is the set of all species with non-zero stoichiometric coefficient in the complex  $y$ .

---

\* Ugly though it is, the word "stoichiometry" has come to occupy an important place in the vocabulary of chemists and chemical engineers. Rutherford Aris, who knows about these things, traces the word back to its Greek roots — in fact, back to Plato's discussion of the material elements. He (Aris, not Plato) asserts, "Stoichiometry literally means the measurement of the elements but the word is commonly used to refer to all manner of calculations regarding the components of a chemical system... Stoichiometry is essentially the bookkeeping of the material components of the chemical system." [ A ] We shall use the word in this last sense.

## 2.B. Kinetics

We introduced the notion of a kinetics for a reaction network in an informal way in Lecture 1. Here we shall be a little more precise about what we mean.

Definition 2.2. A kinetics for a reaction network  $\{\mathcal{S}, \mathcal{C}, \mathcal{R}\}$  is an assignment to each reaction  $y \rightarrow y' \in \mathcal{R}$  of a continuous rate function  $\mathcal{K}_{y \rightarrow y'}: \overline{\mathbb{P}}^{\mathcal{S}} \rightarrow \overline{\mathbb{P}}$  such that

$$\mathcal{K}_{y \rightarrow y'}(c) > 0 \text{ if and only if } \text{supp } y \subset \text{supp } c. \quad (2.1)$$

Interpretation: In the context of Lecture 1  $\mathcal{K}_{y \rightarrow y'}(c)$  was the occurrence rate of the reaction  $y \rightarrow y'$  when the (spatially homogeneous) contents of the reactor under study had composition  $c \in \overline{\mathbb{P}}^{\mathcal{S}}$ . There we required only that the rate functions take non-negative values. In condition (2.1) we go a little further by delineating those  $c \in \overline{\mathbb{P}}^{\mathcal{S}}$  for which the function  $\mathcal{K}_{y \rightarrow y'}(\cdot)$  takes positive values. Note that, for the reaction  $y \rightarrow y'$ ,  $\text{supp } y$  is just the set of species appearing in the reactant complex  $y$ . (Thus for  $A+C \rightarrow D$ ,  $\text{supp}(A+C) = \{A, C\}$ .) Roughly speaking,  $\text{supp } y$  is the set of "ingredients" required for the occurrence of  $y \rightarrow y'$ . On the other hand, if  $c \in \overline{\mathbb{P}}^{\mathcal{S}}$  is the instantaneous composition state of the mixture, then  $\text{supp } c$  is the set of species which are actually present in the reactor. (Recall Example 1.B.1.) In rough terms, then, (2.1) says this: Reaction  $y \rightarrow y'$  proceeds at non-zero rate (however slowly) if and only if the species appearing in the reactant complex  $y$  are actually present in the reactor. (For example,  $A+C \rightarrow D$  proceeds at non-zero rate if and only if  $c_A \neq 0$  and  $c_C \neq 0$ .)

Remark 2.4. Note that for strictly positive  $c$  — that is, for  $c \in \mathbb{P}^{\mathcal{S}}$  — we have  $\text{supp } y \subset \text{supp } c$  for all  $y \in \mathcal{C}$ . Thus, for  $c \in \mathbb{P}^{\mathcal{S}}$  we have

$$\kappa_{y \rightarrow y'}(c) > 0 \text{ for all } y \rightarrow y' \in \mathcal{R}, \quad (2.2)$$

which is to say that all reactions are "switched on".

In fact, we can describe somewhat more general circumstances under which (2.2) holds. By way of example consider the network



From (2.1) it follows that (2.2) will hold if and only if  $c \in \overline{\mathbb{P}}^{\mathcal{S}}$  is such that  $c_A$ ,  $c_B$  and  $c_C$  are positive, even when  $c_D = 0$ . The key idea here is that all reactions will be switched on if and only if all species appearing in reactant complexes are present in the reactor.

Let  $\{\mathcal{S}, \mathcal{C}, \mathcal{R}\}$  be a reaction network. We denote by  $\mathcal{C}_r$  the set of reactant complexes in the network:

$$\mathcal{C}_r := \{y \in \mathcal{C} : \text{There exists } y \rightarrow y' \in \mathcal{R}\}. \quad (2.4)$$

Moreover, we denote by  $\mathcal{S}_r$  the set of reactant species — that is, the set of those species that appear in reactant complexes:

$$\mathcal{S}_r := \bigcup_{y \in \mathcal{C}_r} \text{supp } y. \quad (2.5)$$

Then (2.2) will hold if and only if  $c \in \overline{\mathbb{P}}^{\mathcal{S}}$  is such that

$$\mathcal{S}_r \subset \text{supp } c. \quad (2.6)$$

Note that, for  $c \in \mathbb{P}^{\mathcal{S}}$ , (2.6) holds so that (2.2) holds as well.

Remark 2.5. I should say a few words about the role that condition (2.1) in Definition 2.2 will eventually play. We shall see in Section 2.C how the "only if" part of (2.1) guarantees that the differential equations we shall study have the natural property that, for each  $\delta \in \mathcal{S}$ ,  $\dot{c}_\delta \geq 0$  whenever  $c_\delta = 0$ . The "if" part of (2.1) will usually play a role through Remark 2.4, which characterizes the set of compositions at which all reactions proceed at non-zero rates. In such instances readers should be able to see how the "if" part of (2.1) can be dropped, provided that the set of compositions satisfying (2.6) is replaced by the set of compositions satisfying (2.2). To some extent condition (2.1) amounts to a convenience which precludes the necessity for a more "fussy" treatment.

I should perhaps also mention that there is a way of doing business somewhat different from the one we are employing here. Instead of positing a "reacts to" relation at the outset one can instead begin with rate functions and use them to define a "reacts to" relation at each  $c \in \overline{\mathbb{P}}^{\mathcal{S}}$ . In rough terms, one specifies  $\mathcal{S}$  and  $\mathcal{C}$ , and then one associates a real-valued rate function  $\mathcal{K}_{(y,y')}(\cdot)$  on  $\overline{\mathbb{P}}^{\mathcal{S}}$  with each element  $(y,y') \in \mathcal{C} \times \mathcal{C}$ . These functions need not satisfy a condition such as (2.1) and, in fact, some of them can be identically zero on  $\overline{\mathbb{P}}^{\mathcal{S}}$ . One then says that  $y$  reacts to  $y'$  at composition  $c \in \overline{\mathbb{P}}^{\mathcal{S}}$  if  $\mathcal{K}_{(y,y')}(c) \neq 0$ . Thus, the "reacts to" relation becomes a local notion on  $\overline{\mathbb{P}}^{\mathcal{S}}$ . This slightly different viewpoint, which has some advantages, is essentially that taken in some early work by Horn and me ([H3], [F2]).

Remark 2.6. Recall from Lecture 1 that  $\overline{\mathbb{P}}^I$  is the set of non-negative real-valued functions with domain  $I$ . Thus, each rate function is an element of  $\overline{\mathbb{P}}^{\overline{\mathbb{P}}^{\mathcal{S}}}$ . Since a kinetics is an assignment to each reaction  $y \rightarrow y' \in \mathcal{R}$  of a rate function  $\mathcal{K}_{y \rightarrow y'}(\cdot)$ , a kinetics is itself a function  $\mathcal{K}: \mathcal{R} \rightarrow \overline{\mathbb{P}}^{\overline{\mathbb{P}}^{\mathcal{S}}}$ . With this in mind I shall often refer to "a kinetics  $\mathcal{K}$ ".

Definition 2.3. A reaction system  $\{\mathcal{S}, \mathcal{C}, \mathcal{R}, \mathcal{K}\}$  is a reaction network  $\{\mathcal{S}, \mathcal{C}, \mathcal{R}\}$  endowed with a kinetics  $\mathcal{K}$ .

Next we consider the archetypical example, mass action kinetics.

Definition 2.4. A kinetics  $\mathcal{K}$  for a reaction network  $\{\mathcal{S}, \mathcal{G}, \mathcal{R}\}$  is mass action if, for each  $y \rightarrow y' \in \mathcal{R}$ , there exists a positive number  $k_{y \rightarrow y'}$  such that

$$\mathcal{K}_{y \rightarrow y'}(c) \equiv k_{y \rightarrow y'} \prod_{\delta \in \mathcal{S}} c_{\delta}^{y_{\delta}}. \quad (2.7)$$

The positive number  $k_{y \rightarrow y'}$  is called the rate constant for the reaction  $y \rightarrow y'$ .

Remark 2.7. Note that in (2.7)  $y_{\delta}$  is the stoichiometric coefficient (Remark 2.3) of species  $\delta$  in the reactant complex  $y$  of the reaction  $y \rightarrow y'$ . Thus, for reaction  $A+C \rightarrow D$  of network (1.1), equation (2.7) becomes

$$\begin{aligned} \mathcal{K}_{A+C \rightarrow D}(c) &\equiv k_{A+C \rightarrow D} (c_A)^1 (c_B)^0 (c_C)^1 (c_D)^0 (c_E)^0 \\ &= k_{A+C \rightarrow D} c_A c_C. \end{aligned}$$

Similarly,

$$\begin{aligned} \mathcal{K}_{2B \rightarrow A}(c) &\equiv k_{2B \rightarrow A} (c_A)^0 (c_B)^2 (c_C)^0 (c_D)^0 (c_E)^0 \\ &= k_{2B \rightarrow A} (c_B)^2 \end{aligned}$$

And so on.

Remark 2.8. Because we will be working extensively with mass action kinetics it will be useful to introduce the special notation used by Horn and Jackson [HJ]. For  $c$  and  $y$  in  $\overline{\mathbb{P}}^{\mathcal{S}}$  we define  $c^y$  as follows:

$$c^y := \prod_{\delta \in \mathcal{S}} c_{\delta}^{y_{\delta}}. \quad (2.8)$$

Thus, mass action rate functions take the form

$$\mathcal{K}_{y \rightarrow y'}(c) \equiv k_{y \rightarrow y'} c^y. \quad (2.9)$$

Remark 2.9. A mass action kinetics for a reaction network  $\{\mathcal{S}, \mathcal{C}, \mathcal{R}\}$  is completely specified by an assignment to each reaction  $y \rightarrow y' \in \mathcal{R}$  of a positive rate constant  $k_{y \rightarrow y'}$ . This is to say that a mass action kinetics is specified by an element  $k \in \mathbb{P}^{\mathcal{R}}$ . (Recall Example 1.B.2.) Thus, notwithstanding a minor abuse of language, we shall speak of a "mass action kinetics  $k$ " and of a "mass action system  $\{\mathcal{S}, \mathcal{C}, \mathcal{R}, k\}$ ." In this context it will be understood that  $k$  is an element of  $\mathbb{P}^{\mathcal{R}}$ .

### 2.C. The Differential Equations for a Reaction System

In Lecture 1 I indicated by means of an example how one writes the differential equations for a reaction system. Here I show how the differential equations for a general reaction system can be cast in vectorial terms. We begin with the following definition:

Definition 2.5. Let  $\{\mathcal{S}, \mathcal{C}, \mathcal{R}\}$  be a reaction network. The reaction vector corresponding to reaction  $y \rightarrow y' \in \mathcal{R}$  is the vector  $y' - y \in \mathbb{R}^{\mathcal{S}}$ .

Remark 2.10. Note that the component\* of  $y' - y$  corresponding to species  $\delta \in \mathcal{S}$  is just  $y'_{\delta} - y_{\delta}$ , the difference between the stoichiometric coefficient of  $\delta$  in the product complex  $y'$  and its stoichiometric coefficient in the reactant complex  $y$ . This difference is the net number of molecules of  $\delta$  produced with each occurrence of the reaction  $y \rightarrow y'$ . Consider, for example, the reaction  $A \rightarrow 2B$  in network (1.1); the corresponding reaction vector is  $2B - A$ . The "B<sup>th</sup> component" is 2, the "A<sup>th</sup> component" is -1, and the components corresponding to C, D and E are each zero.

---

\*The components to which we refer are, of course, the components of  $y' - y$  relative to the standard basis for  $\mathbb{R}^{\mathcal{S}}$ . Keeping in mind the "space of functions" interpretation of  $\mathbb{R}^{\mathcal{S}}$ , we might rephrase Remark 2.10 as follows:  $y' - y$  is that function in  $\mathbb{R}^{\mathcal{S}}$  that assigns to each  $\delta \in \mathcal{S}$  the net number of molecules of  $\delta$  produced with each occurrence of the reaction  $y \rightarrow y'$ .



Definition 2.6. For a reaction system  $\{S, C, R, K\}$  the species formation rate function  $f: \bar{\mathbb{P}}^S \rightarrow \mathbb{R}^S$  is defined by\*\*

$$f(c) \equiv \sum_{\mathcal{R}} \kappa_{y \rightarrow y'}(c)(y' - y) . \quad (2.10)$$

That is,  $f(\bullet)$  is obtained by summing the reaction vectors for the network, each multiplied by the corresponding reaction rate function.

Interpretation: If, in our homogeneous reactor, the instantaneous composition is  $c \in \bar{\mathbb{P}}^S$  then, for each  $s \in S$ ,  $f_s(c)$  gives the instantaneous rate of generation (per unit volume of mixture) of moles of species  $s$  due to the simultaneous occurrence of all reactions in  $\mathcal{R}$ . Note that

$$f_s(c) = \sum_{\mathcal{R}} \kappa_{y \rightarrow y'}(c)(y'_s - y_s) , \quad (2.11)$$

so that  $f_s(c)$  is obtained by summing all the reaction occurrence rates, each weighted by the net number of molecules of  $s$  produced with each occurrence of the corresponding reaction (Remark 2.10). This is essentially the idea we used in Lecture 1.

Before proceeding further we show that, for any reaction system, the species formation rate function inherently possesses a natural property: If, for some species  $s$ ,  $c \in \bar{\mathbb{P}}^S$  is such that  $c_s = 0$  then, at composition  $c$ , the rate of production of  $s$  cannot be negative.

---

\*\* The symbol  $\mathcal{R}$  below a summation sign will always be understood to be an abbreviation for " $y \rightarrow y' \in \mathcal{R}$ ".

Lemma 2.1. Let  $\{S, C, R, K\}$  be a reaction system with species formation rate function  $f(\cdot)$ . Then, for every  $\delta \in S$  and every  $c \in \bar{\mathbb{P}}^S$ ,  $c_\delta = 0$  implies that  $f_\delta(c) \geq 0$ .

Proof. Let  $\hat{c} \in \bar{\mathbb{P}}^S$  be such that, for some  $\delta^* \in S$ ,  $\hat{c}_{\delta^*} = 0$ . Note that  $\delta^* \notin \text{supp } \hat{c}$ . Recall from Definition 2.2 that  $K_{y \rightarrow y'}(c) = 0$  when  $\text{supp } y \not\subset \text{supp } c$ . Thus,  $K_{y \rightarrow y'}(\hat{c}) = 0$  for all  $y \rightarrow y' \in R$  such that  $y_{\delta^*} \neq 0$ . Therefore at composition  $\hat{c}$  the only reactions that might proceed at non-zero rates are those contained in the set

$$R^* := \{y \rightarrow y' \in R : y_{\delta^*} = 0\}. \quad (2.12)$$

Writing (2.7) for species  $\delta^*$  we obtain, for the composition  $\hat{c}$ ,

$$\begin{aligned} f_{\delta^*}(\hat{c}) &= \sum_{R} K_{y \rightarrow y'}(\hat{c}) (y'_{\delta^*} - y_{\delta^*}) \\ &= \sum_{R^*} K_{y \rightarrow y'}(\hat{c}) y'_{\delta^*}. \end{aligned} \quad (2.13)$$

Since  $y'_{\delta^*} \geq 0$  for all  $y \in C$  and since rate functions take non-negative values we have  $f_{\delta^*}(\hat{c}) \geq 0$ .  $\quad \text{///}$

Remark 2.11. From (2.13) it follows that  $f_{\delta^*}(\hat{c})$  will be positive if and only if there exists  $y \rightarrow y' \in R$  such that  $y'_{\delta^*} > 0$  and  $\text{supp } y \subset \text{supp } \hat{c}$ .

Remark 2.12. Note that in the proof of Lemma 2.1 the "if" part of condition (2.1) in Definition 2.2 plays no role. Lemma 2.1 is implicit in §1.6 of Fife's monograph [F5], where he discusses some of its consequences in the broader context of reaction-diffusion equations.\*

Remark 2.13. The species formation rate function for a mass action system  $\{\mathcal{S}, \mathcal{G}, \mathcal{R}, k\}$  takes the form

$$f(c) \equiv \sum_{\mathcal{R}} k_{y \rightarrow y'} c^y (y' - y), \quad (2.14)$$

where  $c^y$  is given by (2.8).

By the differential equation for a reaction system we mean

$$\dot{c} = f(c), \quad (2.15)$$

where the dot denotes time differentiation and  $f(\cdot)$  is the species formation rate function. That is, for a reaction system  $\{\mathcal{S}, \mathcal{G}, \mathcal{R}, \mathcal{K}\}$  the corresponding differential equation is

$$\dot{c} = \sum_{\mathcal{R}} \mathcal{K}_{y \rightarrow y'}(c) (y' - y). \quad (2.16)$$

---

\* For his purposes Fife requires more smoothness in the rate functions than we have imposed in Definition 2.2. For much of what we shall do here continuity is enough. In dealing with mass action kinetics we shall have smoothness on  $\mathbb{IP}^*$  by virtue of the functions involved. When some of the stoichiometric coefficients take values in the interval (0,1) we lose some differentiability of mass action rate functions on the boundary of  $\mathbb{IP}^*$ , but this will have only minor consequences in what follows.

This, of course, is a vector differential equation which encodes the system of scalar equations

$$\dot{c}_s = \sum_{\mathcal{R}} \mathcal{K}_{y \rightarrow y'}(c) (y'_s - y_s) , \quad \forall s \in \mathcal{S} . \quad (2.17)$$

For the network (1.1) in Lecture 1, the system (2.17) reduces to (1.4).

In particular, for a mass action system  $\{\mathcal{S}, \mathcal{G}, \mathcal{R}, k\}$  the corresponding (vector) differential equation is

$$\dot{c} = \sum_{\mathcal{R}} k_{y \rightarrow y'} c^y (y' - y) . \quad (2.18)$$

The individual species equations are

$$\dot{c}_s = \sum_{\mathcal{R}} k_{y \rightarrow y'} c^y (y'_s - y_s) , \quad \forall s \in \mathcal{S} . \quad (2.19)$$

For the mass action system depicted in (1.6) the system (2.19) reduces to (1.7).

## 2.D. An Elementary Connection between Reaction Network Structure and the Nature of Composition Trajectories

In this section I want to explore an elementary property of the differential equations induced by a reaction system. The essential idea here is that, regardless of the kinetics, reaction network structure alone imposes restrictions on the way that composition trajectories can look. In particular, a trajectory that passes through composition  $c \in \overline{\mathbb{P}}^{\mathcal{S}}$  can eventually reach composition  $c' \in \overline{\mathbb{P}}^{\mathcal{S}}$  only if the pair  $(c', c)$  is compatible with

certain "stoichiometrical" conditions the reaction network imposes. In very rough terms, composition trajectories are not generally free to wander in an arbitrary fashion through  $\overline{\mathbb{P}}^{\mathcal{S}}$  because there are only certain directions in which the species formation rate vector can point.

To see this we consider a reaction system  $\{\mathcal{S}, \mathcal{G}, \mathcal{R}, \mathcal{K}\}$ . The species formation rate function is given by

$$f(c) = \sum_{\mathcal{R}} \kappa_{y \rightarrow y'}(c)(y' - y) . \quad (2.20)$$

Thus, for each  $c \in \overline{\mathbb{P}}^{\mathcal{S}}$ ,  $f(c)$  is a non-negative linear combination of the reaction vectors for the network  $\{\mathcal{S}, \mathcal{G}, \mathcal{R}\}$ . In particular, for  $c \in \mathbb{P}^{\mathcal{S}}$   $f(c)$  is a positive linear combination of the reaction vectors. (The same is true for any  $c$  satisfying (2.6).) In any case  $f(c)$  must point along the cone generated by the reaction vectors and must certainly lie in the linear subspace of  $\mathbb{R}^{\mathcal{S}}$  spanned by them. This last idea serves as motivation for our next definition.

Definition 2.7. The stoichiometric subspace for a reaction network  $\{\mathcal{S}, \mathcal{G}, \mathcal{R}\}$  is the linear subspace  $S \subset \mathbb{R}^{\mathcal{S}}$  defined by

$$S := \text{span} \{y' - y \in \mathbb{R}^{\mathcal{S}} : y \rightarrow y' \in \mathcal{R}\} .$$

Remark 2.14. By the span of the set of reaction vectors we mean of course the linear subspace of  $\mathbb{R}^{\mathcal{S}}$  consisting of all real linear combinations of them. The discussion just prior to Definition 2.7 suggests that we should also have interest in the stoichiometric cone for a network, defined to be the set of all non-negative linear combinations of its reaction vectors. It is easy to see, however, that the stoichiometric cone and stoichiometric subspace for a network coincide when the zero vector in  $\mathbb{R}^{\mathcal{S}}$  is representable as a positive linear combination of the reaction vectors, and we shall see in Lecture 5 that this last condition must be satisfied if a reaction system is to admit an equilibrium in  $\mathbb{P}^{\mathcal{S}}$ . Since we shall focus heavily on situations in which there does exist a positive equilibrium, there will be no distinction between the stoichiometric cone and the stoichiometric subspace in much of what we do.

Since the species formation rate function for a reaction system must take values in the stoichiometric subspace for the underlying reaction network, we shall want to know something about the size of that subspace. With this in mind we record the following definition:

Definition 2.8. The rank of a reaction network is the rank of its set of reaction vectors. That is, the network  $\{S, G, R\}$  has rank  $s$  if there exists in the set

$$\{y' - y \in \mathbb{R}^S : y \rightarrow y' \in R\} \quad (2.21)$$

a linearly independent subset containing  $s$  vectors but no linear independent subset containing  $s+1$  vectors. We shall reserve the symbol  $s$  to denote the rank of a network.

Remark 2.15. From elementary considerations in linear algebra it follows that the dimension of the stoichiometric subspace for a reaction network is just the rank of the network:

$$s = \dim S \quad (2.22)$$

Example. For network (1.1) the reaction vectors are

$$\{2B-A, A-2B, D-A-C, A+C-D, B+E-D, A+C-B-E\} \quad (2.23)$$

The three-element subset

$$\{2B-A, A+C-D, B+E-D\} \quad (2.24)$$

is linearly independent, and any vector in (2.23) can be written as a linear combination of (2.24). Thus,  $s=3$  so that the stoichiometric subspace for network (1.1) is a three-dimensional linear subspace of the five-dimensional ambient vector space  $\mathbb{R}^S$ .

I have already indicated that limitations on the directions in which species formation rate vectors can point place restrictions on the way composition trajectories can evolve. The following lemma describes such a restriction.

Lemma 2.2. Let  $\{f, G, R, K\}$  be a reaction system, and let  $c: I \rightarrow \overline{\mathbb{P}}^s$  be a solution of

$$\dot{c} = \sum_{\mathcal{R}} \kappa_{y \rightarrow y'}(c)(y' - y) , \quad (2.25)$$

where  $I \subset \mathbb{R}$  is an interval. Then, for each  $t_1, t_2 \in I$  with  $t_2 > t_1$ , there exists an  $\alpha \in \overline{\mathbb{P}}^{\mathcal{R}}$  such that

$$c(t_2) - c(t_1) = \sum_{\mathcal{R}} \alpha_{y \rightarrow y'}(y' - y) . \quad (2.26)$$

Proof. Integrating (2.25) between  $t_1$  and  $t_2$  along the solution  $c(\cdot)$  we obtain

$$c(t_2) - c(t_1) = \sum_{\mathcal{R}} \left( \int_{t_1}^{t_2} \kappa_{y \rightarrow y'}(c(\tau)) d\tau \right) (y' - y) . \quad (2.27)$$

Noting that each integrand in (2.27) is non-negative, we set

$$\alpha_{y \rightarrow y'} = \int_{t_1}^{t_2} \kappa_{y \rightarrow y'}(c(\tau)) d\tau , \quad \forall y \rightarrow y' \in \mathcal{R} . \quad (2.28)$$

In this way we obtain (2.26) from (2.27). ///

Remark 2.16. Note that if, at some instant  $t^* \in [t_1, t_2]$  we have

$$\kappa_{y \rightarrow y'}(c(t^*)) > 0, \quad \forall y \rightarrow y' \in \mathcal{R},$$

then  $\alpha$  can be taken to be strictly positive. This follows easily from the construction given in (2.28) and the continuity of the functions  $\kappa_{y \rightarrow y'}(c(\cdot))$ . Similarly  $\alpha$  can be taken to be strictly positive if, for each reaction, there exists an instant in  $[t_1, t_2]$  at which that reaction is "switched on".

Lemma 2.2 tells us that a composition  $c' \in \overline{\mathbb{P}}^{\mathcal{S}}$  can follow a composition  $c \in \overline{\mathbb{P}}^{\mathcal{S}}$  along a solution of (2.25) only if  $c' - c$  lies in the stoichiometric subspace (and, in particular, the stoichiometric cone) for the network  $\{\mathcal{S}, \mathcal{C}, \mathcal{R}\}$ . Thus, if  $c: I \rightarrow \overline{\mathbb{P}}^{\mathcal{S}}$  is a solution of (2.25) which passes through a composition  $c^0$  then, for all  $t \in I$ , we must have

$$c(t) \in (c^0 + S) \cap \overline{\mathbb{P}}^{\mathcal{S}}, \quad (2.29)$$

where  $S$  is the stoichiometric subspace and

$$c^0 + S = \{c^0 + \gamma \in \mathbb{R}^{\mathcal{S}} : \gamma \in S\}. \quad (2.30)$$

This is to say that a composition  $c$  can lie on a trajectory passing through  $c^0$  only if  $c$  and  $c^0$  are "stoichiometrically compatible".



Definition 2.9. Let  $\{\mathcal{S}, \mathcal{C}, \mathcal{R}\}$  be a reaction network, and let  $S \subset \mathbb{R}^{\mathcal{S}}$  be its stoichiometric subspace. Two vectors  $c \in \overline{\mathbb{P}}^{\mathcal{S}}$  and  $c' \in \overline{\mathbb{P}}^{\mathcal{S}}$  are stoichiometrically compatible if  $c' - c$  lies in  $S$ . Stoichiometric compatibility is an equivalence relation that induces a partition of  $\overline{\mathbb{P}}^{\mathcal{S}}$  [resp.,  $\mathbb{P}^{\mathcal{S}}$ ] into equivalence classes called the stoichiometric compatibility classes [resp., positive stoichiometric compatibility classes] for the network. In particular, the stoichiometric compatibility class containing  $c \in \overline{\mathbb{P}}^{\mathcal{S}}$  is the set  $(c+S) \cap \overline{\mathbb{P}}^{\mathcal{S}}$ , and the positive stoichiometric compatibility class containing  $c \in \mathbb{P}^{\mathcal{S}}$  is the set  $(c+S) \cap \mathbb{P}^{\mathcal{S}}$ .

Our considerations thus far give some geometric insight into the way phase portraits are structured. A composition trajectory passing through composition  $c^0$  must lie entirely within the stoichiometric compatibility class containing  $c^0$ . In rough terms this stoichiometric compatibility class is obtained by shifting  $S$  up to  $c^0$  (by parallel translation) and intersecting the resulting parallel of  $S$  with  $\overline{\mathbb{P}}^{\mathcal{S}}$ . Some examples might be helpful.

Example 2.D.1. Consider the simple network

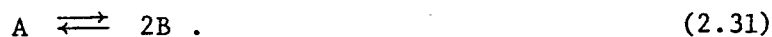

Here  $\mathcal{S} = \{A, B\}$ , and the reaction vectors are

$$\{A-2B, 2B-A\} \subset \mathbb{R}^{\mathcal{S}}.$$

The rank of the network is clearly one, and the stoichiometric subspace  $S$  is one-dimensional: it is the line in  $\mathbb{R}^{\mathcal{S}}$  containing the vector  $A-2B$ . The stoichiometric compatibility classes are those parts of lines parallel to  $S$  that lie in  $\overline{\mathbb{P}}^{\mathcal{S}}$ . Regardless of the kinetics, each composition trajectory compatible with the induced differential equations lies entirely within a stoichiometric compatibility class.

For illustrative purposes we shall suppose that network (2.31) is endowed with mass action kinetics. In this case the appropriate differential equations are

$$\dot{c}_A = k_{2B \rightarrow A} (c_B)^2 - k_{A \rightarrow 2B} c_A \quad (2.32)$$

$$\dot{c}_B = 2k_{A \rightarrow 2B} c_A - 2k_{2B \rightarrow A} (c_B)^2$$

The set of equilibrium points for (2.32) is given by those  $c \in \overline{IP}$  that satisfy

$$c_A = \frac{k_{2B \rightarrow A}}{k_{A \rightarrow 2B}} (c_B)^2 \quad (2.33)$$

The phase portrait for (2.32) is sketched in Figure 2.1.

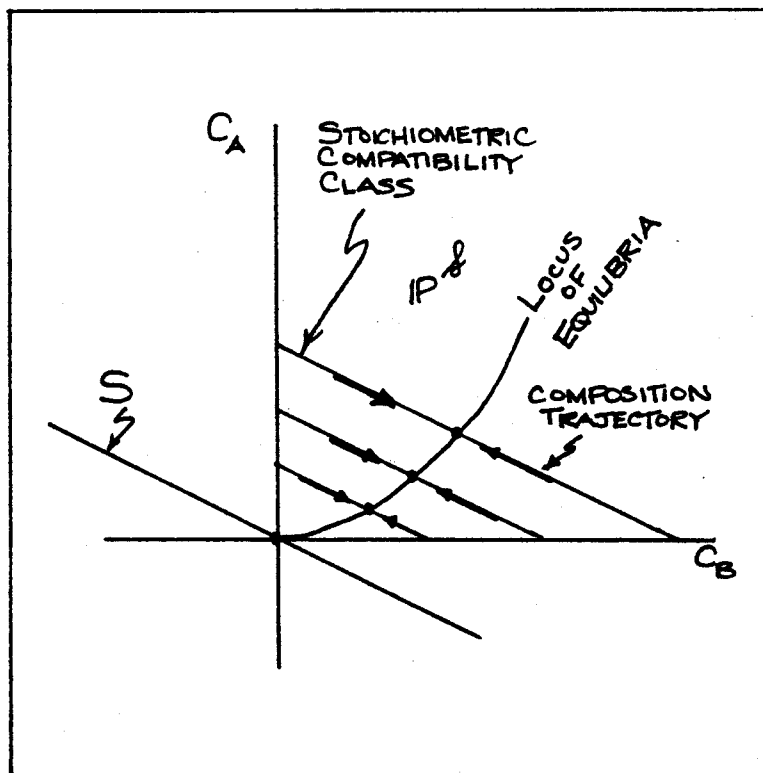
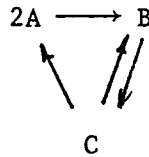

Figure 2.1

Example 2.D.2. Consider the network



(2.34)

Here  $\mathcal{R} = \{A, B, C\}$ , and the four reaction vectors are

$$\{B-2A, B-C, C-B, 2A-C\} \subset \mathbb{R}^{\mathcal{R}}.$$

The rank of the network is readily confirmed to be two so that the stoichiometric subspace  $S$  is two-dimensional. The stoichiometric compatibility classes, as indicated in Figure 2.2, are those triangles which are the intersection of parallels of  $S$  with  $\bar{\mathbb{P}}^{\mathcal{R}}$ . As the figure is intended to suggest, a composition trajectory must lie entirely within a stoichiometric compatibility class.

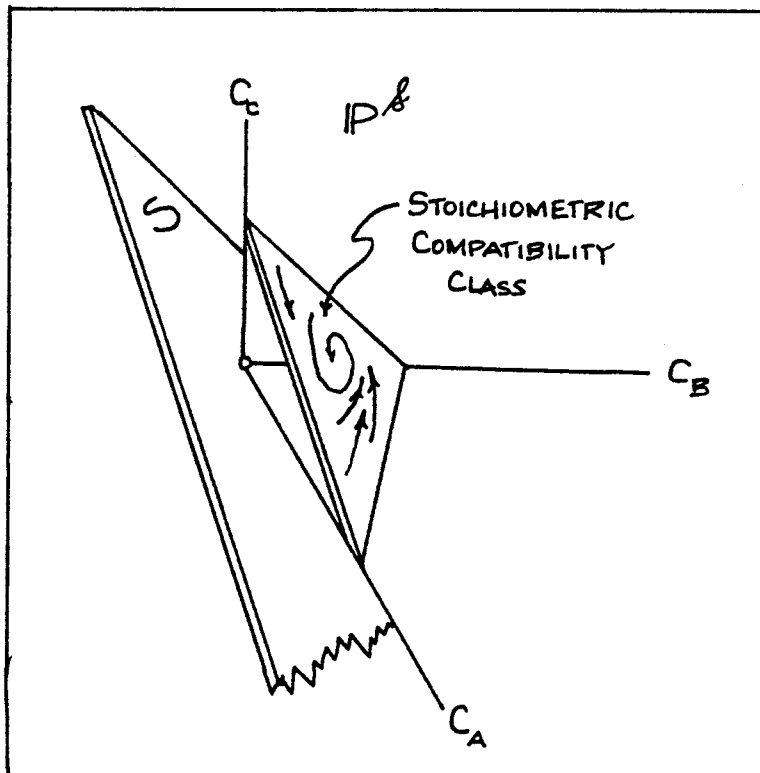
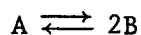

Figure 2.2

Remark 2.17. We introduced the notion of stoichiometric compatibility in anticipation of certain questions we shall raise in the next lecture. In particular, we shall be interested in the existence of multiple positive equilibria. To ask, without qualification, whether the differential equations for a reaction system admit more than one positive equilibrium is to ask a question too broadly posed, for even the very simple system discussed in Example 2.D admits a wealth of positive equilibria. The question of real interest is whether the differential equations for a reaction system can admit multiple positive equilibria within a stoichiometric compatibility class — that is, whether there can exist two or more positive equilibria which are stoichiometrically compatible with the same initial composition. (For the mass action system discussed in Example 2.D.1 the answer is no.) Similarly, when we speak of stability of an equilibrium we shall always mean stability relative to initial conditions within the stoichiometric compatibility class containing that equilibrium.

### 2.E. Open Systems: Why Study "Funny" Reaction Networks?

In this section I want to explain why, in subsequent lectures, we shall admit for consideration networks containing peculiar reactions like  $A \rightarrow 2A$  or  $0 \rightarrow A$  (zero reacts to A) which, at first glance, appear to be incompatible with the conservation of matter. In fact, we shall want to consider networks such as



(2.35)

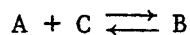

which offend our sensibilities in a more subtle way: If a molecule of A can decompose into two molecules of B, then the molecular weight of a molecule of B would appear to be half that of a molecule of A. How then can a molecule of B result from a chemical combination of the heavier molecule of A with a molecule of C?

In order to understand why it makes sense to consider such peculiar networks, we must move beyond the simple picture painted at the beginning of Lecture 1 — a picture that has motivated all our considerations thus far. There we studied a homogeneous reactor (portrayed in Figure 1.1) which was closed with respect to the exchange of matter with the external world. Composition changes resulted solely from the occurrence of chemical reactions, and our differential equations were formulated accordingly.

We would also like to study homogeneous (well-stirred) reactors that are open to the influx or efflux of at least certain species. In this case we would expect composition changes to result not only from the occurrence of chemical reactions but also from the transport of various species into and out of the reactor. Consequently, these effects should also manifest themselves in the differential equations that govern the reactor's behavior. For this reason the differential equations (2.16) and (2.18) we have begun to examine might seem inappropriate to the study of open reactors, for those equations were developed in consideration of reactors in which composition changes come about by virtue of chemical reactions alone.

The fact is, however, that equations (2.16) and (2.18) are indeed suited to the study of important categories of open reactors, provided that our conception of a reaction network is suitably broadened to incorporate certain "pseudo-reactions" tailored to encode the infusion or effusion of those species supplied to or removed from a particular open reactor under study. That is, there are varieties of open reactors for which the appropriate differential equations can be viewed as deriving from a reaction network obtained by modifying or augmenting the true chemical network in such a way as to model, by means of "pseudo-reactions", various non-chemical effects.

We shall see how this works in a few examples, but before turning to them I want to make explicit the importance of our ability to subsume open reactors within the framework we have erected so far. Suppose that the possibilities suggested in Lecture 1 could be realized, that there could be developed a theory of the general mass action equation (2.18) which would, for example, indicate that the differential equations for networks of a certain large class cannot admit periodic orbits for any set of rate constants. Suppose further that a particular open system could be modelled

in terms of a reaction network (composed in part of "pseudo-reactions") taken with mass action kinetics. That is, suppose (2.18), written for the model network and its kinetics, would yield precisely those differential equations one would write for the open system from first principles. Then the aforementioned theory of equation (2.18) would connect qualitative properties of these equations with the structure of the model network, and the possibility of periodic orbits for the open system under study might, for example, be decided solely on the basis of model network structure. In this way the theory would provide information not only about closed reactors but about open reactors as well.

We turn now to three examples in which we indicate how, by means of appropriately constructed model networks, certain categories of reactors are in fact describable within the framework we have already constructed. So that the basic ideas should not be obscured I have, in each case, taken the "true" chemistry to be very simple. The examples are easily generalized to situations in which the chemistry is far more complex. Moreover, in each example I have taken the kinetics of the true reactions to be mass action, and I have indicated how each reactor is describable in the context of the mass action equation (2.18). When the kinetics is not mass action, similar considerations enable one to describe each reactor in the context of the more general equation (2.16).

Example 2.E.1 (Continuous Flow Stirred Tank Reactors). Consider the reactor shown in Figure 2.3. The reactor contents, a liquid mixture of species A and B, are maintained homogeneous, isothermal, and of fixed volume (which, for the purposes of this example, we shall take to be unity). Feed of fixed composition is continuously supplied to the reactor at a constant volumetric flow rate  $g$  (volume/time) with molar concentrations of A and B in the feed equal to  $c_A^f$  and  $c_B^f$ , respectively. The contents of the reactor are continuously removed at volumetric flow rate  $g$ . In the reactor the only chemical reactions which occur are



The kinetics is mass action with rate constants as indicated in (2.36). Species balances for A and B yield the following pair of differential equations for  $c_A$  and  $c_B$ , the molar concentrations of A and B within the reactor:

$$\begin{aligned} \dot{c}_A &= g c_A^f - g c_A + 2k' c_B - 2k c_A^2 \\ \dot{c}_B &= g c_B^f - g c_B = k c_A^2 - k' c_B \end{aligned} \quad (2.37)$$

Written for the mass action system (2.36), equation (2.18) does not reduce to (2.37); terms corresponding to the feed and effluent are absent.

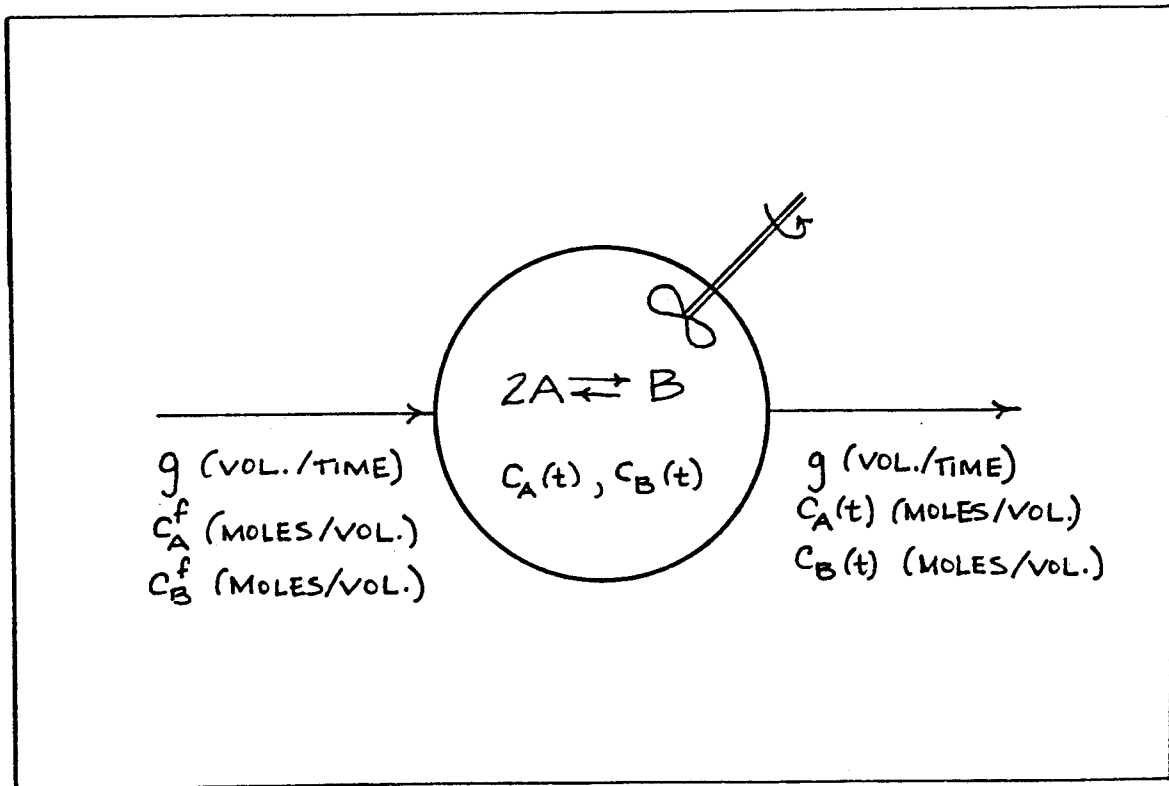

Figure 2.3

Consider, however, the model network (2.38):



The entity "0" in (2.38) is the zero complex, interpreted as the zero vector of  $\mathbb{R}^{\mathcal{S}}$  (where, for our example,  $\mathcal{S} = \{A, B\}$ ). The reactions  $0 \rightarrow A$  and  $0 \rightarrow B$  are adjoined to the reactions  $2A \rightleftharpoons B$  to reflect the infusion of A and B in the feed, and the reactions  $A \rightarrow 0$  and  $B \rightarrow 0$  are similarly adjoined to reflect the effusion of A and B in the exit stream. Now suppose that this model network is assigned mass action kinetics with rate constants as indicated alongside the reaction arrows in (2.38). Then (2.18), written for the mass action system depicted in (2.38), yields a vector differential equation whose component equations are precisely those displayed in (2.37).\*

Thus, any results obtained for equation (2.18) which draw connections between dynamics and reaction network structure become applicable to the flow reactor we have been considering, provided it is understood that the network of interest is (2.38) rather than the simpler (2.36).

It is not difficult to see how wide varieties of continuous flow stirred tank reactors can be codified in reaction network terms by the means described here.

Example 2.E.2. (Homogeneous Reactors with Certain Species Concentrations Regarded Constant)

We shall consider a reactor studied by Edelstein [E]. The reactor contents are well-stirred and are maintained at constant temperature and volume. The reactions occurring are those depicted in the network (2.39):

---

\* Note that, according to the mass action prescription (2.7), the reaction  $0 \rightarrow A$  with rate constant  $g c_A^f$  proceeds at rate  $(g c_A^f)(c_A)^0(c_B)^0 = g c_A^f$ .



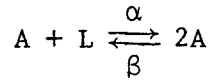

(2.39)

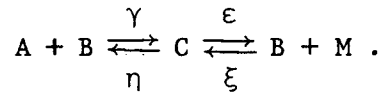

The kinetics is mass action with rate constants denoted by Greek letters alongside the corresponding reaction arrows. We shall suppose that species L and M are added to or removed from the reactor in such a manner as to keep the molar concentrations of L and M within the reactor fixed at values  $c_L^*$  and  $c_M^*$ , respectively. The differential equations for the five species concentrations within the reactor are then

$$\dot{c}_A = \alpha c_L^* c_A - \beta c_A^2 - \gamma c_A c_B + \eta c_C$$

$$\dot{c}_B = -\gamma c_A c_B + \eta c_C + \epsilon c_C - \xi c_M^* c_B \quad (2.40)$$

$$\dot{c}_C = \gamma c_A c_B - \eta c_C - \epsilon c_C + \xi c_M^* c_B$$

$$\dot{c}_L = 0$$

$$\dot{c}_M = 0 .$$

These are not the differential equations one would obtain by writing (2.18) for the mass action system depicted in (2.39).

However, the first three equations of (2.40) — the only ones of real interest — are induced by the mass action system

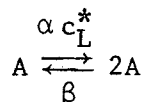

(2.41)

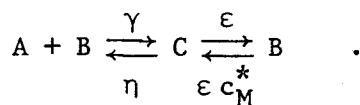

That is, the evolution of the molar concentrations of species A, B and C are described by the first three equations of (2.40), and these can be viewed as deriving from the model network (2.41) by means of the usual mass action formalism. Thus, any theory of equation (2.18) that draws connections between dynamics and network structure becomes applicable to the Edelstein system, so long as it is understood that the network of interest is that shown in (2.41) rather than that shown in (2.39).

This example is easily generalized to other reactors of similar type. To obtain the appropriate model network, one merely "strips away" species with time-invariant concentration from the network of true chemical reactions,\* and one modifies certain rate constants in a manner suggested by the example.

---

\* If all species in a particular complex have time-invariant concentrations, then the "stripping away" procedure will result in the zero complex.

Remark 2.18. The reactor considered in Example 2.E.2 is open: species L and M are added to and removed from the reactor in such a way as to maintain the concentrations of L and M within the reactor constant in time. In fact, the example — at least in the way I described it — is somewhat farfetched, for it is difficult to see how, in practical terms, control of the concentrations of L and M could be easily managed.

Nevertheless, Example 2.E.2 amounts to a formalization of a common situation that chemists really do think about. Imagine that Edelstein's reactions (2.39) are taking place in a closed reactor in which species L and M are present in amounts much larger than those of A, B and C. In such a situation it is reasonable to suppose that, for a very long time, the concentrations of L and M can be deemed constant in the differential equations for A, B and C; there simply isn't enough A, B or C available to make a dent in the amounts of L and M — at least not in the short run. In the context of this supposition and for a reasonably chosen time interval, the closed Edelstein reactor is, insofar as the dynamics of A, B and C are concerned, more or less equivalent to the physical picture I painted in Example 2.E.2; and the differential equations for A, B and C can be viewed as having been induced by the model mass action system depicted in (2.41).

Example 2.E.3. (Interconnected Cells) As shown in Figure 2.4 each of two cells contains a mixture of species A and B. The mixture in each cell is maintained homogeneous, and we shall presume that the mixture volumes are each maintained at unity and that the temperatures in the two cells are maintained at the same constant value. Species A and B diffuse from cell to cell at rates proportional to the difference in species concentration between the cells. That is, the net rate of receipt of moles of A in cell 1 is  $D_A(C_{A_2} - C_{A_1})$ , where  $D_A$  is a "diffusion constant" for species A,  $C_{A_1}$  is the molar concentration of A in cell 1, and  $C_{A_2}$  is the molar concentration of A in cell 2. Similarly, the net rate of receipt of moles of B in cell 1 is  $D_B(C_{B_2} - C_{B_1})$ . We presume also that the reactions



occur within each cell and that the kinetics is mass action with rate constants  $k$  and  $k'$  as indicated.

The differential equations that govern the system are

$$\begin{aligned} \dot{C}_{A_1} &= -kC_{A_1} + k'C_{B_1}^2 + D_A(C_{A_2} - C_{A_1}) \\ \dot{C}_{B_1} &= 2kC_{A_1} - 2k'C_{B_1}^2 + D_B(C_{B_2} - C_{B_1}) \\ \dot{C}_{A_2} &= -kC_{A_2} + k'C_{B_2}^2 + D_A(C_{A_1} - C_{A_2}) \\ \dot{C}_{B_2} &= 2kC_{A_2} - 2k'C_{B_2}^2 + D_B(C_{B_1} - C_{B_2}) . \end{aligned} \quad (2.43)$$

These certainly are not the differential equations induced by the mass action system (2.42), but they are the differential equations induced by the model network

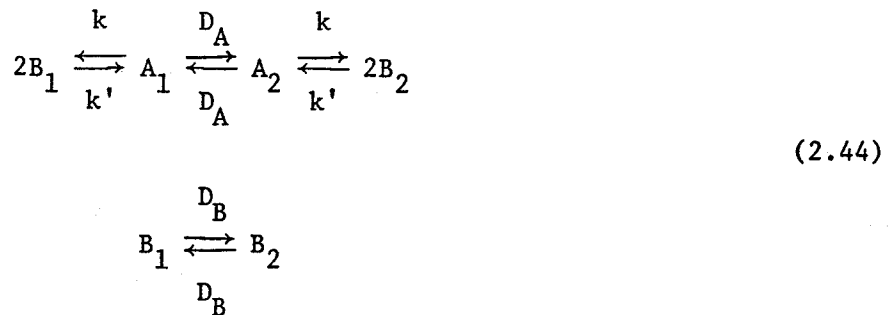

taken with mass action kinetics with rate constants as indicated. Thus, any theory of equation (2.18) that draws connections between dynamics and reaction network structure becomes applicable to the system considered here, provided it is understood that the network of interest is that displayed in (2.44).

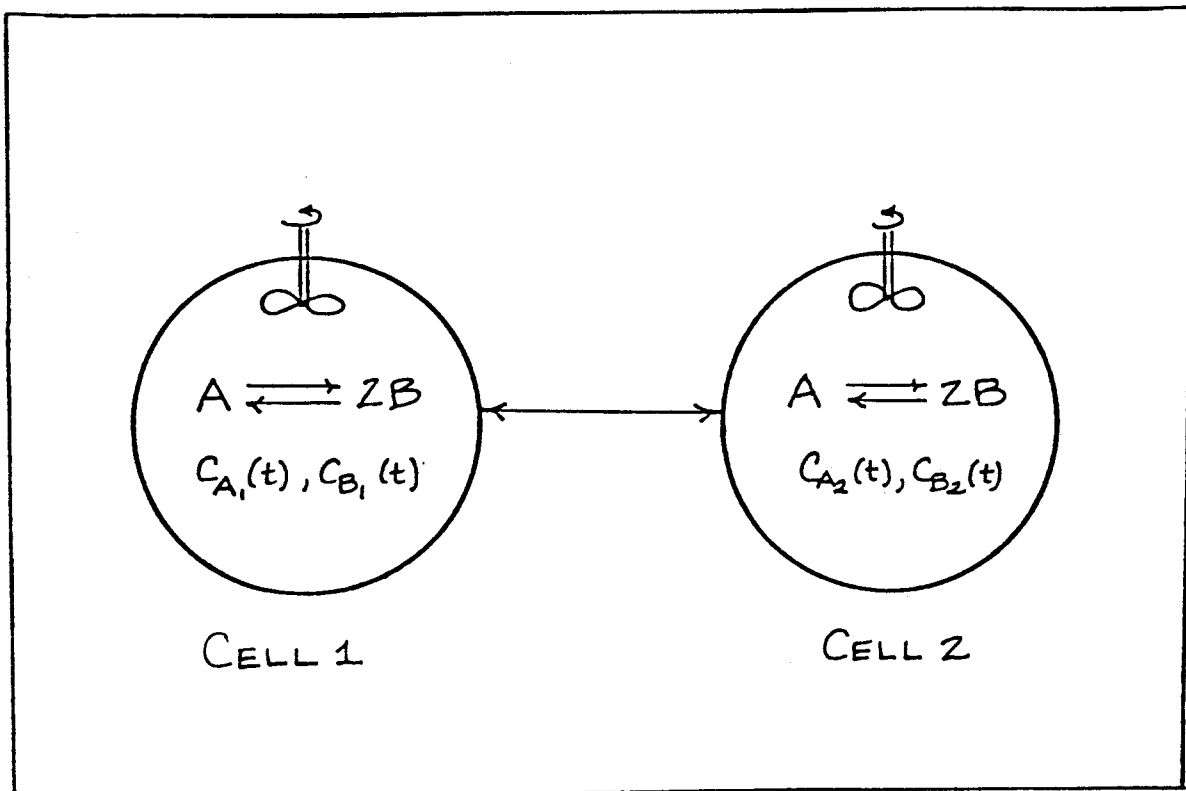
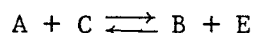
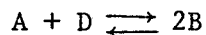

Figure 2.4

It is not difficult to see that one can let the number of cells get large and still effect a model network description in the same way. The chemistry within the cells can, of course, be considerably more complicated than we have indicated in this example. Indeed, the cells may be of the kind in Example 2.E.2 in which certain species concentrations are deemed time-invariant.

Interconnected cells have been studied from a reaction network viewpoint by Shapiro and Horn in [SH] and [S]. I will discuss their work briefly in Lecture 9, but I would strongly encourage readers interested in interconnected cells to see [SH] for a fuller summary of some striking results.

Examples 2.E.1-2.E.3 provide only a partial picture of the way in which the framework we have constructed is sufficiently broad as to accommodate a large variety of reactors by means of suitably constructed model networks. These few examples should nevertheless make clear why we would like whatever theory we generate to embrace networks which contain "funny" reactions such as  $A \rightarrow 2A$  or  $0 \rightarrow A$  and which apparently violate conservation of matter. Indeed, the seemingly strange network (2.35) with which we began our discussion might have result<sup>ed</sup> from the "stripping away" (in the sense of Example 2.E.2) of species D and E from the network



Thus, network (2.35) becomes a legitimate object of study in the context of a reactor in which the concentrations of D and E are regarded fixed.

Motivated by these considerations we shall in fact take the view that all reaction networks are legitimate objects of study. In this way we can aspire to a theory that embraces all networks we are likely to encounter, be they "true" chemical networks or model networks that describe reactors like those considered in our examples.

Remark 2.19. Although we shall consider all reaction networks as suitable objects of study, I should point out that those networks which are compatible with mass conservation have certain pleasant properties.

Following Horn and Jackson [HJ], I say that a network  $\{S, C, R\}$  is conservative if there exists a (positive) vector  $M \in \mathbb{R}^S$  contained in  $S^\perp$ , the orthogonal complement of the stoichiometric subspace for the network. This condition can be given a rough interpretation in the following way: Think of  $M$  as a vector of molecular weights,  $M_\lambda$  being the molecular weight

of species  $\delta$ . If, in a constant volume homogeneous reactor,  $c_\delta$  is the instantaneous molar concentration of species  $\delta$  (which, it will be recalled, is proportional to the number of molecules of  $\delta$  per unit volume), then  $M_\delta c_\delta$  gives the instantaneous mass (per unit volume) of  $\delta$  in the reactor. Thus, if  $c \in \overline{\mathbb{P}}^{\mathcal{S}}$  is the instantaneous reactor composition then

$$M \cdot c = \sum_{\delta \in \mathcal{S}} M_\delta c_\delta$$

gives the instantaneous total mass (per unit reactor volume) of all species appearing in the network.

Now if  $\mathcal{K}$  is a kinetics for the network and  $f(\cdot)$  is the species formation rate function for the reaction system  $\{\mathcal{S}, \mathcal{G}, \mathcal{R}, \mathcal{K}\}$ , we have, for any  $c \in \overline{\mathbb{P}}^{\mathcal{S}}$ ,

$$M \cdot \dot{c} = M \cdot f(c) = 0. \quad (2.45)$$

The second equation in (2.45) holds because  $M$  lies in  $S^\perp$  while  $f(\cdot)$  takes values in  $S$ . Interpreting  $M$  as we have, we can regard (2.45) as ensuring that the total mass of the reactor contents is time-invariant.

One of the pleasant features of conservative networks is given by Horn and Jackson. They show that a network is conservative if and only if all its stoichiometric compatibility classes are compact. (What we call stoichiometric compatibility classes are called reaction simplices in [HJ].) Because our interest will not be limited to conservative networks, we shall not in general have compactness of the stoichiometric compatibility classes.