

AN ABSTRACT OF THE THESIS OF

Kerry P. Browne for the Degree of Doctor of Philosophy in Physics presented on August 1, 2001. Title: A Case Study of How Upper-Division Physics Students Use Visualization While Solving Electrostatics Problems.

Abstract Approved: _____
Corinne A. Manogue

Presented here is a case study of the problem-solving behaviors of upper-division undergraduate physics majors. This study explores the role of visual representations in students' problem solving and provides a foundation for investigating how students' use of visualization changes in the upper-division physics major. Three independent studies were conducted on similar samples of students. At the time of these studies, all of the subjects were junior physics majors participating in the Paradigms in Physics curriculum at Oregon State University. In the first study, we found that while the students all scored very high on the Purdue Spatial Visualization Test, the correlation between test scores and their grades in physics was not statistically significant. In the second study (N=5) and the third study (N=15), we conducted think-aloud interviews in which students solved electrostatics problems. Based on the interviews in the third study, we develop a model that describes the process by which students construct knowledge while solving the interview problems. We then use this model as a framework to propose hypotheses about students' problem solving behavior. In addition, we identify several difficulties students have with the concepts of electric field and flux. In particular, we describe student difficulties that arise from confusing the vector and field line representations of electric field. Finally, we describe some student difficulties we observed and suggest teaching strategies that may assuage them.

© Copyright by Kerry P. Browne
August 1, 2001
All Rights Reserved

A Case Study of How Upper-Division Physics Students
Use Visualization While Solving Electrostatics Problems

by
Kerry P. Browne

A THESIS

Submitted to

Oregon State University,

In partial fulfillment of
the requirements for the
degree of

Doctor of Philosophy

Presented August 1, 2001
Commencement June 2002

Doctor of Philosophy thesis of Kerry P. Browne presented on August 1, 2001

APPROVED:

Major Professor, representing Physics

Chair of the Department of Physics

Dean of the Graduate School

I understand that my thesis will become part of the permanent collection of Oregon State University libraries. My signature below authorizes the release of my thesis to any reader upon request.

Kerry P. Browne, Author

ACKNOWLEDGEMENTS

I would like to thank my advisor Corinne A. Manogue for her guidance and support throughout my graduate career. Her teaching experience and knowledge of student behavior have been indispensable in the formulation and completion of this project. Working with her in class and watching her as a teacher has taught me the importance of listening in teaching. Our interactions over these past few years have been some of the most rewarding and enriching experiences of my life. As I look to the future it makes me happy to envisage our continued collaboration and friendship. My hope is that one day I will be as good a teacher to my students as she has been to me.

I would also like to thank my father and mother for their perpetual inspiration throughout my career as a student. Throughout my life, they have encouraged me to follow my dreams and have always been there to support me as I pursued them.

I extend my thanks and appreciation to Allen Wasserman, David McIntyre, Janet Tate and all the professors who have taught in the Paradigms in Physics Program. The experience I gained teaching and developing curriculum with each of you has been an invaluable asset throughout this project.

I would also like to acknowledge Norm Lederman, Larry Enochs and Maggie Niess of the OSU Science and Mathematics Education Department for their direction as I planned and carried out this project. Without the benefit of their expertise, this project would not have been possible.

Thanks to Emily Townsend for her unceasing optimism and friendship. Our timely conversations have buoyed me throughout this process. Thanks to Ross Brody for being a willing and good humored guinea pig. Also, thanks to Heidi Clark for her support and encouragement over the last several years. Special thanks to Rachel Sanders and the crew at the 21st Street Home for Wayward Boys for keeping me fed and sane over the past few weeks as I finished writing and prepared

for my defense. I would also like to thank all my friends in the OSU Mountain Club for helping me maintain my sanity by sharing the outdoors with me.

My sincerest appreciation goes to Priscilla Laws and David Jackson for their encouragement and support as I finished the final rewrites on this thesis.

Last but not least, my gratitude to the students who participated in this project for their time and patience. Without their generous gift of time this project would have been impossible.

Financial support for this project has been provided by the National Science Foundation and Oregon State University.

TABLE OF CONTENTS

	<u>Page</u>
CHAPTER 1 INTRODUCTION	1
1.1 Introduction to the Literature	1
1.2 PER in the Upper-Division vs. PER in the Lower-Division	2
1.3 Statement of the Problem and Significance of the Study	4
1.4 Thesis Outline	6
CHAPTER 2 REVIEW OF THE LITERATURE.....	9
2.1 Student Difficulties in Electrostatics.....	10
2.2 Spatial Ability and Science Performance.....	11
2.3 Visualization and Problem Solving.....	11
2.4 Modeling the Use of Visualization in Problem Solving	14
2.5 Expert and Novice Problem Solving.....	15
CHAPTER 3 DESCRIPTION OF THE SUBJECTS.....	17
3.1 Background of the Subjects	17
3.2 The Paradigms in Physics Program	17
3.3 The Junior Year Transition	21
3.3.1 Piaget’s Model of Cognitive Development	22
3.3.2 The Vygotskian Approach to Cognitive Psychology	24
3.3.3 Implications of the theories of Piaget and Vygotsky’s for the Junior Year Transition	26
CHAPTER 4 MEASUREMENT OF STUDENTS’ SPATIAL ABILITIES.....	30
4.1 Sample.....	32
4.2 Choice of Measurement Instrument (PSVT)	32
4.3 Data Collection Procedures.....	34
4.4 Data Analysis	35
4.5 Results.....	38
4.5.1 Correlation between Spatial Ability and GPA	38
4.5.2 Multiple Regression Analysis for Predicting Course Grades.....	39
4.6 Conclusions.....	43

CHAPTER 5 RESEARCH DESIGN	45
5.1 Think-Aloud Interviews.....	46
5.2 Interview and Transcript Procedures	49
CHAPTER 6 PRELIMINARY INTERVIEWS	50
6.1 Sample.....	50
6.2 Data Collection and Interview Protocol.....	51
6.3 The Interview Problem.....	53
6.4 Results/Analysis.....	54
6.4.1 Definitions	55
6.4.2 Visual and Symbolic Steps.....	56
6.4.3 Visual Problem Solving Strategies.....	61
6.4.4 Visual Reconstruction.....	61
6.4.5 Visual Simplification.....	65
6.4.6 Summary of Analysis	69
CHAPTER 7 FINAL INTERVIEWS	71
7.1 Sample.....	71
7.2 Data Collection and Interview Protocol.....	72
7.3 Choice of the Interview Problem	76
7.4 Results/Analysis.....	77
7.4.1 Overall Performance.....	78
7.4.2 A Model of Construction and Checking.....	81
7.4.2.1 Complex Structures.....	86
7.4.2.2 Difficult or Trivial?.....	90
7.4.2.3 Moving on with the Aid of Terminating Statements	93
7.4.3 Student Understanding of Flux.....	96
7.4.3.1 Students' Explanations of Electric Flux.....	97
7.4.3.2 Gauss's Law and Field Lines.....	101
7.4.3.3 Incomplete and Incorrect Models of Flux.....	104
CHAPTER 8 DISCUSSION	108
8.1 The Role of Visualization in Problem Solving	108
8.2 Construction in Problem Solving.....	111
8.3 Students' Models of Electric Flux.....	114
8.4 What to do About Field Lines.....	115
8.5 The Transition from Novice to Professional.....	117
8.6 Closing	119

REFERENCES.....	122
APPENDIX PROBLEM SOLUTIONS.....	126
The Problem.....	126
Solution 1	126
Solution 2	130

LIST OF FIGURES

	<u>Page</u>
Figure 4.1 - Plot of the linear fit obtained from the PSVT vs. incoming math and physics GPA regression analysis.	39
Figure 4.2 - A plot of measured data and the fit values from a multiple linear regression. The plot shows the projection of this four dimensional data set onto the Incoming Math and Physics GPA and PH424 course grade axes.	42
Figure 4.3 – A plot of measured data and the fit values from a multiple linear regression. The plot shows the projection of this four dimensional data set onto the PSVT score and PH323 course grade axes.	42
Figure 7.1 - Interview timeline and problem statement.	73
Figure 7.2 - Diagrammatic representation of the conclusions/check model.	83
Figure 7.3 - Diagrammatic representation of Enkidu's conclusion and checking process.	84
Figure 7.4 - Diagrammatic representation of Q's construction of the flux equation.	87
Figure 7.5 - Diagrammatic representation of Parsec's construction of the flux equation.	89
Figure 7.6 - Diagrammatic representation of Turtle's conclusion to use cylindrical coordinates.	91
Figure 7.7 - Diagrammatic representation of Q's construction of da	92
Figure 7.8 - Pictorial representation of connections between the verbal, symbolic and visual representations of flux.	97
Figure 8.1 - Three representations of electric flux.	111
Figure 8.2 - Field line diagrams commonly used in the introduction of the integral formulation of Gauss's Law.	116

LIST OF TABLES

	<u>Page</u>
Table 3.1 - Schedule of Paradigms courses indicating interviews and administration of the PSVT	20
Table 4.1 - Average grades in each of the Paradigms courses (0-4).....	38
Table 4.2 - Tabulation of statistics from a multiple regression predicting course grades with a linear model including spatial ability (PSVT score), incoming math and physics GPA and sex.	40
Table 4.3 – Tabulation of the squares of the semipartial correlation coefficients (sr_i^2) and their p values for a linear model including spatial ability (PSVT score), incoming math and physics GPA and sex as predictors for class grades.....	40
Table 6.1 - Tabulation of subjects GPA, grade in the Static Vector Fields course (PH 322) and score on the Purdue Spatial Visualization Test.	51
Table 6.2 - Tabulation of coding scheme.....	61
Table 7.1 - Tabulation of students' PSVT scores and Incoming Math and Physics GPA.....	72
Table 7.2 - Grouping of Subjects by Performance.....	79
Table 7.3 - Grouping of subjects by solution characteristics.	80
Table 7.4 - Characterization of students' explanation and use of flux	100

A Case Study of How Upper-Division Physics Students use Visualization While Solving Electrostatic Problems

Chapter 1 Introduction

Einstein indicated that his thought processes were dominated by images and that “logical construction in words or other kinds of signs” was a secondary thought process. (Einstein in a letter to Jacques Hadamard). In describing his diagrammatic approach to field theory, Richard Feynman emphasized the importance of abstract visualization. In an interview with James Gleick (1992), he explained, “What I am really trying to do is bring birth to clarity, which is really a half-assedly thought-out-pictorial semi-vision thing. ... It's all visual. It's hard to explain.” Statements like these suggest that visual thinking is an important and possibly essential ingredient in mathematical and scientific creativity.

1.1 Introduction to the Literature

While more emphasis is generally placed on the role of symbolic-analytic thinking, in science and mathematics education, the importance of visualization in problem solving has been recognized in the mathematics education literature. There has been significant research on the role of visual methods in mathematical problem solving (See for example: Lean and Clements, 1981; Presmeg, 1986, 1992; Webb, 1979; Zazkis, Dubinsky and Dautermann, 1996). In particular, research by Webb (1979) and Lean and Clements (1981) suggests that visual strategies are particularly useful in solving complex and non-routine problems. Presmeg (1986, 1992) examined high school students’ use of visual problem solving methods in solving mathematics problems. Her interviews with 54

“visualizers” identified visual methods used by these students as well as important advantages and difficulties that these students experienced with visual problem-solving methods. Zazkis, Dubinsky and Dautermann (1996) introduce a provocative model that describes the interplay of visual and analytic thinking in problem solving. Considering the mathematical nature of problem solving in physics, this research is relevant to the current study.

While visual problem solving has received somewhat less attention in the Physics Education Research (PER) community, the literature contains several studies examining how expert and novice problem solvers approach problems at the lower-division level. (See for example: Larkin & Reif, 1979; Larkin, 1981; Larkin, McDermott, Simon & Simon 1980; Van Heuvelen, 1991). These studies have examined and modeled how students solve problems in physics primarily in the realm of introductory mechanics. Some of this research explores how students use fundamental physical principles to solve problems (Larkin, 1981) while others explore a broader collection of problem-solving phenomena including qualitative and visual problem solving methods (Van Heuvelen, 1991). Both the physics and mathematics education literature provide an important foundation for the present study. Each will be discussed in more detail in Chapter 2.

1.2 PER in the Upper-Division vs. PER in the Lower-Division

Educational research and curriculum development in upper-division physics are still in their infancy. While considerable effort has been put into physics education research at the high school and lower-division level, very little research has been done on learning in upper-division physics (McDermott & Redish, 1999). Very recently, some work has been done in an effort to test and improve students understanding in upper-division quantum mechanics (Cataloglu & Robinett, 2001; Redish, Steinberg & Wittmann, 2000). These efforts are still in their early stages and standard instruments like the Force Concepts Inventory (FCI) (Hestenes, Wells

& Swackhammer, 1992) and Mechanics Baseline Test (Hestenes & Wells, 1992) have not yet been developed for use in the upper-division.

The educational research that has addressed upper-division problems very closely resembles physics education research at the lower division. Many of these studies are based on the assumption that the important questions at the lower-division translate to the upper division. While it is possible that this assumption is reasonable, it is currently unsupported by research. Currently, no studies have been undertaken to determine which research questions are of most importance in the upper-division.

Clearly, our goals and expectations for lower-division students are significantly different from our goals and expectations for physics majors. In particular, the content presented at the upper-division has a different emphasis and requires more mathematical sophistication. We want our physics majors to learn the fundamentals well enough to extend their knowledge, but we also want them to have enough knowledge to be prepared for graduate school or the work force. In the upper division, we emphasize professional development activities much more than in introductory courses. Specifically, we put more emphasis on professional communication and laboratory skills. Finally, we expect our upper-division students to think with a higher level of abstraction and to be able to solve longer more complex problems. All of these differences suggest that the questions of interest to educational researchers studying upper-division physics will be significantly different from the interesting questions at the lower-division level.

In addition to these differences, the changes that physics students undergo in the upper-division are likely different from those experiences by students taking a single physics course. Much happens in the junior and senior year as students transition from novice to professional physicists. While our understanding of this transition is quite limited, it is certainly vastly different from the experience of the typical student in introductory calculus.

One of the major goals of this study is to begin to explore the issues of interest in the upper-division. Expressly, we intend to develop several hypotheses

and identify research questions that will be of particular interest to teachers and researchers working with upper-division physics students.

1.3 Statement of the Problem and Significance of the Study

It is widely acknowledged in the physics community that visual problem solving strategies are essential skills for students. However, the teaching of these strategies has often been given short shrift because instructors assume that students already know and use the requisite visual problem solving strategies. These same instructors are often baffled when their students do not use simple diagrams to solve exam problems. Alan Van Heuvelen (1991) reports that while essentially all physics teachers use diagrams in their problem solutions, only about 20% of the students in introductory calculus based physics use diagrams to help them solve problems on their final exams. When these students enter the upper-division, they are not well prepared to use visual methods to help them solve problems.

The Paradigms in Physics program (Manogue, et. al., 2000) has developed a new curriculum for the upper-division informed by research done at the lower-division. However, for programs like Paradigms in Physics to continue productive curriculum development, much more needs to be learned about how physics majors think and learn in their junior and senior years. A significant obstacle exists in the continued development of curriculum at the upper-division level. In order to continue to improve the upper-division curriculum, we need to enhance our understanding of the differences between upper-division and lower-division students. During development of the Paradigms in Physics curriculum (Manogue, et. al., 2001), it was noticed that most physics students undergo a dramatic change in how they think about physics between the beginning of the junior year and the end of the senior year. We expect that students' general level of sophistication increases rapidly as they make the transition from beginning physics students to

professional physicists. Still, we have little specific knowledge of the nature of this transition. Examining one piece of this transition is the focus of the current study.

In training physics majors, our goal is to help them become self-sufficient professionals. A non-trivial component of this preparation entails helping them begin the transition from novice to expert problem solvers. Considering the gap between the way students and experts use visual/qualitative methods in lower division physics (Van Heuvelen, 1991), a significant part of this transition must entail the development of visual problem solving skills. At the same time, the transition from lower-division to upper-division entails a substantial increase in the difficulty and complexity of problems students must solve. Thus, what we have learned about problem solving at the lower division may not be applicable to problem solving in the upper-division.

As described in above, research and curriculum development for upper-division physics is currently underway. These efforts are based primarily on lower-division physics education research. While this research is a good basis, significant differences exist between upper and lower-division students. Problem solving in general and particularly the use of visual problem solving methods are important aspects of student development at the upper-division level. The goal of this study is to develop a better understanding of how upper-division physics students use visualization in problem solving. Eventually, we would like to extend this research to study the changes that occur in students' problem solving behaviors as they transition into professional physicists.

In Chapters 6 and 7 of this study, physics students were interviewed while solving electrostatics problems. The interview transcripts were then analyzed in an effort to characterize the subjects' use of visual problem solving methods. The intent of this study was to closely examine the subjects' use of visual problem-solving methods in a complex problem typical of upper-division physics courses. These interviews were performed at the beginning of the junior year in an effort to explore how students solve problems as they enter the upper-division transition.

Often visualization research in physics involves the development of new visualization tools (Van Heuvelen & Zou, 1999; Jolly, Zollman, Rebello & Dimitrova, 1998) or the examination of student difficulties with standard visual representations (Törnkvist, Pettersson & Tranströmer, 1993). In contrast, the intent of this study is to explore how students use diagrams and pictures during independent problem solving. It is often assumed that students use visualization in the same ways that instructors do or that they use the visualizations we teach them in class. However, there is little evidence that suggests this is actually the case. The purpose of this study is to explore students' problem solving with a particular emphasis on the role of visual images.

This research will help inform curricular development efforts in upper-division physics. In particular, the results of this study can be used to inform teachers of the problem solving methods their students do and do not use. Teachers can then develop materials that utilize prevalent strengths or specifically address common deficiencies in students' problem solving. This study will also serve as a basis for further research into how the problem solving habits of physics students' change over the course of their junior and senior years.

1.4 Thesis Outline

In Chapter 2 we provide a brief review the relevant literature. Since we were unable to find any literature studying either the use of visualization or problem solving in upper-division physics, the literature reviewed here was drawn from several disciplines including: physics education, science education, math education and cognitive psychology. We describe studies that examine the importance of visual/qualitative thinking in physics and in particular electrostatics. We provide some background on the connection between science and spatial ability. We also review several papers exploring connections between visualization and problem solving. We examine in detail a model for exploring the interaction of visual and

analytic steps in the problem solving process. Finally we review some of the literature on expert and novice problem solving in physics.

In Chapter 3 we give a description of the subjects participating in this study. We characterize their backgrounds and give a brief description of the Paradigms in Physics curriculum they were engaged in during these interviews.

Chapter 4 contains a description of a study we performed in order to gauge the relationship between students spatial ability and their course grades in physics. We give a brief description of the sample. Next, we describe the Purdue Spatial Visualization Test (PSVT) and provide some evidence in support of our decision to use this instrument to measure students' spatial ability. We then describe our analysis procedures and present the results of our correlation analysis.

In Chapter 5 we explain our research, design, describe and justify the data collection methods we used for the studies presented in Chapters 6 and 7. We describe the think-aloud interview method and delineate our reasons for choosing this method of data collection. We also describe some of the methods we used to limit bias and ensure complete recording of the interview data.

Chapter 6 describes a pilot study in which seven students were interviewed while they solved an electrostatics problem. We outline the characteristics of the sample of student who participated in the study. We present a description of the interview protocol used in the data collection and give a description of the problem students were asked to solve during the interviews. The results of these interviews are presented in Section 6.4. We introduce and apply a new model for exploring the interaction between visual and symbolic processing in students problem solving. We also identify two visual problem-solving strategies that were observed in these interviews.

Chapter 7 describes a second set of interviews performed in the fall of 2000. These interviews were intended to extend the results of the study described in Chapter 6. We characterize the sample of 15 students interviewed and give a description of the protocol and problem used in this set of interviews. Section 7.4 contains a description of the results of this final set of interviews. Students' general

performance on the main problem is presented. A model of students' method for construction information is presented and used to describe some interesting problem solving behaviors. We also present observations of students' models of flux derived from problem solutions and students' responses to a direct question about flux.

Chapter 8 contains a discussion of the important results and hypotheses generated in these studies. Section 8.6 contains a summary of the most important hypotheses as well as recommendations for teachers. Suggestions for further work inspired by these results and hypotheses are also found in Chapter 8.

Chapter 2 Review of the Literature

A search of the physics and science education research literature revealed very few studies examining upper-division physics (Cataloglu & Robinett, 2001; Singh, 2001; Redish, Steinberg & Wittmann, 2000; Manogue, et. al., 2001). The Redish, Steinberg & Wittmann study and the Manogue, et. al., study are primarily focused on upper-division curriculum development. Cataloglu & Robinett describe the development and preliminary testing of an instrument to measure quantum mechanics performance in students as they progress through their undergraduate careers. Singh investigated physics majors' difficulties with quantum mechanics and specifically quantum measurement. No studies were found which explicitly addressed student use of visual problem solving methods in upper-division physics.

Several studies were found that explored student difficulties in electrostatics at the lower division level. In addition, we identified several studies that suggest spatial ability and performance in science and mathematics are linked. An article was also reviewed that indicated a connection between spatial ability and practical problem solving (Adeyemo, 1994). Also relevant for this study was a collection of articles exploring the relationship between visualization and problem solving in mathematics. Due to the mathematical nature of physics at the upper division, these studies were particularly relevant. Finally, we found several studies exploring the differences between expert and novice problem solvers in introductory physics. Since our population lies somewhere between experts and novices, these studies provide valuable information about the states between which our students are transitioning. This chapter contains a summary of the relevant literature identified in our literature search.

2.1 Student Difficulties in Electrostatics

Two studies illustrate the tendency of students at the lower division level to avoid qualitative methods when solving electrostatics problems. These studies highlight the lack of qualitative reasoning in many students' problem-solving repertoire. McMillan and Swadener (1991) indicated that few of the students participating in their study were able to reason qualitatively about the electrostatics problems they were presented. Greca & Moreira (1997) found that very few of their students developed mental models for working with concepts in electromagnetism. While this conclusion was based on a largely unexplained instrument, the model score, the authors indicated that subjects were probed for qualitative/visual understanding. A third study reviewed (Törnkvist, Pettersson, & Tranströmer, 1993) indicates some student difficulties in electrostatics can be attributed to students' application of field lines. The authors indicate that students "attach too much reality" to field lines resulting in confusion about the nature of the electric field.

In electromagnetism, qualitative understanding is often associated with a visual understanding of the interaction of vector and scalar fields. The finding that students lack qualitative understanding in electromagnetism may indicate that they do not use visual strategies to understand electromagnetic systems. In addition, the Törnkvist, et al. (1993) study suggests that students' ability to effectively use field lines, a qualitative representation, is inhibited because they have failed to clearly define the field line concept. Taking into account that professional physicists routinely use visual images when addressing electrostatics problems, these results demonstrate one important distinction between novice and expert problem solvers in physics.

2.2 Spatial Ability and Science Performance

While little research has been done on visualization in upper-division physics, the importance of visual thinking in mathematics and science is reflected in the literature. Much research has focused on improving our understanding of the role of visual thinking in math and science at the high school and lower-division levels. Several studies have explored the relationship between spatial ability and achievement in mathematics, science and engineering courses (Siemankowski & MacKnight, 1971; Burnett & Lane, 1980). In addition, Burnett, Lane and Dratt (1979) found that the well-documented dependence of mathematical ability on gender could be explained by differences in spatial ability.

It has been shown that spatial training can result in improvement in advanced mathematics (Mundy, 1987) performance. Small and Morton (1983) found that task specific spatial visualization training significantly enhanced student performance in organic chemistry. Pribyl and Bodner (1985) also found a strong correlation between spatial ability and performance in chemistry. Burnett & Lane (1980) found that spatial ability was significantly enhanced in students after two years of training in the physical sciences. These studies strongly suggest that the learning in science and mathematics is linked to visual thinking.

2.3 Visualization and Problem Solving

A number of studies have explored the role of visualization in problem solving. Researchers have examined the relationship between spatial ability and problem solving performance (Adeyemo, 1994; Lean & Clements, 1981). In both of these studies, only a small correlation between spatial ability and performance on practical problem solving tasks was measured. Adeyemo (1994) found that the practical problem solving performance of subjects exposed to visualization training increased significantly. Hortin, Ohlsen & Newhouse (1985) obtained similar

results. Unfortunately, these results were marred by unvalidated instrumentation. In contrast, Antonietti (1999) found that students' ability to use visualization in problem solving is severely limited by their ability to predict which problems will yield to visual strategies.

Lean and Clements suggest that a higher correlation might be measured if more complex, less familiar problems were used to measure mathematical problem solving ability. Antonietti (1999) examined subjects' ability to predict when visual strategies would be useful. This study revealed that subjects most

Lean and Clements (1981) explored the extent to which subjects' spatial ability and choice of problem solving method (visual or non-visual) were good predictors of performance on mathematical problems. The results of this study suggested that those subjects who chose to use visual problem solving methods performed at a lower level on mathematical problem solving tasks. Lean and Clements qualified this finding by indicating that the problems used to measure mathematical performance were straightforward and routine.

In contrast to Lean and Clements (1981) study, Webb (1979) found that students who preferred to use visual solution methods outperformed those who preferred non-visual. The primary difference between these studies was in the nature of the problems used. In comparison with Webb's study, the problem solving tasks used by Lean and Clements were simpler and more routine. These results suggest that visual problem solving methods are advantageous for complex and non-routine problems.

In contrast to the studies described above, Norma C. Presmeg has engaged in studies that explore the particular behavior of high school students as they use visualization in solving mathematics problems. She explored the kinds of visual imagery students used while solving mathematical problems in her 1986 qualitative study (Presmeg, 1986). The intent of this study was to "identify the strengths and limitations of visual imagery in high school mathematics." The author conducted problem-solving interviews with 54 high school students who preferred to use visual methods when solving mathematics problems. Presmeg described several

common difficulties students encountered during these interviews as well as some of the advantages these students' derived from using visual methods. This study was primarily descriptive, outlining the visual methods students used and the sources of difficulty they had with visual problem solving methods. She noted that one of the most important reasons students had difficulty using visualization while solving mathematics problems was because they did not use rigorous reasoning when working with visual representations.

In another paper (Presmeg, 1992), she emphasized the value of imagery as a method of abstraction in problem solving. She noted that many student difficulties with visualization as a problem-solving tool stemmed from the over-concretization of images. She notes that one of the primary values of visual problem solving is that it allows the solver to ignore unimportant details and utilize the flexibility afforded by visual models. However, she warns that students often take this flexibility too far forgetting to keep track of the limitations of the visual representation. Thus it appears that, when using visual representations, students walk a fine line between over-concretizing their images and forgetting the limitations of these representations.

In both of the studies reviewed here, Presmeg (1986; 1992) emphasizes abstraction and flexibility as the essential properties of visual representations that make them so useful in problem solving. Many of the visual models we use in physics are complete abstractions (field lines, field vectors, free body diagrams, Feynman diagrams, etc...) Even the concept of a graph of any sort is an abstraction. The lines of the graph do not correspond to lines in the physical world. Instead, these lines are a convenient way of representing the value of a physically measurable quantity. Although the quantities we discuss are real, the visual representations are abstract. With this in mind it is important to ask the question what are our goals for students in using visualization. Certainly, we want our physics majors to learn to use, connect and adapt existing visual representations that are common throughout physics. However, is it realistic to expect these students to be able to develop their own original visual representations? Much of

Presmeg's studies have focused on student's ability to spontaneously generate their own abstract visual representations. She has found that only a small fraction, one to 2 percent, of the high school mathematics students she studied regularly generated and used this type of abstract imagery. Based on this result, it may be more productive to study the ways that students recall, reconstruct and use visual representations they have been exposed to in class.

2.4 Modeling the Use of Visualization in Problem Solving

Zazkis, Dubinsky and Dautermann (1996) propose a novel model, the V/A model, to describe student problem solving in mathematics. According to this model, problem solving consists of an alternating sequence of visual and analytic steps. Each step involves some modification or manipulation of elements or entities from the previous steps, e.g., manipulation of an image to explore possible rotations of a square. Initially, the visual and analytic steps are quite distinct, but as the sequence progresses, the visual and analytic steps become more intertwined eventually leading to a solution.

The strength of this model is that it describes a variety of problem-solving behaviors involving at least some explicitly visual steps. The authors use the model to explain several scenarios in which subjects use various visual methods to solve the problem proposed. In cases where visualization was explicit, the authors identified several obvious analytical steps that were not apparent at first glance. However, the authors did not use the V/A model to examine solutions that involved primarily non-visual methods.

The V/A model was based on data from student interviews in which subjects were asked to explain their solutions to a mathematics problem. Data from these interviews was used to illustrate how the V/A model can be used to explain complex problem solving behavior. The authors acknowledge that their data is not extensive enough to test the correctness of this model, but conjecture that this or a

similar model might describe a large class of problem solving behaviors heretofore unexplained.

The behavior of individuals who primarily use visual problem solving strategies has been explored in some detail (Presmeg, 1986, 1992; Lean & Clements 1981; Moses, 1980). However, the literature (Presmeg, 1986) suggests that most students use some combination of visual and non-visual methods to solve problems. The V/A model is an attempt to describe the problem solving methods of these students. In addition, the V/A model is a first attempt at exploring the complex interplay of visual and non-visual steps in problem solving.

2.5 Expert and Novice Problem Solving

The study of expertise and the differences between expert and novice problem solvers is a mature field. A significant amount of this research has focused on development of expertise in learning introductory mechanics. Introductory mechanics has been the focus of expertise research primarily because it is a real system that is quantitative enough to be modeled easily with computer simulations. Jill Larkin compared students' behavior to such a computer model in a 1981 study. This study revealed that novice students' mechanics problem-solving behaviors could be modeled reasonably well with a simple computer simulation. In particular she found that the students and the simulation tended to work backwards from the desired quantities toward the given quantities. Interestingly, by giving the computer simulation some rudimentary learning capabilities its problem solving behaviors changed significantly. Notably, the computer simulation began to solve problems starting with the given quantities and working toward the unknowns.

In 1980, Larkin, McDermott, Simon and Simon (1980) published a study describing the characteristics they observed in expert and novice subjects as they solved introductory mechanics problems. They found that in addition to solving simple mechanics problems faster than novices, the experts also solved problems in

the opposite order. That is, novice subjects, tended to “work backwards from the unknowns problem solution,” whereas experts worked from forward from the given elements of the problem to the solution. It was also noted in this study that the novice subjects verbalized many more of the steps in their problem-solving process than did the experts. The authors suggest that the experts had automated many of the common problem solving tasks through years of practice. Finally the authors note that the most significant difference between expert and novice problem solvers is the obvious, namely that the experts have far more knowledge. However, they preface this by noting that the expert’s knowledge is not just a huge collection of facts. Instead they suggest that an important characteristic of expert knowledge is the fact that such a large body of information is organized in a manner that facilitates rapid recall.

Chi, Glaser and Rees (1982) published a detailed review of the nature of problem solving expertise. Much of this review focuses on problem solving expertise in the realm of elementary mechanics. They outline some of the important characteristics of expert problem solving. Specifically, they note that expert’s tend to begin problems with a qualitative analysis. They describe several studies, which suggest that a significant component of this qualitative analysis involves the translation of the problem into a “physical representation.” That is to say, experts tend to recast the problem statement into a form containing well-defined scientific quantities. Once in this representation, the experts are able to solve the problem quickly.

These studies describe several important differences between novice and expert problem solvers. Notably,

1. Experts solve problems more quickly than novices do.
2. Experts tend to solve simple problems starting with givens and working toward the unknowns whereas novices tend to work in the opposite order.
3. Novices tend to verbalize more steps in their solution process than experts do.

Chapter 3 Description of the Subjects

The subjects in this study were physics or engineering-physics majors in their junior year of study at Oregon State University. They all participated in the Paradigms in Physics program, a recently developed curriculum for upper-division physics. The relevant details of this program are outlined in Section 3.2.

3.1 Background of the Subjects

While the physics majors studied are primarily white male, they enter the Paradigms in Physics program from diverse academic backgrounds. Roughly half of the students entering the junior year have transferred from a community college or another 4-year institution. In addition, approximately 10 percent of the students have studied abroad for at least one term.

Upon entering the junior year, all of the subjects have completed at least one year of introductory calculus-based physics. Most of them have taken a one-term modern physics course; however, some take this course during the first term of their junior year. In addition, all of the students have taken a standard calculus sequence through vector calculus.

3.2 The Paradigms in Physics Program

Because the students participated in an experimental physics curriculum, it is pertinent to include a brief description of the program since it differs significantly from the traditional junior-year physics curriculum. Details of the Paradigms in Physics Program were reported by Manogue, Siemens, Tate, Browne, Niess & Wolfer (2001). Students in the Paradigms program participate in nine short intensive courses over the course of their junior year. Each of these courses is built around a paradigmatic example in physics.

At the time of this study, the Paradigms courses included:

- *Symmetries and Idealizations* - A tutorial in the use of symmetries and idealizations to simplify physical systems and aid in problem solving. In this course, subjects studied topics that would prepare them to solve the problem posed in this study. Several particularly relevant topics were taught in this course. These included curvilinear coordinates, the definition of electric flux and the integral forms of Gauss's and Ampere's laws. In addition, students spent some time learning to visualize fields and field concepts. This course was instituted in the fall of 2000 to address pace and intensity issues brought to light by student comments, test performance and interview data acquired during the preliminary interviews described here.
- *Static Vector Fields* - An introduction to the manipulation of vector fields using examples from electrostatics, magnetostatics and gravity. Students explore the behavior of three dimensional vector fields with the aid of computer visualization tools and group activities. In the fall of 1999, this course introduced curvilinear coordinates, the definition of electric flux and the integral forms of Gauss's and Ampere's laws. In the fall of 2000 this material was transferred to the Symmetries and Idealizations course. This allowed more thorough coverage of these concepts and the introduction of more advanced topics in electricity and magnetism.
- *Oscillations* - A treatment of oscillations in time, including an introduction to Fourier series and transforms. This class is based around two integrated labs studying the oscillation of a compound pendulum and an RLC circuit.
- *Energy and Entropy* - An introduction to the connection between the macroscopic and microscopic worlds. This class explores the connection between quantum statistical mechanics and macroscopic measurements with the use of computer simulations.
- *One Dimensional Waves* - Explores the behavior of classical and quantum waves oscillating in one spatial dimension as well as in time. Students examine waves along a coaxial cable in an integrated lab.

- *Quantum Measurement and Spin* - Students examine the postulates of quantum mechanics. As an example, they use a computer simulation of the Stern-Gerlach experiment to explore the simplest of all quantum systems, the spin $\frac{1}{2}$ system.
- *Central Potentials* - Students learn about classical and quantum particles in three-dimensional central potentials. Computer visualization tools are used extensively as an aid to understanding three dimensional quantum fields.
- *Periodic Systems* - Students learn about quantum and classical periodic systems. Computer simulations are used to examine the behavior of a classical chain and the properties of a simple quantum lattice.
- *Rigid Bodies* - An introduction to the behavior of extended bodies. Students compare measurements and calculations of the inertial tensor for an extended body as part of an integrated lab.
- *Reference Frames* - An introduction to the concept of reference frames, Galilean transformations and Lorentz transformations. Students use computer visualization and simulation tools to examine how the choice of reference frame affects the observed properties of a body.

Each of these classes lasts three weeks and meets seven hours a week. A typical week consists of three hours of lecture and four hours of lab, group activities, computer visualization or other non-lecture activities. Table 3.1 shows the Paradigms schedule with the times at which interviews were conducted and the Purdue Spatial Visualization Test (PSVT) was administered.

Most students also attended two terms of an electronics lecture/lab course as well as a term-long course in classical mechanics during their junior year. In the senior year, students attended a collection of term long courses in more traditional physics subjects (quantum mechanics, math methods, electrodynamics, statistical physics, computational physics etc...). The intensive nature of the junior year courses, the inclusion of non-lecture teaching strategies and an overall reorganization of the junior year material are the most significant differences between Paradigms in Physics and the traditional physics curriculum. While the material covered in the Paradigms is very similar to that covered

by the traditional curriculum, the distribution of material between the junior and senior years is quite different.

	1999-2000 (Preliminary Interviews)		2000-2001 (Main Interviews)	
	Course	Measurement	Course	Measurement
Fall	Static Fields		Symmetries & Idealizations	PSVT
	Oscillations		Static Fields	
Winter	Waves		Waves	
	Quantum Measurement		Quantum Measurement	
Spring	Periodic Systems		Energy & Entropy	
	Rigid Bodies		Periodic Systems	
	Reference Frames		Rigid Bodies	
		PSVT		

Table 3.1 - Schedule of Paradigms courses indicating interviews and administration of the PSVT

At the time of this study, the Paradigms in Physics curriculum was still under development and was being evaluated. Thus, the students included in this study have been involved in other studies to measure the effectiveness of the paradigms. In particular, some of the subjects will have agreed to participate in verbal and e-mail

interviews about the Paradigms program. The unusual nature of the Paradigms in Physics curriculum places some restrictions on the generalizability of this study.

3.3 The Junior Year Transition

All of the subjects involved in the following studies were in the junior (3rd) year of their undergraduate physics major. Over the course of this year, students undergo considerable changes in the way they think and learn about physics. Corrine Manogue and her colleagues identified this period of rapid change as the junior year “brick wall”. (Manogue, Siemens, Tate, Browne, Niess & Wolfer, 2001). Throughout this document, we will refer to it as the junior year transition.

The beginning of the junior year marks the official transition between the lower division and the upper division. For most students, the first term of the junior year signifies the start of the journey toward a professional career in physics. But this transition has more than formal significance. Many things change for our students as they enter the junior year. As the number of physics courses in their schedules increases, so does the time commitment associated with each course. Their coursework becomes more difficult and requires a higher level of mathematical sophistication. In general, our expectations of students sharply increase as they enter the junior year of the physics.

In addition to these external changes, students learn to think about physics in a variety of new ways. In the junior year of the physics major, students are confronted with the formal, mathematical nature of the subject. They are expected to build their knowledge of physics on a framework of sophisticated formal concepts (i.e. fields, conservation principles, eigenvalues, etc...). In many ways, they rebuild and extend their understanding of physics on an entirely new vocabulary of formal concepts. By the time they complete their major, they are expected to be able to work and communicate effectively in this new language of physics. The cognitive changes that students undergo during the final two years of their physics major clearly amount to more than mere acquisition of new facts. In a very real sense, they are forced to develop fundamentally new ways of learning and understanding.

Researchers in the field of developmental psychology have studied how people learn to learn for nearly a century. Even though the bulk of this research has focused on cognitive development in children and adolescents, the framework developed by these researchers provides a valuable background for understanding how adults learn new ways of thinking. The works of two researchers in particular, Jean Piaget and L. S. Vygotsky, will be important for constructing a framework upon which to understand the junior year transition. In the next two subsections we will give a brief description of the relevant theoretical contributions of each.

3.3.1 Piaget's Model of Cognitive Development

Piaget recognized that children progress through certain well defined stages as they progress from infancy to adulthood. He identified four important stages of cognitive development: sensory motor, preoperational, concrete operational and formal operational. One of Piaget's most important discoveries is that children always go through these stages sequentially. He deduced from this that the thinking processes developed in each stage are prerequisites for development of thinking processes in later stages. Thus, subjects never exhibited the characteristics of formal operational reasoning without first exhibiting the characteristics of concrete operational reasoning.

The sensory-motor stage spans from infancy to about two years of age. The next stage is the preoperational stage in which children begin to piece together their experiences to obtain a basic understanding of their world. Most children undergo the transition from preoperational to concrete operational around the age of 7 or 8. Thus it is highly unlikely that any of the students in this study are in the preoperational stage. However, one important distinction should be made. Upon the transition to the concrete operational stage, children begin to internalize their actions. Piaget states that a subject in the preoperational stage, "acts only with a view toward achieving the goal; he does not ask himself why he succeeds." (Inhelder & Piaget, 1958) In contrast, a subject in the concrete operational stage is aware of the elements and operations involved in his task. Still, a subject in the concrete operational stage is limited. To a concrete operational

thinker, the elements and operations are fundamentally linked to the external world. That is, the elements in his "model" are concrete and physical.

For example, a young child learning to throw a ball may become quite proficient, but will not recognize the factors that lead to his success. On the other hand, a child in the concrete operational stage will recognize that the position of his arm when the ball is released and the strength with which he throws the ball contribute to determining where the ball will go. Notice that the subject is aware of only the concrete physical factors that affect his throw. A subject in the concrete operational stage would not, for instance, incorporate abstract ideas such as the force of gravity or the release velocity of the ball. These abstract concepts are only incorporated by subjects who have attained the formal operational level of development.

Since this study deals with college age students, it is reasonable to assume that all of the subjects in this study have reached the concrete operational stage. Thus, the real distinction we must address is that between concrete operational and formal operational. Piaget indicates that concrete operational thinkers do not engage in abstraction. That is, they work exclusively with concrete representations and operations.

The primary limitations experienced by concrete operational thinkers are abstraction and transfer. That is, concrete operational thinkers experience difficulty with tasks that require abstraction of concrete operations or transfer of operations from one context to another. Piaget identified several classifications of reasoning that are possible only for a subject who has attained the formal reasoning stage. These include, combinatorial reasoning, control of variables, concrete reasoning about abstract constructs, functional relationships and probabilistic correlations (Fuller, Karplus & Lawson, 1977). Each of these involves the manipulation of abstract concepts and is thus beyond the ability of a concrete reasoner.

It is important to note, that concrete reasoners may appear to be engaged in abstract tasks, when in fact they are dealing with the elements concretely. For example, in solving a physics problem, a student may obtain the correct answer by searching through a list of equations for one that contains the variables present in the problem statement. This type of solution involves no abstraction and is within the realm of possibilities for a concrete thinker. On the other hand, if a student utilizes their conceptual and

mathematical understanding of the physics to solve the same problem, she is utilizing abstract general principles that are beyond the ability of a concrete thinker. Thus, in some cases, the ability to solve a particular task may not delineate between a concrete and a formal thinker, but in many cases, the method of solution will.

Piaget's stages of development indicate a particular order in which cognitive skills are acquired. Once a person achieves a particular stage of development, she does not cast off the tools of the previous stage. Obviously, adults still utilize sensory-motor tools to learn. In this sense, the process of cognitive development can be seen as the accumulation of ever more sophisticated learning skills rather than a transition from a primitive set of learning skills to a more advanced set. This point is particularly relevant, when dealing with subjects in more advanced developmental stages. The fact that a subject engages in concrete reasoning behavior (even if formal reasoning would be more effective) does not necessarily indicate that the subject is not able to reason formally. She may choose to use concrete reasoning skills for the purpose of expediency. For example, few people would think of applying abstract algebraic concepts to balance a checkbook. Instead, most people would resort to the simple algorithmic methods they learned in elementary school.

3.3.2 The Vygotskian Approach to Cognitive Psychology

At the core of Vygotsky's cognitive theory is the idea that learning is an inherently social activity. The use of the term social here is meant to emphasize the importance of personal interactions in learning. That is, a novice acquires knowledge by interacting with others (teachers, parents, peers, etc...). Vygotsky believed that learning occurred when the novice, with the aid of a teacher, was pushed to perform beyond his individual capability. The idea being that, with the aid of an instructor, a student can perform tasks which are beyond the level that he can complete independently. And by engaging in these aided tasks, the student extends his ability to perform independently. (Wertsch, 1985)

Clearly there are limits to this type of aided learning. No matter how much assistance is provided, a five year old will not benefit from lessons in quantum field

theory. In addition, reviewing the alphabet with a professor of English literature will result in little cognitive gain. Thus, Vygotsky argued that significant learning gains can only occur if the tasks to be performed by the student are beyond her independent ability, but within her ability when aided by an instructor. According to Litowitz (1993), "Vygotsky called the difference between what a child can do on her own and what she can do in collaboration with a knowledgeable other, the zone of proximal development." The zone of proximal development defines the domain in which learning can occur. One important implication of this idea is that it places boundaries on what can effectively be taught. Clearly, engaging a student in an aided task that the student can perform independently provides little gain. Similarly, engaging a student in a task that is beyond his ability even when aided by the instructor will also provide little cognitive gain.

It is important to note that the zone of proximal development is defined by the particular social context in which learning is to occur. Thus, in the case of a student-instructor interaction, the zone of proximal development is not defined exclusively by the student, but by interaction between the student and instructor. In this sense, the instructor's responsibility is to generate tasks for the student that lie within the zone of proximal development.

Litowitz (1993) outlines a set of steps in the learning process. She claims that in the early stages of the learning process, the student is "carried" by the instructor. That is, the instructor performs most of the task while the novice performs only a small piece of the task. As learning progresses, the student takes over more and more of the task. Finally, the student takes over responsibility for the entire task.

Vygotsky is often cited as one of the initial theoretical advocates of peer collaboration (group work) as a method for learning. In peer collaborative learning, students define the zone of proximal development for each other. More precisely, the interaction between the students defines this zone. Depending on the abilities of the students involved, this peer collaboration can take on one of two forms. If one of the students is of higher ability than the other, the peer collaboration can take on a form similar to the student-instructor interaction described above.

If the students are of nearly equal ability, they each serve as student and instructor. Even though the students are of similar ability, each brings to the task a particular

perspective. Because of this difference in perspective, each student defines the task slightly differently. Since the collaborative process requires that they work together on the task, each must adjust his own definition of the task to accommodate the other. The result is that, even for student of similar ability, each student is able to work beyond the level he could achieve alone. Thus, the role of a peer in peer collaboration in the Vygotskian sense is not to provide correct answers but to help define the zone of proximal development and facilitate each student to achieve beyond their independent learning ability.

Two important aspects of the Vygotskian model of peer collaboration should be noted. First, Vygotsky believed that in order to understand any learning endeavor, it is essential to examine the socio-cultural context. The example given by Forman and McPhail (1993) is that, "two siblings who are asked to wash dishes at home are likely to interact in different ways than two classmates in school who are asked to collaborate in solving a mathematics problem." Thus, the interaction between individuals engaged in a collaborative task is dependent upon their individual backgrounds, their previous personal interactions and the particular context of the prescribed task.

Second, Vygotsky's approach is primarily focused on facilitating cognitive development. That is, it addresses the development of understanding more than the mere acquisition of facts. In this light, the Vygotskian approach is particularly useful to educators in situations where they want their students to develop a comprehensive knowledge structure rather than add bits of information to an existing healthy knowledge structure.

3.3.3 Implications of the theories of Piaget and Vygotsky's for the Junior Year Transition

Four ideas from the theories reviewed above have important implications for understanding the junior year transition. First, Piaget's distinction between concrete and formal reasoning highlights one of the primary changes in our expectations of students as they enter the junior year. As student transition from the lower division to the upper division in physics they are expected to shift from a primarily concrete intuitive

understanding of physics to a formal mathematical understanding. Second, Vygotsky's emphasis on the effects of the social and cultural setting on learning points out the importance of the particular context in which material is presented in upper-division physics. Third, the progression of the students' role in the student-teacher relationship provides a model for how the transition from novice physicist to senior physics major might progress. Finally, Vygotsky's concept of the zone of proximal development provides a theoretical guide for defining the role of the teacher in facilitating a transition. One of the major goals of this research is to provide teachers with information that will help them identify the boundaries of the zone of proximal development for physics majors as they enter the junior year.

It is reasonable to believe that many of the junior physics majors studied here have entered into the formal operational stage of Piagetian development. Success in the lower division requirements for the physics major is unlikely without some formal reasoning skills. This does not however imply that all of the students have reached the formal operational stage or that they all have equal facility with formal thinking. In the junior year students begin to face more and more situations to which they must apply formal reasoning. As they develop expertise in the junior and senior years, they are expected to shift the fundamental structure of their understanding of physics from concrete to formal reasoning. In fact, the ability to decide which methods are appropriate for solving a particular problem may be one of the fundamental characteristics of the expert.

Chi (1982) suggests that expertise is not universal but rather field dependent. This conjecture is supported by Vygotsky's belief that learning is context dependent. Chi and Vygotsky agree that at least some component of cognitive development is dependent on context. This is particularly relevant for the development of expertise in a specialized scientific field like physics. It is not difficult to argue that the development of expertise requires significant intellectual development beyond the simply the ability to reason formally in the Piagetian sense. As physics majors enter the junior year they begin the journey toward developing expertise in physics. From the Vygotskian point of view, the particular development that occurs along this journey is dependent not only on the subject matter that is covered, but also on the social and cultural environment in which this material is covered. Thus, the same material covered in a lecture, a lab and a small group

activity will result in significantly different development in the student. Taking into account that physics graduates will be expected to utilize their physics knowledge in a variety of context, it seems reasonable that they should also learn physics in a variety of contexts.

Vygotsky suggested that the role of the student should change significantly over the course of learning a particular subject or task. He argues that as the novice progresses she gradually takes over more responsibility in performing a particular task until she can perform the task independently. A simple extension of this idea frames the transition that students experience in the junior and senior years of the physics major. In the lower division, students take little responsibility for their overall learning of physics. The topics are chosen by the instructor and the students perform tasks that constitute only a fraction of the physics they are exposed to. Upon entry into the junior year, students are expected to take over more responsibility for developing an understanding of the particular topics they cover. As they progress through the major more and more responsibility is transferred to the student. Eventually, they are expected to be able to choose their own topics of interest and seek out the resources they need to understand the topic. Thus, Vygotsky's model of the student-teacher relationship provides a framework for the stages of the physics major. In this framework, the junior year plays a critical role since, traditionally, responsibility of the student increases sharply during this year. One of the ultimate goals of this research is to develop an understanding of and facilitate this transition.

The concept of the zone of proximal development is a powerful tool for defining the roles of the student and teacher in the learning process. In the Vygotskian framework, the goal of the teacher is to provide a learning environment in which most of the students work within the zone of proximal development most of the time. The idea is that, in this zone, students learn at an optimal rate. Thus, one of the major obstacles faced by the teacher is identifying the zone of proximal development for student. Remember, that the lower bound of the zone of proximal development is defined by the set of tasks that a student can do independently and that the zone of proximal development contains the tasks that students can do with the aid of a knowledgeable instructor. One of the primary goals for future extensions to this research is to better

define the lower bound of the zone of proximal development for incoming junior physics majors. Two of the studies described in this document yield information about the tasks that students can perform independently. The intent of these studies is to characterize students' independent problem solving ability. Instructors may find this information useful as they attempt to identify the lower boundary of the zone of proximal development for their students.

Chapter 4 Measurement of Students' Spatial Abilities

Spatial ability has been recognized as an important component of human intelligence (Guay, 1980). It has been suggested that spatial ability is an important element of mathematical and scientific understanding and creativity. Even so, the importance of spatial ability has been overshadowed by the emphasis placed on verbal and analytic ability. The goal of the study described in this chapter was to assess the importance of spatial ability in the upper-division college physics curriculum. To achieve this goal, we measured the correlation between spatial ability and course grades in junior year physics for 17 physics and engineering-physics students.

To begin, we must first develop a working definition of spatial ability. Two components of spatial ability have been identified in the literature: the perception and retention of visual images and the mental manipulation of these images. While both of these components are important in their own right, the consensus from the literature is that "mental manipulation of objects, not the perception or retention, ... enables a task to measure spatial ability." (Kovac, 1989, p. 27) In physics, a large fraction of the spatial constructs used are representations of abstract entities molded into spatial form to simplify calculations or suggest new directions for problem solving. In these cases, the mental manipulation of these constructs is of primary concern. Thus, the operating definition of spatial ability used here refers to the ability to manipulate mental images. Drawing from Zazkis's definition of visualization, mental images are "internal constructs" that are strongly connected to "information gained through the senses." (Zazkis, Dubinsky & Dautermann, 1996, p. 441) Therefore, mental images are not restricted to visual images, but can include internal constructs related to any of the senses.

Spatial ability has often been considered less important than verbal and analytic ability; however, for certain tasks it has been shown to play a substantial role. In particular, spatial ability has been linked to achievement in mathematics, science and engineering courses (Siemankowski & MacKnight, 1971; Burnett & Lane, 1980). In addition, Burnett, Lane and Dratt (1979) found that the well-documented dependence of mathematical ability on gender could be explained by differences in spatial ability.

Several studies have shown that specific training can improve subjects' spatial abilities (Stericker & LeVesconte, 1981). Burnett and Lane (1980) studied the improvement in spatial ability of 142 students between their first term in college and the spring term of their sophomore year. They showed that subjects in mathematics and physical science courses showed significant improvement in their scores on spatial ability tests after the first two years of college instruction.

It has been shown that spatial training can result in improvement in advanced mathematics (Mundy, 1987) and chemistry (Small, 1983) performance. Pribyl and Bodner (1985) also found a strong correlation between spatial ability and performance in chemistry.

No similar studies have been done to measure improvement in physics performance due to spatial training. In addition, no studies have specifically addressed the correlation of achievement in physics and spatial ability. It is reasonable, however, to believe that such a correlation does exist. Visualization is an integral part of advanced physics knowledge. Professional physicists often use complex spatial/visual constructs to better understand the physical world. Concepts like fields and constructs like graphs and diagrams are essential tools for the professional physicist. For example, the introduction of Feynman diagrams in the 1960s revolutionized the study of field theories by providing a simplified language for discussing and calculating complex perturbation integrals. The concepts and ideas of physics are couched in the language of mathematics. Research has shown that mathematical ability is strongly correlated with spatial ability (Burnett, Lane & Dratt, 1979). Based on this research, it is reasonable to suggest that spatial ability plays a significant, if possibly indirect, role in understanding of physics.

The goal of the study described in this chapter is to examine the extent of this role. In particular, we measure the correlation between students' spatial ability and their success in the junior-year Paradigms in Physics curriculum. We also measure how this correlation varies among the Paradigms courses.

4.1 Sample

The sample consists of physics and engineering physics majors at Oregon State University. The sample contains 17 students, including all of the junior physics majors and about half of the junior engineering physics majors. Five senior physics and engineering physics majors participated in the study, but because of their small numbers, this data was not included in the quantitative analysis. All subjects were volunteers participating in a one-week wrap up class at the end of the junior year physics courses. The sample consisted primarily of white males, reflecting the standard demographics of physics majors at Oregon State University. Only one female student participated in the study. The average incoming math and physics GPA was 3.00. Ten of the 17 subjects had completed at least 30 credit hours at another institution

4.2 Choice of Measurement Instrument (PSVT)

The Purdue Spatial Visualization Test (PSVT) was chosen to measure subjects' spatial ability based on a review of the literature. Our choice of the PSVT was based on the following criteria. The test had to

- Be a paper and pencil test
- Be short enough to be administered in one 50 minute class
- Have evidence for its reliability and construct validity available in the literature
- Involve minimal reading and writing on the part of the test taker

Logistical considerations forced the requirement that the instrument be a paper and pencil test that could be administered in a 50-minute class. Other types of test were considered including computer based tests and 3-D manipulative based tests, but were rejected because they required unacceptable amounts of time or unavailable resources.

Evidence for the reliability of the PSVT was presented in Guay (1980). Three studies involving groups of 217 university students, 51 skilled workers, and 101 university students yielded KR-20 internal consistency coefficients of 0.87, 0.89 and 0.92

respectively. These high reliability coefficients suggest that for university students the PSVT is a reliable measurement instrument.

The validity of the PSVT was explored by both Guay (1980) and Kovac (1989). Both studies warn that paper and pencil tests have a limited ability to measure spatial ability in isolation. In particular, they report that test takers often use analytic methods (trial and error, guessing, use of a characteristic part, etc...) to solve items on spatial abilities tests. For tests where this is common, a high score does not necessarily indicate high spatial ability, but instead may suggest high analytic ability. Guay's analysis of student self reports revealed that students used primarily spatial thinking while solving items on the PSVT. In contrast, he found that analytic strategies were common methods of solution for items on the Revised Minnesota Paper Form Board Test, another common test of spatial ability.

Kovac (1989) investigated the construct validity of three commonly used tests of spatial ability: the spatial relations part of the Differential Aptitude Test (DAT) battery, and the Visualization of Rotations (PSVR) and Visualization of Views (PSVV) parts of the Purdue Spatial Visualization Test. As part of this study, Kovac conducted think-aloud interviews with 28 male and 30 female students as they worked through two items on each of these tests. He found that in the case of the PSVV and PSVR tests the majority of subjects used spatial strategies (user-reorientation, object-reorientation, rotation of whole object, visual walk around, etc...) However, he also found that a sizeable portion of the subjects used analytical methods (trial and error, guessing, use of a characteristic part, etc...) to solve these test items. Kovac observed the majority of subjects used analytic methods to solve the items on the DAT.

These results indicate that the items on the PSVT are less susceptible to solution by analytic methods than other standard tests of spatial ability. At the same time, it is important to note that the ability of any paper and pencil instrument to measure spatial ability is limited.

Finally, we required that the spatial abilities test involve little reading and writing on the part of the test taker and that the test include a variety of types of testing items. These criteria are in essence a test of construct validity. Tests that involve much reading and writing inherently rely on the reading/verbal ability of the test taker. In the type of

timed environment used on these exams, variations in subjects' verbal abilities can significantly affect test scores. The requirement that various types of items be represented on the test ensures that some breadth of spatial abilities is tested by the instrument.

The short form of the PSVT meets each of the requirements stated above. A 36-question paper and pencil test, the PSVT requires approximately 45 minutes to administer. The PSVT consists of three, 12 question sections, each containing a different type of item. The first section, "Visualization of Developments," involves tasks that required subjects to construct three-dimensional solids by mental folding processes. In the second section, "Visualization of Rotations," subjects predict how a solid will appear when rotated in a given manner. In the final section of the test, "Visualization of Views," subjects predict what an object will look like from a different point of view. A copy of the PSVT can be found in the ETS test collection (Guay, 1976). As we outlined above, the PSVT has high reliability and sound if not perfect construct validity (Kovac, 1989; Guay, 1980; Guay, 1976).

4.3 Data Collection Procedures

Data was collected on spatial ability (PSVT score), incoming math and physics grade point average (GPA), sex, and course grades in the Paradigms for each subject. Subjects were administered the short form of the Purdue Spatial Visualization Test (PSVT) (Guay, 1976) during the last week of classes of the third term of their junior year. Demographic and grade records were obtained from student transcripts.

The PSVT was administered according to the instructions accompanying the test. Before each section the instructions for completing the items in that section were read, two examples were worked through and subjects were given the opportunity to ask questions. Subjects were given 12 minutes to complete each section. Because of the documented difficulties in measuring the different axes of spatial ability (Borich & Bauman, 1972) I chose to combine the scores from the three sections to give an overall spatial abilities score. The final page of the PSVT consisted of a set of demographic

questions. Since these questions were not deemed important for this study, students were given the option of not completing this page. The score on the PSVT is just the number of items answered correctly.

Discussions with students after the test indicate that the test may not minimize analytic thinking to the extent that was suggested by the author. Several students were overheard discussing the PSVT after class. When asked about it two students indicated that they completed the items in each section by focusing on a single part of the objects as opposed to the whole. While no formal analysis was done, these comments suggest that some students may have used analytic methods while working through the items on the PSVT.

The remaining data, grades in each of the Paradigms courses, incoming math and physics GPA and sex, were collected from each student's transcript. Grades were converted to numerical format on the standard 4.0 scale. Incoming math and physics GPA was calculated from all math and physics courses, resident or transfer, prior to taking Physics 321 (the first course of the junior year).

4.4 Data Analysis

Two correlation measurements were made to examine the relationship between subjects' spatial ability and performance in math and physics. The first measurement was a simple regression analysis relating scores on the PSVT with subjects' incoming math and physics GPA. The second measurement consisted of a multiple regression analysis correlating students' performance in each of the Paradigms courses with PSVT score, incoming math and physics GPA and sex. In each case a 95% confidence ($\alpha = 0.05$) was required for statistical significance of any value.

In the first measurement a simple regression analysis was performed. The data were fit to a simple linear model.

$$Y_{GPA} = b_{PSVT} X_{PSVT} + a \quad (4.1)$$

In addition to determining best fit values for b_{PSVT} and a , the Pearson's R^2 statistic was calculated. The value of Pearson's R^2 statistic indicates the fraction of the variance that is accounted for by the model. Thus, an R^2 of 1.0 indicates that the model accounts for all of the variation in the data set and an R^2 of 0.5 indicates that the model accounts for half of the variation in the data set.

Finally, an analysis of variance was done to determine if the R^2 value was significantly different from zero. The analysis of variance yields a p value which indicates the probability that the R^2 value could be equal to zero by chance. This chance arises since our data is derived from a sample of the population rather than the population itself. In order to determine whether R^2 is statistically different from zero, we compare the p value obtained from the analysis of variance to α . Thus if p is less than or equal to α (0.05 in this study), we conclude that the value we obtained for R^2 is statistically different from zero within the tolerances of our predefined confidence interval. In this case we would deem the value of R^2 statistically significant and proceed to use this value to draw conclusions. In the event that our p value is greater than α , we would reject the value for R^2 as not statistically significant, indicating that our data set was not sufficient to determine R^2 within our predefined confidence interval. Throughout this analysis, we compare the p values for various quantities to our predefined α in order to determine whether or not these quantities are statistically significant.

The second measurement consisted of a multiple regression analysis. In this analysis, students' PSVT score, incoming math and physics GPA and sex constituted the independent variables used to predict their grades in each of the nine Paradigms courses. Thus, nine multiple regressions were performed. The linear model for each regression was the form shown in Equation 4.2.

$$Y_{Grade} = b_{PSVT}X_{PSVT} + b_{GPA}X_{GPA} + b_{Sex}X_{Sex} + a \quad (4.2)$$

As in the first measurement, values for b_{PSVT} , b_{GPA} , b_{Sex} , a , R^2 and $p(R^2)$ were calculated. In addition, the squares of the semipartial correlation coefficients (sr_{PSVT}^2 , sr_{GPA}^2 and sr_{Sex}^2) and their respective p values were calculated to determine how important each of the elements of the model was in predicting students'

grades. These sr_i^2 values were calculated by subtracting the R^2 value, R^2_{j+k} , obtained from a linear regression excluding the element i from the total R^2 value, R^2_{i+j+k} obtained from the regression containing all three elements. Thus,

$$sr_{PSVT}^2 = R^2_{PSVT+GPA+Sex} - R^2_{GPA+Sex} \quad (4.3)$$

$$sr_{GPA}^2 = R^2_{PSVT+GPA+Sex} - R^2_{PSVT+Sex} \quad (4.4)$$

$$sr_{Sex}^2 = R^2_{PSVT+GPA+Sex} - R^2_{PSVT+GPA} \quad (4.5)$$

The sr_i^2 value indicates the amount by which R^2 increases when the variable i is added to the model. In other words, sr_i^2 , is a measure of the fraction of the variance of the data set accounted for by the independent variable i beyond that accounted for by j and k . (Cohen & Cohen, 1975) Thus, a value of sr_i^2 equal to 1.0 would indicate that the predictor i accounted for all of the variance in the data. In this case, it would be silly to include j and k as predictors since, a simpler model including only i could accurately predict all of the variation in the data set. The quantity sr_i^2 then is an indication of the importance of the variable i to the model. Since a low value of sr_i^2 indicates that the inclusion of the variable i in the model only changes the total R^2 by a small amount. Whereas a large value of sr_i^2 indicates that the inclusion of the variable i in the model causes a large change in the total R^2 .

Subjects' score on the PSVT was correlated to their overall GPA and to their grades in each of the Paradigms courses. Since we are using grades as a measure of students' performance in each class, we can only relate students' spatial ability and their performance on the evaluation mechanisms in each class. It should be noted that the number of subjects was not constant for all of the regression analyses because some students did not take all of these courses included in this study. Conclusions drawn from this research will be limited by the fact that no effort has been made to validate these evaluation mechanisms.

4.5 Results

Average grades for each of the Paradigms courses are tabulated in Table 4.1. The average score on the Purdue Spatial Visualization Test was 31 with a standard deviation of 4.

Course	PH321	PH322	PH323	PH424	PH425	PH426	PH427	PH428	PH429
Avg. Grade (0-4)	3.41	2.89	2.88	2.94	2.55	2.39	3.16	3.38	2.96

Table 4.1 - Average grades in each of the Paradigms courses (0-4).

Reliability of the PSVT with this sample (N=17) was estimated with the Kuder-Richardson (KR 20) formula to be 0.818. In some sense, this value yields an estimation of the measurement error associated with this test and this particular sample. A reliability value close to one indicates that the variation associated with responses to individual questions is small compared to the variation in the total score. This suggests that the measured scores are close to a hypothetical “true score”. The reliability value of 0.818 obtained here is high enough to suggest that the PSVT is a reasonably reliable instrument. As indicated in Section 4.2, Guay (1980) measured the reliability of the PSVT for two groups of college students (N=217 and N=101) and one group of skilled workers (N=51). These measurements resulted in KR-20 coefficients of 0.87, 0.92 and 0.89 respectively. The reliability coefficient measured in this study is comparable to these values, further suggesting that the measured PSVT scores are a reliable reflection of subjects’ “true scores.”

4.5.1 Correlation between Spatial Ability and GPA

A simple regression analysis was done to estimate the degree of correlation between spatial ability and subjects’ incoming math and physics grade-point average.

The regression yielded an R^2 of 0.272 ($F=1.495$, $p=0.266$). Comparing this p value to our α criterion, it is clear that this result is not statistically significant. In addition, you can see in Figure 4.1 that there is no obvious correlation between PSVT score and incoming math and physics GPA.

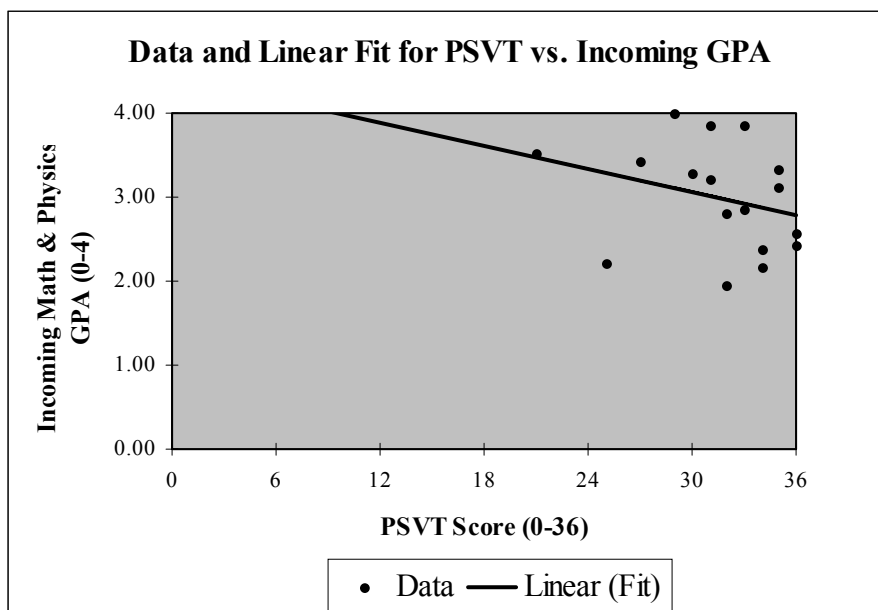

Figure 4.1 - Plot of the linear fit obtained from the PSVT vs. incoming math and physics GPA regression analysis.

4.5.2 Multiple Regression Analysis for Predicting Course Grades

The results of the multiple regression analysis are tabulated in Table 4.2. Each row of the table corresponds to an independent regression analysis for each course.

Examination of the p values reveals that the R^2 values for PH321, PH322, PH428 and PH429 are not statistically significant and that the R^2 values for PH323, PH424, PH425, PH426 and PH427 are statistically significant. In each of the statistically significant cases, the R^2 indicates that the model used accounts for roughly half of the variance in grades given in the course.

Course	N	R	R ²	F	p
321	16	0.522	0.272	1.495	0.266
322	16	0.429	0.184	0.903	0.468
323	17	0.781	0.610	6.766	0.005
424	16	0.720	0.519	4.312	0.028
425	17	0.667	0.444	3.464	0.048
426	17	0.676	0.458	3.655	0.041
427	17	0.724	0.525	4.787	0.018
428	16	0.463	0.215	1.093	0.390
429	15	0.642	0.412	2.565	0.108

Table 4.2 - Tabulation of statistics from a multiple regression predicting course grades with a linear model including spatial ability (PSVT score), incoming math and physics GPA and sex.

Course	sr _{PSVT} ²	p	sr _{GPA} ²	p	sr _{Sex} ²	p
321	0.140	0.581	0.222	0.385	0.023	0.927
322	0.105	0.694	0.136	0.610	0.007	0.980
323	0.004	0.983	0.465	0.019	0.005	0.979
424	0.005	0.982	0.386	0.078	0.004	0.984
425	0.073	0.729	0.423	0.062	0.026	0.900
426	0.028	0.895	0.438	0.052	0.026	0.902
427	0.008	0.968	0.287	0.158	0.042	0.830
428	0.022	0.934	0.208	0.433	0.072	0.784
429	0.009	0.969	0.326	0.187	0.000	0.999

Table 4.3 – Tabulation of the squares of the semipartial correlation coefficients (sr_i^2) and their p values for a linear model including spatial ability (PSVT score), incoming math and physics GPA and sex as predictors for class grades.

Examination of the p values in Table 4.3 reveals that only one of the sr^2 's is statistically significant. The sr_{GPA}^2 value of 0.465 for PH323 is statistically significant, indicating that almost half of the variation in students' grades in PH323 is predicted by their incoming math and physics GPA. None of the sr^2 values for the PSVT and Sex variables are statistically significant. The small sr^2 values for these variables indicate that they contribute very little to the overall predictive ability of the model. The large $p(sr^2)$ values (that is, the p values associated with the sr^2 statistics) for these variables indicate a high probability that the measured sr^2 values are different from zero only by random chance.

Even though only one of the sr^2 's was statistically significant, there is some evidence that a correlation between incoming math and physics GPA and grades exists for several of the Paradigms courses. As indicated before, the overall R^2 values for PH424, PH425 and PH426 were statistically significant. While the sr_{GPA}^2 values for these courses were not statistically significant, their p values indicated that they were close to statistical significance. In addition, the sr_{GPA}^2 values themselves indicate that GPA was the dominant predictor in the model for these courses. The dominance of GPA as a predictor was corroborated by plots of the measured data vs. fit from the multiple regression. Figure 4.2 and Figure 4.3 illustrate this. These plots show projections of the four dimensional (Incoming Math and Physics GPA, PSVT Score, and Sex vs. Course Grade) dataset. Each data point (\bullet) has a corresponding fit value ($+$) that indicates the predicted value of Course Grade (y-axis value) for each value of the independent variable (x-axis) in the measured dataset. Thus, the plots below contain pairs of data points (\bullet - measured and $+$ - fit) for each value of the independent variable contained in the measured dataset.

Figure 4.2 shows the projection of the three dimensional linear fit and the measured data onto the incoming GPA vs. course grade axes for PH424. This plot suggests a reasonable correlation between these variables. Figure 4.3 shows the projection of the fit onto the PSVT vs. course grade axes. This plot clearly indicates that there is little correlation between these variables.

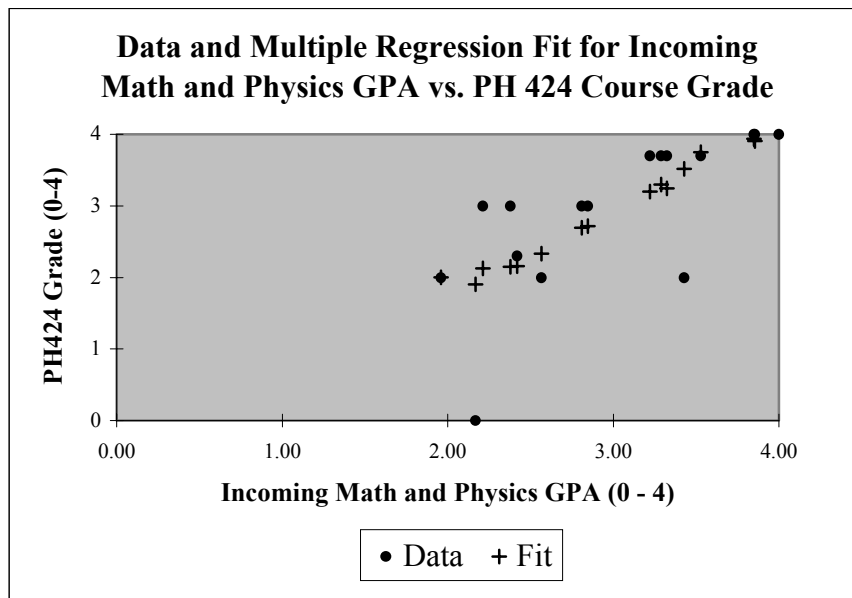

Figure 4.2 - A plot of measured data and the fit values from a multiple linear regression. The plot shows the projection of this four dimensional data set onto the Incoming Math and Physics GPA and PH424 course grade axes.

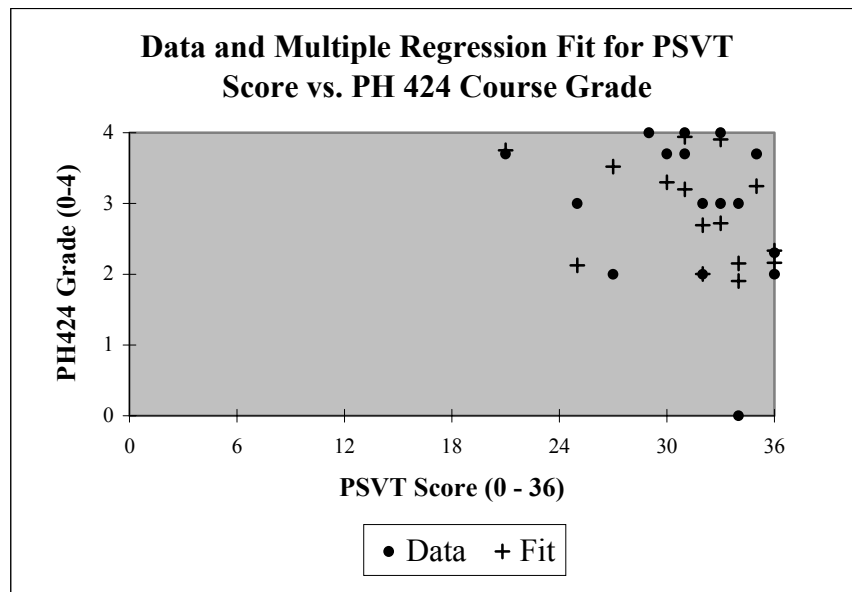

Figure 4.3 - A plot of measured data and the fit values from a multiple linear regression. The plot shows the projection of this four dimensional data set onto the PSVT score and PH323 course grade axes.

4.6 Conclusions

The results of this study indicate that the correlation between spatial ability and grades is small in this sample. At first glance, this seems to indicate that the ability to visualize has little impact on success in upper-division physics. However, two factors need to be taken into account before drawing this conclusion.

First, the average score on the PSVT was 31 ($\sigma = 4$) out of 36 with all but four students scoring above 30. Thus, the variance in spatial ability scores was quite small. This data suggests that the spatial ability of the students in this sample was quite high. Since none of the available references for the PSVT reported average scores, we were not able to make any comparison between our samples and a typical average. It is possible that performance in upper-division physics is dependent on spatial ability, but only up to a certain level. That is to say, success in physics likely requires some level of spatial ability. However, it may be that subjects who have a higher than required spatial ability experience very little increase in performance. Assuming this is true, it is possible that most of the subjects in this study have a spatial ability above this proposed threshold.

Second, the PSVT is designed to only measure student's spatial ability. Thus, the PSVT does not test subjects' ability to utilize visual information to solve problems. It may be that the two skills are quite separate. In any case, the PSVT is intended only as a measure of pure spatial ability and does not provide any information about subjects' ability to apply spatial skills.

Thus, our data suggests that students' spatial ability does not correlate significantly with student grades in physics. However, the limited sample size in this study and the small spread in PSVT scores prevent us from making more general statements about the importance of visual ability in learning physics.

The only statistically significant correlations measured in this study indicate that for some courses (PH323, PH424, PH425 and PH426), GPA is correlated with

subjects' course grades. This result is not surprising since incoming GPA is a direct measure of past performance in other classes. Assuming that the requirements of PH 323 are similar to those in other math and physics classes, it is reasonable to expect a strong correlation between incoming math and physics GPA and any course grade in physics. Why then do we not see statistically significant correlations between incoming GPA and other Paradigms courses? The answer to this question lies in the fact that our sample is very small. Close examination of a combination of factors (R^2 , sr^2 , and projection plots of the data) suggests that with a larger sample, the correlations between incoming GPA and course grades is likely to be statistically significant.

Chapter 5 Research Design

The following two chapters include descriptions and analyses of data collected from student interviews. In this chapter, our goal is to describe and motivate the particular data collection methods used. In Section 5.1, we discuss the motivation behind our choice of the think-aloud methodology and discuss in some detail its strengths and limitations. In Section 5.2, we discuss the particulars of our research design.

The field of physics education has been well established at the lower-division level, however, little research has been done to understand the thinking and learning of upper-division physics students. In our review of the literature in several related disciplines, we found no sources that specifically studied problem solving in upper-division physics. Thus, the studies presented here are forays into a new field. In such a young field, the important questions have yet to be clearly defined. It is the goal of this research to begin defining these questions. In doing so, we would like to base our questions as much as possible on observations of students' behavior. This type of study, in which questions and hypotheses are derived from observations, is called emergent research, in the sense that the questions emerge from the data.

While it is common for researchers to base questions on anecdotal classroom observations, this type of informal observation is of limited utility as a research tool. Informal observations are often misleading for several reasons. They often rely heavily on memory. If the observer decides later that she wants a particular piece of information, there is no complete record to reference. In addition, since informal observations must be remembered, they are inherently biased. That is, the observer automatically makes choices about what she thinks are the important events and details to remember. Thus, the observer applies her own interpretations to the observed events as they are recorded. This last obstacle is critically important in emergent study. In this type of study, we try to delay interpretation

until obvious patterns emerge from the data. These patterns are then used to define the questions and hypotheses. In the case of informal observation, data collection and interpretation become hopelessly blurred.

In contrast, a methodical qualitative study can be designed to minimize the biases and subjectivity inherent in observational research. This is typically achieved by structuring observations so that the information that is gathered is reasonably uniform across different observations and different subjects. In many cases, observations are audio or video taped. These records are then transcribed to provide a record of the observation that is largely removed from distracting details that can lead to bias.

There are a variety of qualitative research methods to choose from, each having its own advantages and limitations. In designing a study, we try to choose a methodology that will allow us to obtain the information we want while minimizing the bias and subjectivity inherent in qualitative research.

5.1 Think-Aloud Interviews

In Chapters 6 and 7, we describe two studies designed to characterize students' use of visualization while solving complex physics problems. Our goal in these studies was to learn as much as possible about what students are thinking while they are solving complex problems. In particular, we were interested in learning about the role of visualization in students' thinking while they were problem solving. In order to achieve these goals, it was essential that our observations provide access to students' thinking but not significantly perturb their problem solving process.

We chose the think-aloud method because it is the most straightforward method for obtaining information from subjects about their thinking process. In addition, it was possible to structure the think-aloud interviews so that the

interviewer's input was minimized and the subject maintained substantial control during the interview.

Think aloud interviews afforded several advantages over other possible data collection methods. First, since we videotaped the interviews, students' drawings and writings as well as verbal statements were recorded and the sequence of events was preserved. Thus, it was possible to examine the interaction between written and verbal information in the interviews. This would not have been possible by examining written responses.

Two interview types were considered: think-aloud interviews and reflective interviews. In a think-aloud interview, subjects are asked to explain their thoughts as they are thinking. In contrast, subjects in a reflective interview are asked to explain a problem they have already solved. The disadvantage of reflective interviews is that, since subjects describe their thinking process after the fact, they may not remember everything they were thinking while solving the problem. This problem is minimized in think-aloud interviews since subjects' explain their thoughts as they are thinking. However, the think-aloud method has the disadvantage that verbalizing the thought process can affect it. That is, subjects thinking process may be distorted by the act of verbalizing their thoughts. This difficulty is minimized in reflective interviews since subjects are able to solve the problem unfettered and report on their thinking only after having solved the problem. We chose think-aloud interviews over reflective interviews because we deemed the issues of interference by the interview method less important than the problems resulting from belated self-reports.

The interview format was particularly suited to our goals since it promised to provide some access to students' thinking processes. Since our goal was to explore the ways that students use visual representations while problem solving, we felt that it was important to encourage students to express the thought process behind their decision making. In addition, we hoped that the think-aloud method would more clearly expose students' confusion and internal conflict during the problem solution. Of the methods we examined, the think aloud method was the only

method for getting information from students about what they are thinking while they were solving problems.

Still, the think-aloud method has some limitations. First and foremost, subjects' behavior may be affected by the think-aloud environment. They may be more aware of what they say or they may resist thinking aloud altogether. Some may reveal more in what they say than others, generating an imbalance in the response data. For example, one student may describe a picture he envisions while solving the problem. Another student may have a similar picture, but neglect to mention it. Thus, the information gained from think-aloud interviews is difficult to analyze quantitatively. The information obtained from think aloud interviews is not a complete description of what the subject is thinking, but instead is filtered by what the subject thinks is important and what the subject thinks the interviewer wants to hear as well as unrelated subject behaviors including those initiated by the stress of the interview situation.

In addition to these limitations, some students just do not like to talk while they are solving problems. For some it is a distraction; for others, it significantly changes their thinking process. Some subjects do not talk much during the interviews and the insistence on the part of the interviewer that they explain their thoughts is an interruption that breaks the train of thought. In contrast, some students interact with the interviewer too much. These students either try to extract information from the interviewer or use the dialogue with the interviewer to reason through the problem in a manner that is uncharacteristic of their normal problem solving. The important thing to note about think-aloud interviews is that, while they provide unparalleled access to students' thoughts, the think-aloud environment is different from the environment in which the student typically solves problems.

5.2 Interview and Transcript Procedures

In the studies presented here, the interviews were videotaped in order to obtain an unbiased account of the events that transpired. In addition, several other safeguards were included in the research design to limit bias. First, interview protocols were designed for each set of interviews to maintain a uniform interview setting. The interview protocols were loose enough to allow the interviewer to follow up on statements the students made and to allow for individual differences in students' problem solving methods. The interview protocols for the preliminary and final interviews are described in detail in Sections 6.2 & 7.2 respectively.

In order to ensure that the interviews were recorded completely, each interview was video taped and meticulously transcribed. In addition to a record of the dialogue, these transcripts included all of the students' drawings and indications of their hand gestures.

Chapter 6 Preliminary Interviews

In fall term of 1999, we conducted a set of think-aloud interviews to learn about students' use of visualization in problem solving. In this chapter, we describe the administration and results of these interviews. This set of interviews was performed as a pilot study for a more extensive set of interviews described in Chapter 7.

6.1 Sample

The unusual nature of the Paradigms curriculum places some limits on the generalizability of this study. However, since the subjects were interviewed during their first term in the Paradigms, it is unlikely that this curriculum has greatly changed their problem solving strategies.

A sample of seven subjects was selected from a class of 25 physics and engineering physics majors at Oregon State University. The subjects were purposefully selected to obtain a range of different problem solving styles from visual to non-visual. The selection process consisted of a brief conversation between the author and the instructor for PH 322. While seven subjects were selected for the study, only five were willing to participate. Each of the remaining five volunteers was given a pseudonym (Royal, Dean, John, Tom and Dan). Each of the subjects had taken Physics 322, a course in static vector fields. Grades for the five subjects studied here are listed in Table 6.1. The average incoming math and physics GPA of the sample was 3.09 compared to 2.95 for the entire junior class. Statistics on the individual subjects are tabulated in Table 6.1. While the sample consisted entirely of white males, the sample accurately reflected the overall demographics of physics majors at Oregon State University.

During the last week of their junior year, four of the subjects participated in the study described in Chapter 4. During the course of that study, the subjects were administered the Purdue Spatial Visualization Test (PSVT), a general measure of spatial ability. Subject's scores on the PSVT are included in Table 6.1. PSVT scores for the sample ranged from 25 to 36 compared to a range of 21 to 36 for the entire class. Thus, the spatial abilities of the subjects chosen for this study reflected the spatial abilities of the class as a whole.

Pseudonym	GPA (0-4)	PH322 Grade	PSVT (0-36)
Royal	3.85	B-	31
Dean	4.00	A	29
John	2.96	A	NA
Tom	2.42	B-	36
Dan	2.21	B-	25
Class Average	2.95	B	31.4

Table 6.1 - Tabulation of subjects GPA, grade in the Static Vector Fields course (PH 322) and score on the Purdue Spatial Visualization Test.

6.2 Data Collection and Interview Protocol

The author interviewed each of the subjects in the preliminary study once during week eight of their first term as an upper-division student in physics. The interviews followed a think-aloud format in which the subjects were asked explain their reasoning as they solved a problem in electrostatics. Subjects were not allowed access to reference materials including books and notes except were noted. Interviews typically lasted one hour.

At the beginning of each interview, the interviewer described the think-aloud structure of the interview. The interviewer explained that questions he would ask were intended to elicit more information about the student's thinking process and should not be interpreted as guiding the student in any particular direction. Subjects were instructed to explain their reasoning as they worked and were encouraged to work at the board. The interviewer also encouraged the students to ask him any questions that came to mind, but warned them that he would not necessarily answer all questions. Subjects were then asked to solve the following problem.

Find the electric field everywhere outside an infinitely long charged cylinder of radius a and constant charge density ρ .

As they worked through the problem, the subjects were regularly asked to explain aspects of their thinking process. If asked, the interviewer would supply equations the subjects could not remember. Since the subjects were generally not able to remember the names of the equations, the interviewer often completed equations the subjects had begun.

Subjects were allowed to pursue their own method of solution for the first 25 minutes of the interview. During this time, each of the subjects attempted to solve the problem using Coulomb's Law. At the end of 25 minutes, the interviewer suggested that the student try to solve the problem using Gauss's law. After 25 more minutes had passed, the interviewer asked a series of follow up questions probing the subjects' previous knowledge of this problem and general problem solving methodology. Finally, as part of the Paradigms evaluation, subjects were asked for general input about the Paradigms program.

6.3 The Interview Problem

The problem used in the interviews was chosen for several reasons. First, this problem allowed the use of several different types of visual strategies. Visual strategies were not required for the correct solution of this problem, however, since the solution involves fields and vector quantities it is likely that most students will use at least some visual elements in their solution. In addition, solution methods that utilized visualization were likely to require less memorization of specific formulae. Coulomb's Law and Gauss's Law were taught in PH322 using a combination of visual and symbolic constructs. Second, the solution to this problem was sufficiently complex to allow the investigation of students' use of visualization in the context of a difficult problem typical of those students encounter on their homework or exams. Using a collection of several shorter/simpler problems was considered but rejected because students might use different methods for solving shorter problems. Since the goal of this study was to explore how upper-division students use visualization in their problem solving, we chose to use a problem similar in complexity and difficulty to those the subjects had seen in class and on homework.

The problem used in these interviews can be solved in one of two ways, with Coulomb's Law or with Gauss's Law. The final form of the Coulomb's Law solution is an integral that cannot be easily evaluated. Gauss's Law yields a closed form expression for the electric field after evaluating only relatively simple integrals. All of the subjects interviewed chose to attack the problem with Coulomb's Law and used Gauss's Law only when it was suggested by the interviewer.

Since our goal was to describe their methods of solution, the correctness of subjects' final solutions was not particularly important in this study. However, it is worthwhile to briefly describe the level of success each subject achieved. Solutions to the problem varied widely. None of the subjects was able to solve the problem correctly and completely. However, Dean's solution was nearly correct. After

being prompted to use Gauss's Law, he produced a solution that was different from the correct solution only because of a trivial algebra error. Dan also generated a nearly correct equation for the electric field. In Dan's case, however, he was given more assistance and made a variety of incorrect assumptions and arguments to get to the answer. In addition, Dan did not trust this equation and eventually discarded it as flawed. The others achieved varying degrees of success on different parts of the problem but obtained solutions with significant flaws.

In several instances, the subjects encountered difficulties that prevented them from continuing. In most cases, encouragement and open-ended questions from the interviewer, e.g., "What do you think you should do next?" prompted them to proceed. In some cases, however, the interviewer provided help in the form of equations or affirmation of student results. In most cases, these interventions occurred near the end of the interviews. Each instance was identified in the transcripts and the possible effects of each were considered when analyzing data following an intervention.

6.4 Results/Analysis

The analysis of these interviews revealed that subjects used a combination of visual and symbolic methods in solving the problem proposed. The goal of this analysis was to develop a structure for exploring the ways that students use visualization in problem solving. We recognized early on in the analysis that students often used visual and symbolic methods together. Thus, an accurate description of the visual problem-solving behaviors of these students must also include some discussion of their use of symbolic methods.

Only one study found in the literature explores a model of the interactions between visual and non-visual steps in complex problem solving (Zazkis, Dubinsky and Dautermann, 1996). The V/A model describes problem solving as a series of alternating visual and analytic steps leading ultimately to the problem solution. In

describing their V/A model, Zazkis, Dubinsky and Dautermann chose definitions of visualization and analysis that explicitly refer to internal thought structures. They define visualization as “an act in which an individual establishes a connection between an internal construct and something to which access is gained through the senses.” Similarly, they define analysis as “any mental manipulation of objects or processes with or without the aid of symbols.” In the analysis of our data, we found it very difficult to identify “pure” analysis steps as identified by Zazkis, Dubinsky and Dautermann. A review of their definitions for visualization and analysis revealed that both were couched in the terms of internal mental structures. Our difficulty in identifying “pure” analysis steps stemmed from the inherent complexity of observing internal mental constructs.

In light of these difficulties with the V/A model we have begun to develop a similar model based on more easily observable problem-solving steps. Our goal in this study is similar to that of Zazkis, Dubinsky and Dautermann in that we would like to describe the interplay of visual and non-visual processes in problem solving. However, we concluded that for our purposes, the distinction between visual and symbolic methods was more relevant than the distinction between visualization and analysis.

6.4.1 Definitions

In an effort to simplify and clarify our analysis, we define a number of terms. These definitions were chosen in an attempt to identify elements of the problem-solving process that were both useful and easily observed.

- *Visual Image* - For the purposes of this study we will adopt Presmeg's (1992) operational definition for a visual image. "A visual image is defined here simply as a mental construct depicting visual or spatial information. This definition is deliberately wide enough to include 'pictures-in-the-mind'...as well as more abstract forms...."
- *Visualization* - is the act of generating, manipulating or utilizing a visual image as defined previously.

- *Visual elements* - are pieces of a visual image that depict visual or spatial information.
- *Symbolic elements* - are letters, numbers or mathematical symbols used to identify an element of the problem.

The definitions of visual and symbolic elements are not intended to be mutually exclusive. For example, if an element of a drawing is labeled with a symbol, this label behaves as both a visual and a symbolic element. While the generalizability of these definitions is somewhat restricted, they are well defined in the context of this study.

6.4.2 Visual and Symbolic Steps

To examine subjects' problem-solving approaches in more detail, we have chosen to break them down into individual steps in the spirit of the Zazkis analysis (Zazkis, Dubinsky and Dautermann, 1996). In contrast to the visual and analytic steps in the V/A model, we have chosen to categorize steps as either visual or symbolic. Our definitions for visual and symbolic steps were chosen to facilitate straightforward classification of steps in the transcripts.

Visual steps are defined as steps that explicitly reference visual images. A step was identified as visual if it involved any references to pictures or mental images or if it involved kinesthetic visual references (hand motions, etc...). Visual steps often entailed drawing a diagram, modifying a diagram or making a symmetry argument with the aid of a diagram. For the purposes of coding, visual steps were marked with a **V**.

Symbolic steps are defined as steps that contain explicit references to symbolic elements. A step was identified as symbolic if it involved references to equations, formulae or other symbolic constructs. Symbolic steps include formula recall, algebraic manipulation, equation substitution, etc... For the purposes of coding, symbolic steps were marked with an **S**.

In addition to drawing a distinction between visual and symbolic processing, we have also delineated between what we call initialization (**I**) and processing (**P**) steps. These distinctions are adapted from computer jargon. Initialization steps are those steps where new information is inserted into the problem from the outside, e.g., the recall of an equation. Processing steps involve the manipulation, analysis or synthesis of elements in the problem.

Some examples may help clarify these distinctions. Most often, initialization steps occur at the beginning of a problem. For example, two of the first three steps in Dean's solution were initialization steps. (Note the coding symbols on the left)

The first step was a visual initialization step (**VI**). Dean drew a diagram depicting the physical situation in the problem based on the problem description. In the third step, he recalled the equation for the potential due to a charge distribution (**SI**) and wrote that down. The second step (**?P**) was not as straightforward, so it will be dealt with later in this section.

- VI** Dean: So I have a cylinder. This goes out like this. (drawing three horizontal lines at each end to indicate that the cylinder continues on) This is going to be along the z-axis. And I want to use cylindrical coordinates, because it makes sense. This is a cylinder.
- ?P**

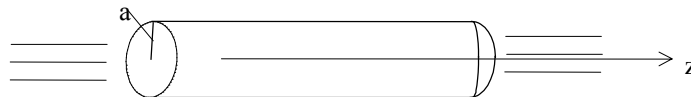

- SI** Dean: Okay, let's see. It's infinite, so the first thing I want to do is find the potential. And that is V at some r is equal to ... (says equations as he writes).

$$V(r) = \frac{1}{4\pi\epsilon_0} \int \frac{dq}{|r - r'|}$$

Most of the steps in a problem solution were generally processing steps. A good example of a visual processing (**VP**) step is taken from the beginning of Royal's interview.

- VP** { Royal: Well, since it is infinitely long I think it is going to be constant outside or away from the rod.
- Int: Why do you think it is going to be constant away from the rod?
- Royal: Because it is infinitely long, and you are not going to be able to tell how far you are away from it at any given point. So, if you just look at the rod you are only going to see the rod infinitely long. You're not going to be able to judge how far you all are away from one end or the other.

Royal made a symmetry argument based on his mental image of the infinitely long cylinder. His statements included cues that he was processing a mental image. In particular, his statement “if you look at the rod you are only going to see the rod infinitely long” indicates that he was accessing a mental image.

Symbolic processing (**SP**) is also common. This example from the interview with Dan illustrates several instances of symbolic processing. In this case, the symbolic processing steps involve two integral evaluations and a substitution.

$$\int_0^{2\pi} \int_0^z E r dz d\phi$$

- SP** Dan : Doing that, first we are going to integrate with respect to ϕ from zero to 2π . We are going to get the integral from zero to z of $2\pi \dots$

$$\int_0^z 2\pi E r dz$$

- SP** Dan: With respect to z that equals

$$\int_0^z 2\pi E r dz = 2\pi E z r$$

- SP** Dan: And if that's my left side of my equation, I want to throw in my right side and set them equal and solve for E .

$$2\pi E z r = \frac{\rho z \pi r^2}{\epsilon_0}$$

In addition to purely visual and purely symbolic steps, subjects also engaged in processing steps that involved both visual and symbolic components. These steps were identified as visual-symbolic processing (**VSP**). The most obvious instances of visual-symbolic processing steps are those that entail translation between the visual and symbolic representations. A good example of this can be

seen in the following excerpt from John's interview. John realized that he needed to find an expression for dV in his equation for Coulomb's Law. To do this, he drew diagrams of a complete cylinder and a small piece of a cylinder to represent the dV , in essence, translating from a symbolic representation (dV) to a visual representation (the diagrams). He then identified the sub-elements of the diagram (the sides of the differential volume element) and associated these with their symbolic counterparts (dr , $rd\phi$ and dz). In this instance, John's objective was to find a symbolic expression for dV .

$$\vec{E} = \frac{1}{4\pi\epsilon_0} \iiint \frac{\rho dV(\vec{r} - \vec{r}')}{|\vec{r} - \vec{r}'|^3}$$

VSP

John: Now, I'm going to use cylindrical coordinates system. Even though I assigned xyz I'm going to go ahead and use cylindrical coordinates. And my volume element dV in cylindrical coordinates is a... Draw a cylinder... A chunk of it's going to be... And that's going to be wedged back in... This... The height will be z...err dz . This distance here...This is z . You've got r , ϕ . This is $rd\phi$ and this is dr ...this distance here. So dV in spheric...in cylindrical coordinates I'm thinking is $rdrd\phi dz$.

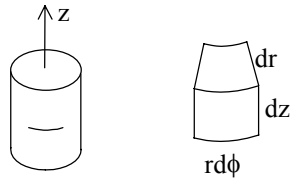

$$dV = r dr d\phi dz$$

John achieved this by translating into the visual representation, extracting information from a visual image and translating back to the symbolic representation.

Some of the steps that subjects made during the interviews were difficult to classify. This takes us back to the first example.

- VI Dean: So I have a cylinder. This goes out like this. (drawing three horizontal lines at each end to indicate that the cylinder continues on) This is going to be along the z-axis. And I want to use cylindrical coordinates, because it makes sense. This is a cylinder.
- ?P

Dean's decision to use cylindrical coordinates based on the geometry of the situation appears to be a good example of visual processing. However, it is not clear what type of processing Dean was using here. It may be that he based his decision to use cylindrical coordinates on a recognition of the symmetry of the charge distribution. On the other hand, he may have associated the fact that he has a cylinder with cylindrical coordinates based on memory or word similarity. In this case, there are no clear cues to indicate that this is either visual or symbolic processing. This ambiguity prompted us to assign a code of **?P** to indicate that he is doing some sort of processing, but that it is not clear what kind. The **?** code was assigned in a variety of cases where coding was ambiguous. This difficulty in coding can arise from a variety of causes including:

- The student's statements are confusing and or the student seems confused.
- There is some indication that the student is not thinking aloud or that he is not expressing what he is thinking as he works through the problem. This may indicate that he is skipping steps or combining steps.
- The statement does not fit neatly into our coding scheme. This may indicate that this coding scheme is not complete.

Table 6.2 contains a tabulation of the coding scheme described above.

SYMBOL	TYPE OF STEP	EXAMPLE
SI	Symbolic Initialization	A remembered or given equation, a known law (Coulomb's Law)
VI	Visual Initialization	A remembered picture or a picture drawn based on the statement of the problem.
SP	Symbolic Processing	Algebraic simplification, substitution, or equation. General symbolic manipulation.
VP	Visual Processing	Simplification using symmetry, generation of a diagram/picture or elements there of, rotation or translation of a diagram. General visual manipulation.
VSP	Visual - Symbolic Processing	Includes statements that clearly involve visual and symbolic processes that are intertwined. These steps include translations between symbolic and visual representations as well as processing or manipulation of visual and symbolic elements.
?	Unclear or Undecided Coding	It is not clear what code to apply. This could result from a variety of causes.

Table 6.2 - Tabulation of coding scheme

6.4.3 Visual Problem Solving Strategies

In solving the proposed problem, subjects routinely broke the problem down into smaller sub-problems. These sub-problems were then attacked with a combination of visual and symbolic problem solving strategies. In this section, we will describe two prevalent visual strategies and explore the interplay of visual and symbolic steps in the context of these strategies.

6.4.4 Visual Reconstruction

All of the subjects used visualization as a memory tool. In each case, pictures were used to help recall the important elements of a problem solution. In

many instances, subjects used a combination of memory and reasoning to reconstruct images and equations they needed.

Good examples of this occurred when subjects tried to find expressions for the differential volume or area elements (dV or $d\bar{a}$). In these instances, subjects often used simple diagrams to help them find expressions that reflect the geometry of the problem.

In this example, John drew a diagram of a differential volume element to help him find the expression for dV in his equation for Coulomb's Law. In this case, he was clearly reconstructing this image. First, he drew a cylinder. Then, based on that drawing, he drew a "chunk" of the cylinder (a differential volume element corresponding to dV). He then identified and labeled the sides of this "chunk" and multiplied them together to get an expression for dV .

VSP John: And my volume element dV in cylindrical coordinates is a... Draw a cylinder... A chunk of it's going to be... And that's going to be wedged back in... This... The height will be z ...err dz . This distance here... This is z . You've got r , ϕ . This is $r d\phi$ and this is dr ...this distance here. So dV in spheric...in cylindrical coordinates. I'm thinking is $r dr d\phi dz$.

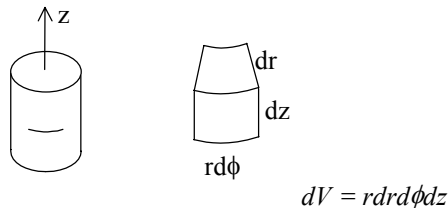

In this instance, Royal remembered the equation for da , but used a diagram to check his equation.

VP Royal: da for this rod is going to be in cylindrical coordinates $r d\phi dx$ cause it's um... Where this is ϕ this is r and this is dx .

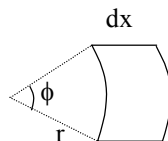

Another good example of visual reconstruction was when Royal used a diagram to recover parts of Coulomb's Law. Here, Royal recalled some of the equation, but also used the diagram to identify some of the essential elements.

- SP** Royal: So we're going to have $E=1/(4\pi\epsilon_0)$ times some big ugly integral
VP that's going to have $\rho d\tau$ over... then we will hang out right here and look at
VSP a point right there. This is r and this is r' and we know that the electric field
 that you are going to see at this point from this whole thing is going to be
 dependent on this distance here which will be r minus r' (drawing the arrow
 from the r vector to the r' vector).

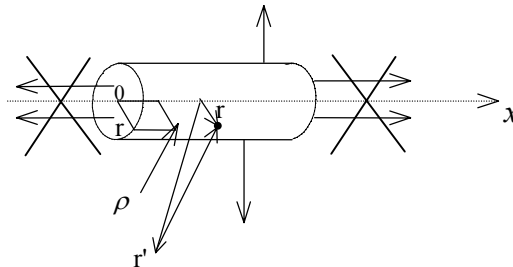

$$E = \frac{1}{4\pi\epsilon_0} \int_0^r \frac{\rho d\tau}{|r - r'|}$$

This is Royal's second attempt to construct this equation. In the first instance, he had not defined the \vec{r} and \vec{r}' vectors. Instead he had loosely defined the denominator in Coulomb's Law with the statement, "the distance away can be...I don't know... k in the k direction." While the details of this equation are still not correct, he has used his drawing to define and identify the important displacement in the problem.

Visual reconstruction as described here can involve symbolic as well as visual processing. This strategy was often combined with pure symbolic processing to find an expression for one of the pieces in a central equation. In this example, Dean used a combination of visual and symbolic steps effectively to develop an expression for dq . He began by writing a general equation he remembered for the potential due to a charge distribution (1 SI). He then found a value for dq using a simple two-dimensional diagram (2 VSP & 3 VSP). He then realized that this equation was not correct and drew a three-dimensional diagram to

help him construct the correct equation (4 VP). He then identified the differential lengths in this diagram and multiplied them together (5 VSP & 6 VSP). Finally, he substituted this expression for the differential volume into his equation for dq (7 SP).

Dean: Okay, let's see. It's infinite, so the first thing I want to do is find the potential. And that is V at some r is equal to ... (says equations as he writes).

1 SI

$$V(r) = \frac{1}{4\pi\epsilon_0} \int \frac{dq}{|r-r'|}$$

Dean: Okay, so then dq is going to be a little part of this cylinder, which is going to be a volume. The volume of a ... Oh, wait that's right... Well, I'll do that first anyway.

2 VSP

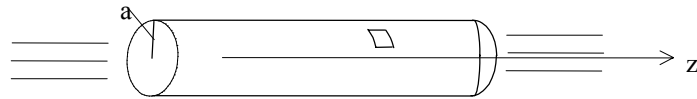

3 VSP

Dean: So dq ... a little piece of this cylinder so it's going to be dr wide and it's going to be dz long and...

$$dq = drdz$$

Dean: So how can I write that? I don't know how... I'm trying to make a solid...

4 VP

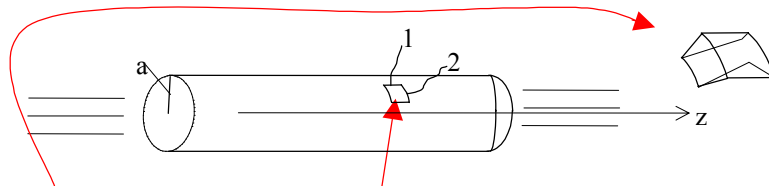

5 VSP

Dean: So this is going to correspond to this. This is 1, this is 2 and the width of it going in radially will be 3

Dean: So 3 is going to be dr . The outside is going to be, so that's 2, is going to be $rd\phi$. And 1 is going to be the top which is dz because it's just along the axis.

6 VSP

$$1 = dz$$

$$2 = rd\phi$$

$$3 = dr$$

Dean: So, to find the volume, just multiply all those out. So it's going to be...
 $dV \dots dV$ times the constant. You said $\rho \dots$ a constant charge of ρ .

7 SP

$$dq = dV\rho$$

$$dq = (r'dr'd\phi'dz')\rho$$

In all of these cases, the resulting information is something that could have been remembered or looked up. The students, however, chose to use a combination of memory and reasoning to reconstruct this information. This is in sharp contrast to the “plug and chug” problem-solving behavior typical of introductory courses. These students exhibited behavior that is common to more advanced problem solvers. That is, they derived or constructed pieces of their solution as opposed to memorizing each of the parts. In these cases, visual processing seems to be an integral part of this process.

6.4.5 Visual Simplification

Another common visual strategy was to try to simplify equations or quantities with the aid of pictures. The use of images to identify symmetry was very common in these problem solutions. In this example, Royal made symmetry arguments to support his claim that the electric field was constant outside the cylinder. He used a mental image of the rod to explore the consequences of the rod being infinitely long. He made good arguments to suggest that the electric field was independent of z , but overgeneralized and claimed that the field was constant.

VP Royal: Well, since it is infinitely long I think it is going to be constant outside or away from the rod.

Int: Why do you think it is going to be constant away from the rod?

VP Royal: Because it is infinitely long, and you are not going to be able to tell how far you are away from it at any given point. So, if you just look at the rod you are only going to see the rod infinitely long. You're not going to be able to judge how far you all are away from one end or the other.

In another example, Dean made careful arguments that the field did not depend on z or ϕ . Dean used explicit references to points in a picture he had drawn to make his statements of symmetry clear. Early in his arguments, he claimed that the electric field was constant, but by the end of this sequence, he began to question this assertion.

VP Dean: So we are solving for this and since this is infinite, the electric field outside of here (indicating in the region below the cylinders) is ...is constant. It's felt the same here as it is here (drawing two dots on the board), because...because they don't know the relation with respect to z because this is an infinite in the z direction.

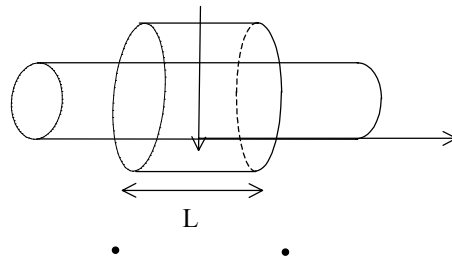

VP Dean: And this is going to be radially symmetric like this. (moving his arm around in a circle with an axis parallel to the cylinders on the board.) So as long as this is the same distance as here, they are going to feel the same as them so you can do that all the way around.

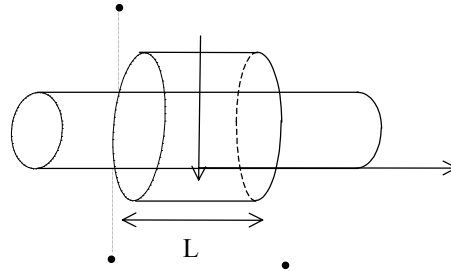

VP Dean: And like we said r ... that represents r away from the z equals zero. That's going to be a constant (writes $r=\text{constant}$) Okay, is that what I'm trying to say. (Erases $r=\text{constant}$). Anyway, you know what I mean. I'm not going to ...

In both of these cases, the subjects began with strong statements about the behavior of the electric field. They then tried to justify these statements with symmetry arguments. This was a common strategy in these interviews. Subjects often used intuition to describe the electric field. They then used visual symmetry arguments to justify these intuition-based assertions. In many cases, these attempts to justify their intuitions were unsuccessful, often because these intuitions were incorrect. Some of the subjects used this information to revise their description of the electric field while others retained their intuitions in spite of information that suggested they were flawed.

In some instances, subjects applied the results of visual simplification arguments from earlier in the interview to help them with other parts of the problem. A good example of this comes from Dean's interview. Here, Dean was trying to find the flux through the endcaps of his Gaussian surface. As this excerpt begins, he had just found that the direction for the differential area element of the endcaps was along the \hat{z} direction

SP Dean: So we don't have to worry about the z component...err...the r component or the ϕ component. We just want to worry about the z component because we are going to be dotting it so the other parts are just going to be falling out anyway. ...The z component of the electric field is going to be...

VSP Dean: My thought right now is that it's zero on those. But I'm trying to figure out why. Oh, because the electric field only points out radially. And because of that, this (indicating the $E \cdot dA$) is going to be zero, because there is only a z component of the area. This is not going to be...not going to have a z component because the electric field only points out radially, because of the symmetry argument right here (pointing to the two small arrows at the top of the Gaussian surface diagram).

Dean indicated the drawing associated with a symmetry argument he made earlier. In this argument, he justified his statement that the electric field pointed radially outward.

Dean: I know this, so E ...E's going to be constant. So $\vec{E} = E\hat{r}$

Int: How do you know that?

VP Dean: Because the electric field is pointing radially outward from the cylinder...the field.

Int: How do you know that?

VP Dean: Because of this...because this is infinite. So, whatever...oh, because of that symmetry argument I was using. When...there's a piece over here and there's a piece over here. So if you have a charge here, it's going to feel a vector pointing this way and a vector pointing that way

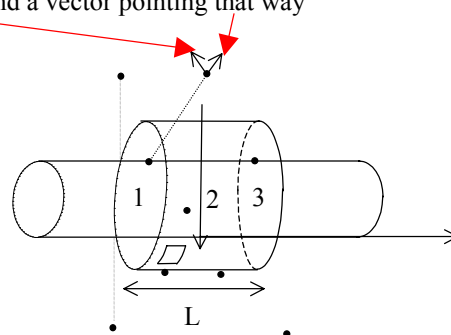

VP Dean: and these two components are going to...the horizontal components...the z components are going to cancel out (puts bottoms of fists together with thumbs pointing out) and you are only going to feel a radial force or a radial field vector. Okay.

In other instances, subjects used visual simplification to find the properties of the electric field, but then did not use the results of this simplification to help them solve the main problem. This was particularly common with Tom. Tom obtained useful information about the electric field from visual arguments but never utilized this information. Here is an example where Tom explored the behavior of the electric field far away from the charged cylinder. Tom began by acknowledging that he wanted to use symmetry to simplify the problem. He made a variety of true statements about the nature of the electric field but then did not use them to perform the simplification he suggested.

VP

Tom : I know that a lot of what I'm trying to remember, I'm not going to need. I'm going to be able to throw some of it away. I'll try to throw a lot of it away with symmetry arguments. With the density. I'm thinking hey, if I back way off of this thing...this cylinder, it's going to look just like a wire or a line if I get far enough away. It's only when I get really close that the fact that it has a diameter a is going to make a difference. So I'm expecting it to look like...ummm...I'm expecting it to look like...like a wire. It's...So I'm thinking it's only going to depend on ... r ...call it r minus a . If it's infinitely long, z right, then wherever I am, wherever my z component is doesn't matter, because wherever I'm at in z doesn't matter. (waving hand up and down along the z axis). So, that z symmetry drops out. The θ is the same story. Whatever my angle is around...

6.4.6 Summary of Analysis

The most striking result of these interviews is the degree to which student use visual and non-visual methods in close conjunction. Admittedly, the interview problem was chosen to provide students with an opportunity to use visual methods. Still, nearly every student in the sample utilized a complex combination of visual and non-visual steps and strategies. In many cases, it was difficult to identify steps as visual or symbolic, since the subjects were using visual and symbolic representations in such close connection. This result stands out against much of the

existing research, which has attempted to study students' ability to visualize in isolation from non-visual processing.

A second result of this research is the introduction of a new model that promises to help us explore the interaction between visual and non-visual modes of thinking in physics problem solving. In the preceding sections, we have illustrated a new method for examining student use of visual and symbolic steps in problem solving. Based on the V/A model (Zazkis, Dubinsky and Dautermann, 1996), this method has several new features. First, the definitions and elements used here are readily associated with observables from the interviews. The visual and symbolic steps defined in Section 6.4.2 are generally easy to identify in the interview transcripts. We have also accounted for steps involving visual and symbolic processing as well as steps that are difficult to categorize.

Secondly, we explore the relationship between visual and symbolic steps as opposed to acts of visualization and analysis. Analysis takes on a different role in the method described here. Each visual or symbolic step contains within it some acts of analysis in the sense described by Zazkis, Dubinsky and Dautermann. In this study, we explicitly avoid trying to identify analysis independently of a visual or symbolic representation. At best identifying purely analytical steps is a subjective endeavor; at worst, it is impossible.

As it stands, this analysis presents a useful model for describing how upper-division physics students use visualization in problem solving. We have provided examples in which visual and symbolic steps are used in combination as part of a complex problem solution. However, we have yet to synthesize a description of how the steps described in Section 6.4.2 are used together in problem solving. In other words, we have defined the elements of our model but still need to explore how these elements work together in students' problem solving. Our intent upon the completion of this analysis was to explore the interaction of the model elements described here in the context of another set of interviews. However, as we describe in Section 7.4, our focus shifted after a preliminary analysis of the final interviews.

Chapter 7 Final Interviews

In the fall term of 2000, we conducted a set of think-aloud interviews in which students were asked to solve a problem involving the calculation of electric flux. The goal of these interviews was to gain an understanding of student problem solving at this level and, in particular, their use of visualization in problem solving. This chapter describes the administration of these interviews as well as their analysis.

7.1 Sample

Fifteen volunteers from a class of 19 physics and engineering physics students were interviewed. This sample consisted of 12 male and 3 female students. The female/male ratio of 20% was typical of undergraduate physics classes at Oregon State University, but considerably higher than the national average of around 12% (Ivie & Stowe, 2000).

The class of 20 students was administered the PSVT (Guay, 1976) to determine the general spatial ability of each subject. A tabulation of student scores on the PSVT and incoming math and physics grade-point average (GPA) is listed for each student in Table 7.1. The average PSVT scores for the sample (N=15) was 32.3 compared to a score of 31.9 for the entire class (N=20). The average incoming math and physics GPA for the sample was 3.02 compared to 3.17 for the entire class. The similarity of these statistics indicates that the voluntary sample represents the entire class quite well, as well it should since the sample constitutes over three quarters of the population.

A regression analysis measuring the relationship between PSVT score and incoming GPA revealed that there was no significant correlation ($R^2 = 0.033$,

$F=0.45$, $\alpha=0.52$) between these variables. This data agrees very closely with the data from Section 4.5.1.

Pseudonym	PSVT (0-36)	Incoming GPA (0-4)
Enkidu	34	3.27
Tortuga	34	2.17
Sirius	28	1.99
Blue	34	3.61
Yellow	36	3.61
Shedder	28	2.42
Bravo	30	4.00
Jerry	31	2.49
Chameleon	35	3.40
Parsec	35	3.47
Penguin	31	2.53
Turtle	29	3.81
Q	34	2.62
Garfield	35	2.36
Scooby	31	3.58
Class Average	32.3	3.02

Table 7.1 - Tabulation of students' PSVT scores and Incoming Math and Physics GPA

7.2 Data Collection and Interview Protocol

Subjects participated in think-aloud interviews in which they were asked to solve an electrostatic flux problem. Each of the interviews was administered by the author and lasted between 45 minutes and one hour. Subjects were not allowed access to reference materials including books and notes except were noted. The

interviews were videotaped with the permission of the subjects and later transcribed. Transcriptions were carried out by the author and included all drawings, equations, etc... as well as notes on hand gestures and references to items written on the board. A timeline for the interview protocol is shown in Figure 7.1.

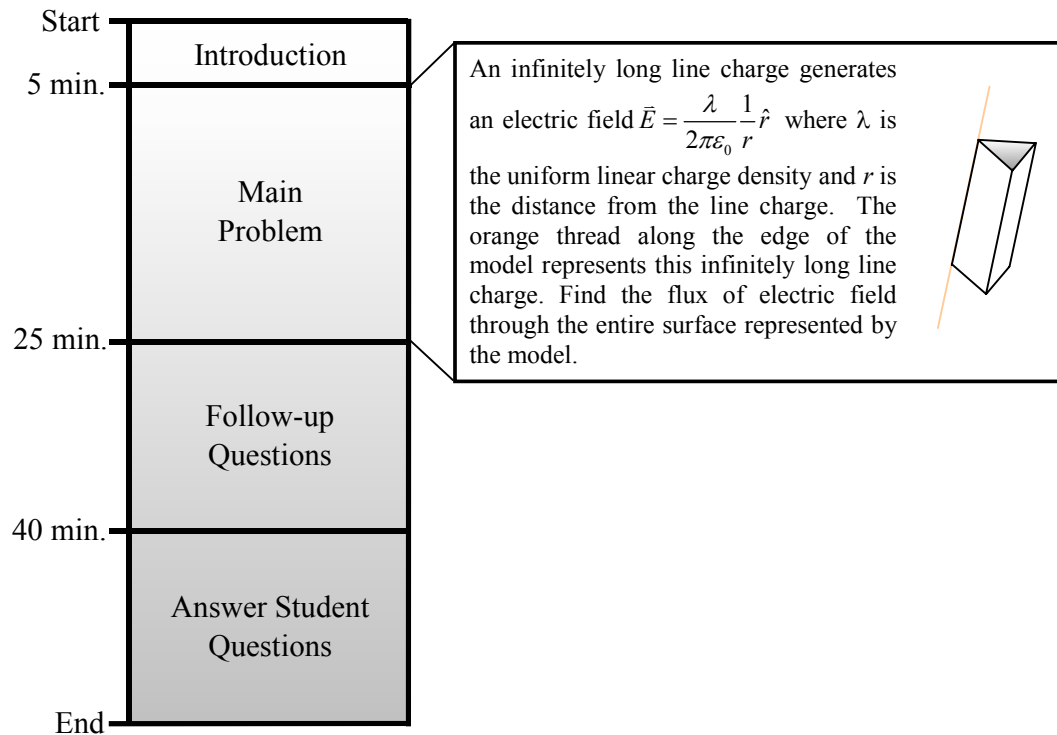

Figure 7.1 - Interview timeline and problem statement.

As in the preliminary study, the interviewer began by explaining the think-aloud format of the interviews. The interviewer explained that the questions he would ask were intended to elicit information about the subjects thinking process and should not be taken as guiding questions. Subjects were asked to talk through their thinking process as they worked and were encouraged to use the chalkboard. The interviewer encouraged subjects to ask any questions that came to mind, but

warned them that he would not answer all questions. Subjects chose pseudonyms that would be used to identify them once the interviews had been transcribed.

Once the introductions had been completed, the interviewer asked the subject to work through the following problem. (Note: Several solutions to this problem can be found in the appendix.)

An infinitely long line charge generates an electric field

$$\vec{E} = \frac{\lambda}{2\pi\epsilon_0} \frac{1}{r} \hat{r}$$

where λ is the uniform linear charge density and r is the distance from the line charge. The orange thread along the edge represents this infinitely long line charge. Find the flux of electric field through the entire surface represented by the model.

The interviewer presented the subject with a physical model of the system as shown in Figure 7.1. The model consisted of an 8.5" x 11" sheet of white paper folded and taped into the shape of an equilateral triangular tube. Along one edge of the tube was taped an orange thread. The model was suspended between the ceiling and floor by this thread. The subject was then given 20 minutes to work through the problem. During this time the interviewer encouraged the subjects to talk about their thinking process and asked them to clarify any unclear statements they made.

At the end of 20 minutes, the interviewer began to ask a series of follow-up questions designed to elicit more information about the subject's thinking process with respect to this problem. These questions were as follows.

1. Explain flux to me
2. Given a surface in the shape of a hexagonal tube of length l and side a centered on an infinitely long line charge like the one you were using before, what is the flux of electric field through this surface.
3. How do you generally approach this type of problem?
4. Is there anything that you would like to share about the Paradigms?

Subjects were allowed to return to their solution of the main problem at any time during the administration of the follow-up questions. In some instances, the follow-up questions were asked and answered in an uninterrupted sequence. In others, the subjects returned to the main problem between follow-up questions. The final follow-up question was asked to collect data for the evaluation of the Paradigms in Physics program. Anonymous transcripts of student responses to this question were submitted to the Paradigms in Physics evaluation team.

Upon completion of the interview, subjects were encouraged to ask questions about the problems. These questions were answered and subjects were given the option of discussing the interview questions with the interviewer off camera. The length of time for each interview varied between 45 minutes and one hour depending upon the speed with which subjects answered each question as well as the amount of time spent on student questions at the end of the interview.

Significant deviations from this protocol occurred in two of the interviews. Very early on in his interview, Blue became stumped and gave up. The interviewer responded to this by asking the subject the first of the follow-up questions very early in the interview. Following this question, the subject returned to the main problem. Subsequent follow-up questions were asked in accord with the schedule outlined above.

Shedder's interview was affected by more substantial irregularities. Due to an equipment malfunction, the first 15 minutes of the interview was not videotaped. This was recognized during the interview and the malfunction corrected. At this point, the interviewer asked the subject to review what she had done during the first 15 minutes of the interview. We considered dropping this interview from the study, however, since the subject was one of only three women included in the study the data from this interview was retained. Conclusions drawn from this interview should be examined with extra scrutiny since the interview environment was more reflective than the other interviews in this study.

7.3 Choice of the Interview Problem

Our goal in selecting the interview problem was to choose a problem that would encourage students to demonstrate the use imagery and equations together while solving problems. We chose a problem from electrostatics because it was reasonably fresh in students' minds. The particular problem used in the interviews described here was chosen based on a number of other important criteria. First, it was essential that the problem allow students' many opportunities to use equations and imagery together. Second, it was important that the problem be based on recent course material but not be too closely related. We wanted students to be able to make significant progress on the problem, but we did not want the problem to be so similar to ones they had solved recently that they could remember large parts of the problem solution.

In addition, there were several logistical requirements for the problem. First, it was important that the entire interview last less than one hour. Taking into account time for introductions, explanations and follow-up questions, this left roughly 30 minutes for the main problem. The problem used in the preliminary interviews was too long and too complicated to analyze easily. We chose what we thought would be a shorter problem for these interviews. This shorter format also allowed more students to be interviewed since the transcription and analysis time for a single interview was decreased.

The problem we chose is described in Section 7.2 and several solutions to this problem can be found in the appendix. In developing this problem we considered several problems and conducted brief interviews to determine if each problem had the potential to meet the above criteria. These interviews showed that students used a rich variety of imagery together with equations in solving this problem. We tested this problem in two formats. One that involved a purely verbal explanation and one that involved the model described in Section 7.2. We found that the students experienced difficulties understanding the verbal description of the model and we were unable to concoct a satisfactory verbal description.

We chose electric flux as the topic for this problem because understanding flux problems requires a combination of verbal and visual problem solving skills. A successful solution to the problem described above can be achieved with the use of primarily verbal or visual strategies; however, a complete understanding of the problem utilizes a complex intertwining of the two.

This problem allowed several different avenues of solution. Students had the opportunity to choose either rectangular or cylindrical coordinates, but in either case, would have to translate some of the elements of the problem from one coordinate system to the other. In addition, subjects could simplify the problem using Gauss's Law. Each of these possible solutions is described in the context of student solutions below.

7.4 Results/Analysis

We began the analysis of this set of interviews by directly following up the analysis of the Chapter 6. We coded the transcripts searching for visual strategies and identifying visual and symbolic steps. Two results emerged from this analysis. First, the most common strategies we identified were construction, as defined above, and checking, a new strategy described in Section 7.4.2. In addition, we noted that these two strategies were often found in conjunction. Second, we found that most of the strategies we identified contained a mix of visual, symbolic and verbal steps. This supported one of the most significant results of the research in Chapter 6, that student's use of visual representations in problem solving is intertwined with their use of non-visual representations.

Based on these conclusions we adjusted the direction of our analysis. Section 7.4.1 describes the subjects' overall performance in solving the interview problems. In Section 7.4.2, we describe the pattern of construction and checking that we observed and we outline a simple model for understanding this pattern. Finally, in

Section 7.4.3, we explore the subjects' models of flux. In particular, we describe the typical model students have and the difficulties that some students experience.

7.4.1 Overall Performance

Subjects' performance on the main flux problem varied from one student who solved the problem in a complete and thorough manner to a few students who were only able to make small amounts of progress toward a solution. Table 7.2 shows the subject groupings according to overall performance on the main flux problem. Subjects in the high performance group produced a solution that was correct to within simple algebraic errors. Both of the subjects in the high performance group utilized some form of Gauss's Law to simplify the problem.

Each of the subjects in the middle performance group was able to recall or construct a correct equation for flux. In addition, they were able to use this equation in a correct and productive manner, but were unable to produce a correct solution. Each of the subjects in this group either did not produce a final solution in the allowed time or expressed doubt about the correctness of their solution. In general, individuals in the medium performance group were unable to solve the problem due to difficulties translating between cylindrical and rectangular coordinates.

Subjects in the low performance group made only minimal progress toward a correct solution of the problem. Three of the subjects, Scooby, Sirius and Blue were unable to recall or reconstruct a correct equation for flux. Garfield was able to write the correct equation for flux, but thought that it was incorrect and promptly erased it. Jerry recalled and used the proper equation for flux, but because his model of flux was so flawed, he was unable to make significant progress toward a solution.

Name	Performance
Jerry	Low: Did not use the correct flux equation to make significant progress
Sirius	
Scooby	
Blue	
Garfield	
Yellow	Medium: Used the correct flux equation to make significant progress but were not able to obtain a solution. Most had problems with translation from rectangular to cylindrical coordinates.
Parsec	
Turtle	
Tortuga	
Chameleon	
Enkidu	
Bravo	
Penguin	
Shedder	High: Solution correct to within algebra errors. Used Gauss' Law.
Q	

Table 7.2 - Grouping of Subjects by Performance

In addition to performance groupings, we found that most of the students fell into natural groups based on their method of solution and on the particular difficulties they encountered. A tabulation of these groupings is presented in Table 7.3. Three of the subjects in the low performance group, Jerry, Sirius and Scooby, were deemed the Poor Flux Model group, because they had poor or incomplete models of flux. These were the only three students in the sample that did not recognize that the flux through the sides of the surface adjacent to the line charge would be zero. Students models of flux will be discussed more in Section 7.4.3

The other two students in the low performance group, Blue and Garfield, had more complete models of flux but made very few quantitative statements. They were called the Qualitative group because their entire interviews consisted of qualitative and visual arguments. While this qualitative approach helped them to

gain some understanding of the problem, they did not make significant progress toward a solution.

Five of the subjects in the middle performance group, Parsec, Turtle, Tortuga, Chameleon and Enkidu, were grouped together because each of them experienced difficulty defining the differential area element, $d\vec{a}$, for a flat side in cylindrical coordinates. In general, these subjects had expected to write down some form of $d\vec{a} = rd\phi dz\hat{r}$ in analogy to solutions they had seen before for electrostatics problems in cylindrical coordinates. This group was deemed the Difficulties with $d\vec{a}$ group.

Name	Solution Characteristics
Jerry	Poor Flux Models - Didn't recognize that the sides adjacent to the charge had no flux though them. Achieved very little progress toward solution.
Sirius	
Scooby	
Blue	Qualitative - Few Quantitative statements. Made lots of true statements but drew few conclusions and made few useful connections.
Garfield	
Yellow	Chose to use rectangular coordinates. Got stuck on integral.
Parsec	Difficulties with $d\vec{a}$ - Had difficulty writing down $d\vec{a} = dx dz$. Expected to write $rd\phi dx$ and got stumped. Confused because the surface and electric field are most easily represented in different coordinate systems.
Turtle	
Tortuga	
Chameleon	
Enkidu	
Bravo	Quantitative - Used few qualitative arguments. Didn't like and had difficulty with using images.
Penguin	
Shedder	Used Gauss' Law to argue that the flux through the given surface should be one sixth.
Q	Used Gauss' Law to justify equating the flat side to an arced surface with constant radius.

Table 7.3 - Grouping of subjects by solution characteristics.

Bravo and Penguin, also middle performers, were grouped together because they both approached the problem in a very quantitative manner. Both expressed some discomfort or dislike of using pictures and noted that pictures often confused them. While both of these subjects drew many pictures, they tended to draw the same picture several times with only minor changes. In most cases, these pictures were geometric representations they used to convert between rectangular and cylindrical coordinates. In addition, Bravo and Penguin each had difficulty extracting information from their pictures. Bravo and Penguin were regarded as the Quantitative group.

The other three subjects did not fall neatly into any group. Yellow was the only subject to try to solve the problem in rectangular coordinates. In general, his solution proceeded along a productive path. However, his final integral was impossible to evaluate because of a mistake he had made translating between cylindrical and rectangular coordinates.

Both Shedder and Q produced a correct result using Gauss's Law. However, their methods of solution were somewhat different. Q and Shedder began by equating the flat side opposite the line charge with an arced surface of constant radius. Q justified this step using Gauss's Law and proceeded to solve the simpler arc problem in cylindrical coordinates. Shedder, on the other hand, abandoned this idea when she was unable to justify it. After questioning the interviewer about the exact position of the line charge, she argued that the flux through the triangular tube would be one sixth of the total flux coming from the line charge over the length of the triangular tube. She then used Gauss Law to calculate the flux.

7.4.2 A Model of Construction and Checking

In the pilot study, one of the problem-solving strategies identified was visual construction. During the analysis of the final interviews, we looked closely at students' use of construction as a strategy. We found that instances where students

used construction were often followed by checking events. In these checking events, subjects tested the conclusions drawn in construction against other information they had. A cyclic pattern of construction and checking was observed in most students' problem solving behavior. This pattern served as the basis for a model that has been useful in analyzing the similarities and differences in subjects' problem solving behaviors. Here, we describe this model and provide several examples of its variations throughout these interviews.

This model describes a process in which subjects draw together several pieces of input information to construct a conclusion. This conclusion is then checked. If the check fails, more information is brought in and the conclusion is refined. In the ideal case, this process continues until the conclusion passes the checking process. Once a conclusion has passed the checking process, it is passed on to be used as an input for drawing later conclusions. The result is a cyclic pattern in which early conclusions are used as the basis for later conclusions until a final solution is achieved.

For simplicity in analysis, we relate excerpts from students' interviews with this model in a diagrammatic format. Figure 7.2 shows a prototypical diagram. Here, several pieces of input information are used to draw a conclusion. This conclusion fails a check and a revised conclusion is constructed from the original conclusion, results of the check and some new information. This revised conclusion then passes a final check.

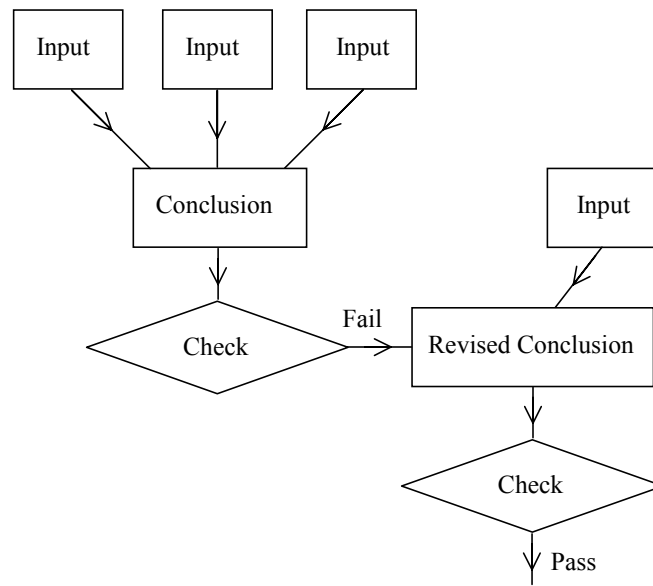
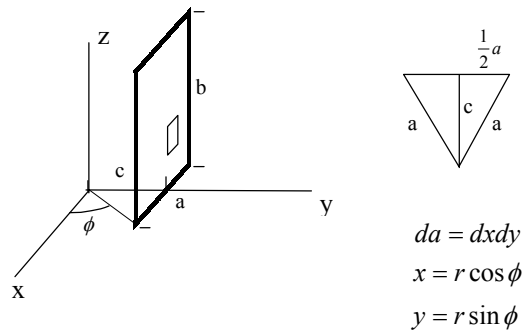

Figure 7.2 - Diagrammatic representation of the conclusions/check model

In order to get a better understanding of how these diagrams are related to student problem-solving behavior, we can look at an excerpt from Enkidu's interview. Enkidu is trying to translate his *da* to cylindrical coordinates. In this excerpt, he constructs equations relating the Cartesian coordinates x and y with the cylindrical coordinates r and ϕ . Figure 7.3 shows a diagrammatic representation of this excerpt in the context of our model. Enkidu uses three pieces of explicitly mentioned input (Statements [1], [2] and [3]) in addition to some unstated (indicated with a dashed line) recall input to construct his equations for x and y in cylindrical coordinates (Statements [4] & [5]). He then checks this conclusion against a remembered image of a right triangle used for calculating $\sin \phi$ and $\cos \phi$ (Statement [6]). This check passes and he proceeds to use these equations to construct dx and dy .

Enkidu: Okay, if this is in cylindrical [1], my $da = dx dy$ [2] in cylindrical coordinates is equal to... There's like a $\cos \phi$ [3] and a something. I think it's $r \cos \phi$ that's what x is [4]... maybe. And $y = r \sin \phi$ [5] where

this is cylindrical and this is ϕ (drawing and indication of the angle ϕ from the x axis) I should look at it and make sure that is right.



Enkidu: Is this right (draws a triangle around the ϕ in the drawing to check that he has defined correctly) Cosine of the angle is x, sine of the angle is y. And r changes its length... multiplies it... So yeah [6]

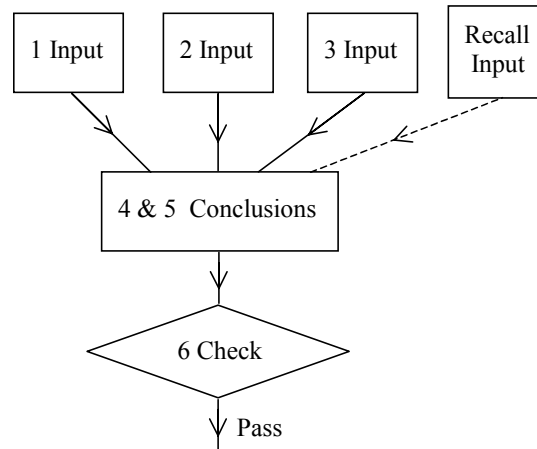

Figure 7.3 - Diagrammatic representation of Enkidu's conclusion and checking process.

In the context of this model, inputs are pieces of knowledge students bring to the part of the problem they are solving. Students obtain these pieces of knowledge from a variety of sources including: recall, observation, construction, guessing, reference sources and the problem statement. Students recall typically items like

facts, equations and images. However, they also recall more complex structures like concepts and solution methods. In addition, students' memory is often incomplete. In some cases students may only remember part of an equation or a single property of a complex concept. Students make observations of the physical world, but also make more complex observations. For example, noting the behavior of equations or observing the properties of a drawn image. In some instances, students supplement recalled information with guessing. In some cases, they automatically fill in missing pieces without realizing it. In other instances, they are aware that their recall is incomplete and make a conscious guess. At this educational level, many of the subjects rely heavily on reference materials. While no references were provided in this interview, it was common for subjects to ask if they could reference notes or a book.

In this study, we refer to information resulting from the construction process described above as conclusions. For the purposes of this model, conclusions were defined as information constructed from two or more pieces of input. However, most of the conclusions we identified synthesized several pieces of information. Conclusions served as another form of input information for most of the subjects.

In the ideal case, in which they have perfect recall and flawless reasoning, subjects would build problem solutions by constructing a chain of these conclusions each building upon previous conclusions until the final solution is reached. In reality, both recall and reasoning have faults. To deal with these faults, subjects employ a variety of checking procedures to test the validity of conclusions. In some cases, it is a simple review to identify obvious errors. In others, it involves comparison to other known information. In still others, it may involve complex reasoning to test the plausibility of the conclusion

In the example from Enkidu's interview above, he explicitly states three pieces of input he uses to construct the equations for x and y in cylindrical coordinates. He mentions cylindrical coordinates and the differential area element, $da = dx dy$, he is trying to convert. Each of these is a conclusion resulting from previous construction. He also utilizes a partially recalled equation, "There's like a

$\cos \phi$ and something.” The resulting conclusions are then checked against the recalled image of a right triangle from introductory trigonometry.

7.4.2.1 Complex Structures

The thought structures students used to draw conclusions in these interviews were not all as simple as the example given above. Some of the structures are quite complex, involving several conclusions or repeated checking. The following example from the interview with Q illustrates a more complex structure with multiple checking and several conclusions. In this excerpt, Q constructed and refined an equation for flux. In statement 2, he postulated a simple equation for flux from memory. He then realized for himself that it is incomplete (Statement [3]) and refined the equation utilizing several other recalled properties of flux (Statements [4], [5], [6] and [7]). Next, Q refined the equation again, adding information about the direction of the differential area element (Statements [8], [9] and [10]). A diagrammatic representation of this excerpt is given in Figure 7.4

Q: And then I'm going to integrate the E-field. [1] Flux equals ($\phi = Ea$) [2] and so. Is that the right equation for flux? [3] You can't answer that.

Interviewer: I can't really answer that. There are a lot of equations for flux.

Q: For the flux in the electric charge...err using the electric field is just the electric field going through an area...or the total electric field through an area. [4]

Q: Oh, e dot and then the normal is what it is. [5] Oh, yeah and you would integrate it. [6] ($\phi = \int E \cdot d\vec{a}$) [7] Where $d\vec{a}$ equals... da [8] and then the normal which is oops r . [9] (replacing the \hat{n} with \hat{r} to get $d\vec{a} = da\hat{r}$). [10]

Q: What I just did was take the area and say that the flux was the field going through it in the perpendicular direction. (drawing an arrow on the side of the triangle opposite the charge) [11]

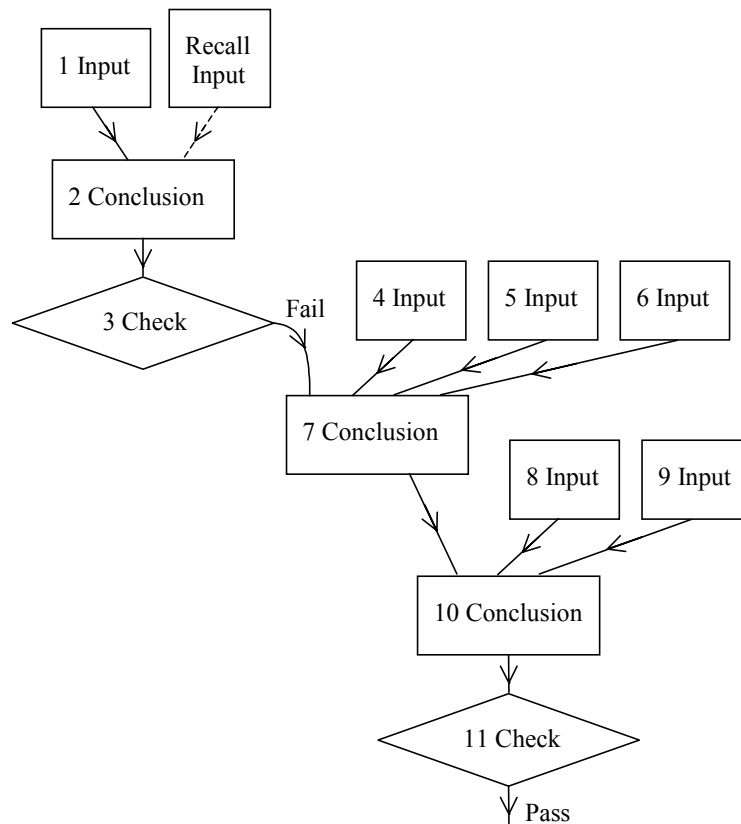
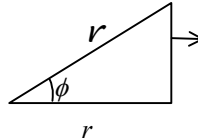

Figure 7.4 - Diagrammatic representation of Q's construction of the flux equation.

Most of the conclusions-checking structures identified in these interviews were similar to those described above in that several pieces of information were synthesized to draw a conclusion that was then checked for validity. In these cases, most of the input information is used to draw or refine a conclusion.

Interestingly, we found that in some instances, the bulk of the input information was applied at the checking stage. In such cases, the student would draw a conclusion based on only a small amount of input information. Then upon checking this conclusion the student would bring in several more pieces of information supporting and enriching the conclusion. The following excerpt from Parsec's interview illustrates this behavior.

In this example, Parsec constructed an equation for flux. Comparing this excerpt to Q's construction of the flux equation above, it is clear that Parsec generated the correct flux equation very quickly. Whereas Q refined his construction from a simpler equation, Parsec produced the correct equation with no explicit refining. In fact, Parsec noted that he was recalling the equation in Statement [3]. In this case, the bulk of information about the flux equation was brought in during the checking procedure (Statements [5], [6], [7] and [8]). The checking process served as a constructive justification, both confirming and expanding the original conclusion. In the checking step, Parsec established connections between the equation and his qualitative/geometric understanding of the problem.

Parsec: The flux being the amount of the vector going through a surface
[1] ...

Parsec: So, I'm thinking about this thing (mumbling)... (drawing a 3-D picture of the triangular tube and writing the equation for flux) [2]

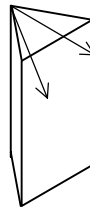

$$\text{Flux} = \int E \cdot da$$

Interviewer: What are you writing?

Parsec: The flux integral.

Interviewer: Where did the equation come from? Are you just remembering it?

Parsec: Yeah, I'm trying to remember it. [3] I think that is correct, because it is the electric field. [4] And we are finding the flux of the electric field which is the amount of electric field through the surface. [5] It's only the field that travels through the surface [6]...so the perpendicular field. [7] so the dot product (pointing to the dot product in the flux equation) would give that to you [8].

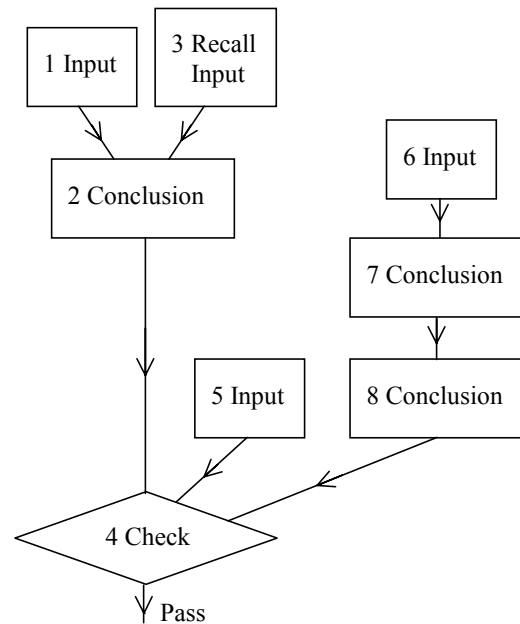

Figure 7.5 - Diagrammatic representation of Parsec's construction of the flux equation.

The excerpt from Q's interview clearly shows an example of the student constructing a quantitative representation from a qualitative representation. In contrast, Parsec clearly used his equation as a basis for recalling/constructing his qualitative understanding of the system. Observing these contrasting methods for construction/recall brings to mind several interesting questions. Which of these methods is most common? Are there any patterns in expert/novice use of these methods? Do particular subjects prefer one method or another? If so, does this

preference change as the subject's problem-solving abilities improve? While these questions are beyond the scope of the present study, we intend to address them in the future.

7.4.2.2 *Difficult or Trivial?*

Using this model as a framework, an interesting pattern was observed. We noticed that students' often engaged in elaborate thinking processes in order to arrive at conclusions that seem trivial to the experienced problem solver. The following excerpt from Turtle's interview illustrates this point.

Turtle: I'm thinking if I had a line charge and then at some point that's the e-field. [1] I'm concerned about the shape of what the flux is going through. [2] I am trying to decide what's the best way to go about this.

Interviewer: Why are you concerned? What is your concern?

Turtle: It is an unusual shape. Because well the direction. [3] Do you want me to talk as I go through this or just solve...

Interviewer: Yes, talk to me and tell me what you are thinking. And I will remind you to do that.

Turtle: Well, if the e-field is directly...is radially outward from the line charge, [4] then... I would expect...at all points, the e-field would be radiating outward from the line charge (drawing arrows from the line charge). [5]

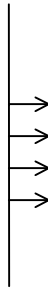

Turtle: So, if I were to use cylindrical coordinates, that would be best. [6]

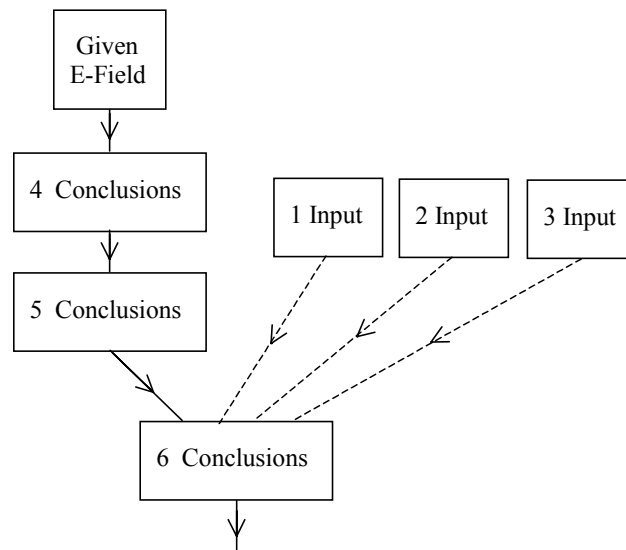

Figure 7.6 - Diagrammatic representation of Turtle's conclusion to use cylindrical coordinates.

In this excerpt, Turtle makes the decision to use cylindrical coordinates in her problem solution. In Statements [1], [2] and [3], Turtle articulates several of the important features of the problem that will affect her decision of what coordinates to use. Turtle then realizes in Statement [4] from the problem statement that the electric field is “radially outward from the line charge.” At first glance, Statement [5] seems to be a reiteration of Statement [4]. However, noting the drawing associated with Statement [5] indicates that a translation from the verbal representation into a pictorial representation has occurred. Finally in Statement [6], she concludes that cylindrical coordinates “would be best.”

An experienced problem solver would likely come to the conclusion to use cylindrical coordinates very quickly, arguing that since the electric field is cylindrically symmetric, cylindrical coordinates will be simplest. This student, however, arrived at this conclusion only after a 30-40 second thinking process. Clearly, making this decision is a much lengthier process for Turtle than for a more experienced problem solver.

This phenomenon was not isolated, but was common throughout the interviews among all students, strong and weak. One of the strongest students in the sample and the student who presented the most complete solution to this problem, Q, also exhibited this behavior.

Q: So my da is $rdrd\phi dz$. [1] No, that is volume. [2] So the dr part is constant, [3] so dz ... where dz is your length [4] (writing $da = rd\phi dz$).[5]

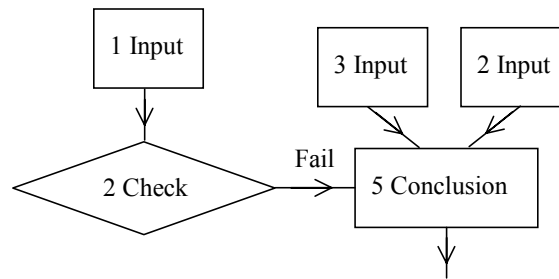

Figure 7.7 - Diagrammatic representation of Q's construction of da .

A number of possible explanations for this behavior exist. It is possible that expert and novice problem solvers alike, utilize these complex thinking structures, but that experts are so practiced that this type of thinking has become essentially automatic. Another possibility is that experts are more willing to make tentative decisions and move on knowing that they can reconsider the decision if the path they have chosen is not fruitful.

In any case, these students clearly labor through problem solving tasks that instructors tend to trivialize. This has serious implications for instructors. In lectures, we tend to move very quickly through material they think will be easy for students. This example shows that it is not always easy to know what material will be difficult for students. Thus, it is very easy for students to fall behind in a lecture. Even for those students who can keep up, the time constraints present in a lecture make it unlikely that they are engaged in the decision-making processes that

characterize their problem solving. When discussing one of the more lecture-oriented courses in the Paradigms, Turtle, herself noted,

Turtle: It made sense watching him draw the conclusions, but it's things I probably would have run across on my own and stopped and thought about, but because of the... when you are just sitting there in lecture it just keeps going.

She also hinted that more student-controlled alternatives to the lecture mode may yield some relief.

Turtle: ...it is nice to be able to work in a group...you come across more problems when you are actually doing it yourself than just watching board work.

7.4.2.3 Moving on with the Aid of Terminating Statements

Throughout the interviews, some of the subjects were observed to end a train of thought abruptly when it appeared to be unfruitful. In many of these instances, the subject had engaged in a prolonged checking process that was not yielding productive results. These abrupt terminations were often signaled by a frustrated statement that indicated the subjects were willing to accept an answer in which they had little confidence so that they could move on. These statements were denoted terminating statements. In order to assess the importance of terminating statements, we searched each of the interviews. Six of the 15 subjects used at least one terminating statement.

Only two of the subjects, Chameleon and Enkidu, used a large number of terminating statements (5 each). Both of these students were in the middle performance group. In these two cases, most of the terminating statements came after the subjects had tried and checked various avenues in an attempt to make progress toward a problem solution. These terminating statements indicate some level of frustration on the part of the subject. In essence, the subjects are saying,

“That is my best guess. I’m spending too much time on this and not getting anywhere. Let’s move on.”

In many of these instances, the subjects had engaged in one or more conclusion-check cycles without making significant progress. Thus for Chameleon and Enkidu, these statements served as a mechanism to escape an unproductive thought cycle. The following excerpt from Enkidu’s interview demonstrates this. Prior to this excerpt, he has developed and checked several other expressions for dx . The terminating statement is underlined.

Enkidu: I'm going off memory now.

$$dx = r \cos \phi d\phi$$

Enkidu: Well, that wouldn't be the x term cause that's just $d\phi$. That doesn't make any sense really

Interviewer: Why doesn't it make sense?

Enkidu: Because... the only thing that's changing here is ϕ . I guess...the only thing that's changing here (indicating the dx equation) is ϕ in the dx . And if x is equal to the...there's two variables and they are throwing me off. Where dx ...there's only one variable...one of the two is changed in that small element. But then again, I'm starting to think about, it helps to say it, the r term is just a scalar in here, determining how far away from the origin you are. So, I think I'm going to go with that.

After this terminating statement, he proceeds to use the value of dx proposed above.

It becomes apparent later in the interview that Enkidu has noted his assumption here as suspect. In the following excerpt, he identifies this as one of the possible sources of difficulties he encountered later.

Enkidu: The two things that are bothering me. The first one is that I wrote dx ... I agree with the dz . That is the same in cylindrical and Cartesian. The $dx = r \cos \phi d\phi$. That, I totally don't like.

In Chameleon's case, his terminating statements were mostly near the end of his problem solution. They tended to indicate frustration and an unwillingness to further justify his reasoning. In a sense, Chameleon's terminating statements signaled that he was giving up.

Chameleon: I'm probably way off, but that's why partial credit is there.

...

Chameleon: Which is some number, so now there is no dependence on r . It's just in the z direction now. Which completely baffles me. And that is the flux. I guess it would be a number because I said it wouldn't have a direction, but who knows. So it equals some number, we know that. So that is as far as I can do here.

Initially we thought that subjects in the low performance group would use a larger number of terminating statements. That is, they would make progress with the aid of many unchecked statements. Upon examination of the data, we found exactly the opposite result. Jerry was the only subject in the low performance group to use even a single terminating statement.

This is not to say that subjects in the low performance group did not make erroneous statements, only that they did not tend to use information that they thought might be incorrect. Typically when these subjects encountered suspect information they became stumped.

In general, the subjects in the low performance group experienced difficulty deciding how to proceed. Where as some students in the middle and high performance groups made terminating statements to allow them to proceed in what they perceived as a fruitful direction, the subjects in the low performance group were typically unable to choose a direction to proceed.

7.4.3 Student Understanding of Flux

The combination of the main interview problem and the follow-up question asking students to explain flux has proved to be a powerful tool for exploring students' understanding of electric flux. Subjects' understanding of electric flux varied greatly throughout the sample. The interviews revealed that most of the students had a reasonably complete model of flux. However, only two of the subjects made the connection between flux and Gauss's Law. In this section, we will describe the models of electric flux used by students in this interview. First, we will describe the features we feel constitute a reasonably complete model of flux.

A simple but useful definition offered by many of the students interviewed is that flux is "the total amount of field through a given area." This basic definition indicates several important properties of the concept of flux. First, it indicates that flux is the summation of the field over a given area. Second, it suggests that the only part of the field that is important is the component that passes through the area. While this simple definition is useful, it is worded loosely enough that students can easily misinterpret it. Thus, a complete model of flux needs to be connected with a quantitative definition. The equation for electric flux, $\Phi = \int \vec{E} \cdot d\vec{a}$, provides this definition.

However, having the verbal and quantitative definitions described above is not enough. In order to use the idea of flux, students need to be able to connect the quantitative and qualitative representations of flux. In particular, students need to understand that taking the dot product between the electric field and the normal vector to the surface of interest gives them the component of the electric field perpendicular to the surface. In addition, students must understand that the component of the electric field perpendicular to the surface is what is meant by the part of the electric field that goes through the area. It is also essential that students understand that the integral in the flux equation corresponds to the summation of

the correct component of the field over the area of interest. Figure 7.8 contains a pictorial representation of the connections between the verbal, symbolic and visual representations of flux.

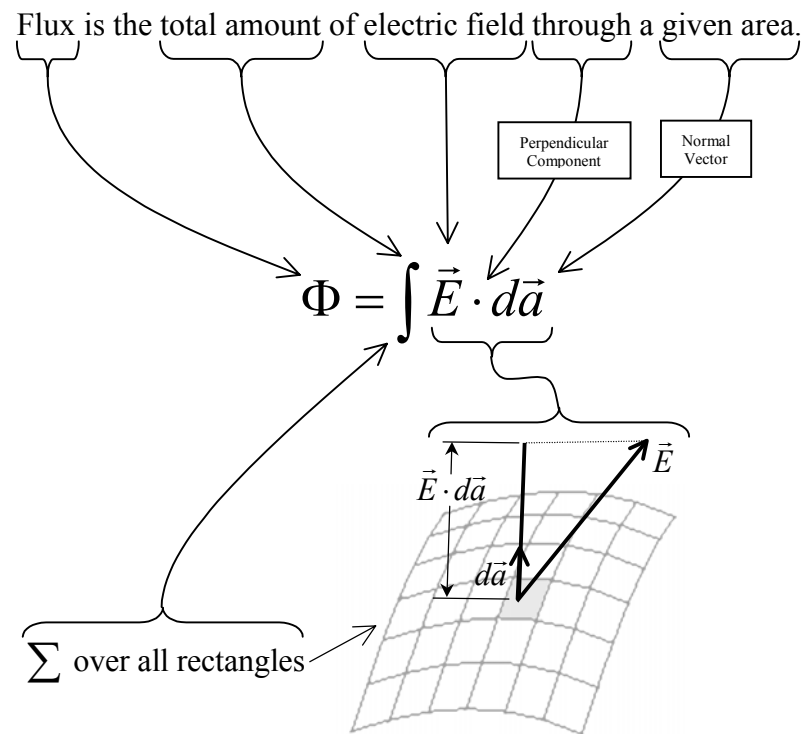

Figure 7.8 - Pictorial representation of connections between the verbal, symbolic and visual representations of flux.

7.4.3.1 *Students' Explanations of Electric Flux*

We obtained information about students' concepts of flux from three sources in the interviews. First, as one of the follow-up questions, we asked each student to explain flux. In addition, many of the students explained flux while they were solving the main problem. Finally, we were able to learn something about

students' understanding of flux based on their solution methods for the main problem and the extension involving a hexagonal tube (see number 2 on page 74). We examined each interview transcript to identify which elements of the above model were present in each student's explanation of flux. In addition to examining students' responses to the follow-up question about flux, we searched the entire transcripts for statements about flux.

A tabulation of the results of this analysis is contained in Table 7.4. For each subject we identified the number of pictorial and symbolic/verbal representations used to explain flux. Any picture drawn or referenced in a subject's explanation of flux was counted as a pictorial representation. Symbolic/verbal representations consisted of equations or verbal definitions the subjects used to describe flux. It was also noted whether the subjects mentioned a concrete representation, e.g., water flow, in their explanation of flux. Whether the student produced all, part or none of the equation for flux during the interview was recorded in the equation column. In the three columns to the right of the equation column is recorded whether the subject mentioned the dot product, the perpendicular component or integration/summation. In each of these columns, *yes* indicates that the item was mentioned in the subjects response to the follow-up question, *cntxt* indicates that the item was mentioned in the context of the problem solution and *no* indicates that the item was not mentioned during the interview. The final column lists a categorization of each student's definition of flux and a paraphrased definition from each interview.

All of the subjects in the medium and high performance groups used a reasonable model for flux. All but one of them explained flux as the **Total Field Through the Surface**. Subjects who defined flux in this way were categorized **TFTS** in the definition column. There was some variation in the definitions provided by subjects in the TFTS category. Some described flux more generally, referring to the "amount of stuff" or the "amount of quantity" that passes through a given area. Penguin defined flux as, "the amount of charge that goes through a surface." Since Penguin used the concept of electric flux correctly in his problem

solution, it is likely that his mention of charge in the definition of electric flux reflects carelessness in his choice of words rather than a fundamental misconception.

Unlike the other subjects in the high and middle performance groups, Bravo explained flux using the flux equation (**Eqn**) as a basis. Bravo noted most of the important elements in his explanation of flux, but used the equation for flux as a foundation for his explanation.

The definitions of flux proffered by each of the subjects in the low performance group revealed that the subject's model of flux was incomplete or significantly flawed. Blue provided the most correct definition in the low performance group, however his definition of flux was given in terms of field **Lines**. He defined flux as, "the amount of field lines that pass through the area." Throughout Blue's interview, he referred only to field, never mentioning field vectors. Scooby's and Garfield's definitions of electric flux were connected to models of rain and fluid flow. Both of these subjects presented a definition with a **Time** component, e.g., "the amount of flow that passes over a given area in a certain amount of time." While this definition is correct in the case of fluid flow, it is incorrect for electric flux. The definition given by Sirius refers to the flux through a volume. In addition, his problem solution indicates that he thinks of flux in terms of the amount of field passing through a three dimensional volume as opposed to a two dimensional area. Sirius's definition was labeled **3D**. Finally, Jerry provided a very loose definition of flux referring to "the varying of the field on...or through a surface." His solution to the main problem indicated that he had no clear model for flux. Because his definition was so loosely constructed, it was labeled **???**.

Name	Pictorial Representations	Symbolic/Verbal Representations	Concrete Representation	Equation	Dot Product	Perpendicular	Integral/Sum	Definition
Jerry	0	1	no	part	no	no	yes	??? - Flux would be the varying of the field on a surface or through a surface.
Sirius	0	1	no	none	no	no	no	3D - It measures how many electric field vectors enter a region vs. how many are pointing out
Scooby	0	1	yes	all	cntxt	no	cntxt	Time - If I'm driving my car and it's raining. If I'm stopped... If I'm moving more rain hits the windshield. TFTS (cntxt) - It's just the amount of field that passes through this surface
Blue	3	1	yes	part	Yes	Yes	Yes	Lines - The flux would be the amount of field lines that pass through the area.
Garfield	1	2	yes	all	cntxt	cntxt	cntxt	Time - Flux is the amount of flow that passes over a given area in a certain amount of time.
Yellow	2	1	no	all	no	no	no	TFTS - Flux is the amount of vector field that goes through the surface. Mentions what is going in and what is going out.
Parsec	0	1	yes	all	cntxt	cntxt	cntxt	TFTS - It's the amount of quantity in question that passes through a surface.
Turtle	0	1	no	all	yes	cntxt	no	TFTS - The amount of electric field through a given area.
Tortuga	1	2	yes	all	yes	yes	yes	TFTS - The amount of field that passes through a surface. You can integrate (the dot product of the vector and the da)...add them up and get the amount passing through the surface.
Chameleon	1	1	no	all	cntxt	no	no	TFTS - The e-field that goes through the surface is the flux.
Enkidu	1	1	no	all	yes	no	yes	TFTS - The total field passing through the given surface.
Bravo	3	1	no	all	yes	yes	yes	Eqn - You write it like this (pointing to flux eq) You use this relation then you perform the dot product and then you integrate over the surface.
Penguin	3	1	no	all	no	yes	no	TFTS - Flux is the amount of charge that goes through a surface normal to the surface. (Confuses charge and field in his definition. Also talks about the amount of "stuff")
Shedder	1	1	no	all	cntxt	cntxt	cntxt	TFTS - Number of field lines coming out of this surface. Tries to resolve confusion between # of field lines and field line density models of flux.
Q	1	2	yes	all	cntxt	cntxt	cntxt	TFTS - It's the amount of something going through an area...a surface area

Table 7.4 - Characterization of students' explanation and use of flux

The following two sections will describe in more detail the subjects' particular models of flux. Students' failure to correctly use Gauss's Law and Field lines will be discussed in Section 7.4.3.2. Then, in Section 7.4.3.3 we will describe some of the incomplete and/or incorrect flux models that students used in these interviews.

7.4.3.2 Gauss's Law and Field Lines

Most of the students in the middle and high performance groups used an essentially correct model of electric flux. In particular, all of these subjects used the Total Field Through the Surface (TFTS) definition and all of them recalled the correct equation for flux. Most of the subjects also mentioned the dot product and/or the component of the electric field perpendicular to the surface.

The one point that was missed by all of the students in the middle performance group, was the connection between the electric flux and Gauss's Law. That is, none of the middle performance students was able to simplify the problem using Gauss's Law. In contrast, both Q and Shedder were able to solve the problem using Gauss's Law. Interestingly, three of the subjects in the middle and low performance groups considered equating the flat side opposite the charge with an arced side in order to simplify the problem. Blue, Turtle and Chameleon each realized that the problem would be simpler if the flat side were instead a side of constant radius, however, none of them was able to justify this simplification.

It is clear in the following excerpt from Blue's interview, that Blue has a rudimentary understanding of the behavior of field lines.

Blue: If I remember right from class he said that ... if we have a cylinder here. (drawing a cylinder) And this would be our triangle thing. (drawing a triangular tube inside the circle with one edge along the axis of the cylinder)

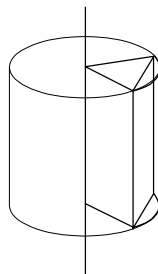

Blue: The flux through that surface would be the same as... this little cylinder on the outside (indicating the piece of the cylinder bounded by the edges of the triangular tube)... because it would have the same amount of field lines going through this outer surface as it does on this inside surface (indicating the side of the triangular tube opposite the charge).

Blue realizes that under some circumstances he can equate the flux through one surface with the flux through another. He mentions that this is possible because the same number of field lines pass through both surfaces. However, the following excerpt illustrates the limitations in his understanding. Blue clearly remembers pieces of something that was mentioned in lecture, but has not yet assimilated this information into his understanding of electric flux.

Blue: All I remember is the diagram he was drawing. Something to the effect if you had some weird surface up here above the x-y plane. (draws axes and irregular surface). Like if this was all curved and odd (indicating the irregular surface) Then, it projected down onto the x-y plane, even though it was an odd shape out here, the same... (drawing a projection down onto a square in the x-y plane)

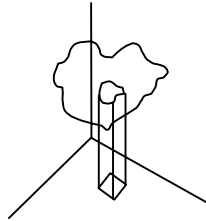

Blue: I guess that doesn't really make sense, does it. Even though this was oddly shaped and curved up here, it would have the same amount of flux as the square... down here. So, what I got out of that was that the flux could be projected into a nice area even if it was an oddly shaped surface on the outside. So I was kind of trying to use that here. ... because, this flat surface would be hard to describe in cylindrical coordinates ... I was trying to apply what Professor Plum said in class and what I kind of remember to this problem.

Blue's understanding of flux is in large part intuitive. While this allows him to make many true statements about the nature of flux and helps him to identify simplifications in the problem, it does not provide him with a means for making quantitative statements. His explanation in this case is based on a picture he remembers from class. Strangely, the picture he remembers lacks any reference to field lines or vectors.

Before she solved the problem using Gauss's Law, Shedder had similar difficulties trying to justify equating the flat side to an arced side.

Shedder: I didn't think, in the beginning... I thought that the field lines would depend upon the radius... because, I didn't think that they would be as dense. But then, the number of field lines coming through would be the same for the angle that was cause, either having this flat surface or the curved surface. It's just. No, I guess that wouldn't. But then you would have more surface area. So, I guess I can't do that.

Interviewer: Explain that again please.

Shedder: The flux is equal to the amount of field coming through the surface. I'm looking... the number of field lines coming out of this surface (indicating the surface opposite the charge in her 3-D drawing) would be equal to the number of field lines coming out of this surface (indicating the cylindrical arch surface bounded by the surface opposite the charge in her 3-D drawing) if I didn't take the radius into account. Being different from here (indicating a radial line along one edge of the triangular tube) than it would be to here (indicating a radial line bisecting the triangular tube) I'd have more surface, but the same amount of field lines.

These two excerpts illustrate the difficulties students had with field lines.

These excerpts illustrate attempts to justify their proposal that the flux through an arced surface subtending the same angle was equal to the flux through the flat surface they were given. In each of these instances, the subjects relied heavily on the concept of field lines to draw these conclusions. In the end however, these field line models failed since they did not yield to quantitative analysis and were not well connected to the students' other models of flux.

While the utility of field lines is certainly limited (Wolf, Van Hook & Weeks, 1996), these interviews indicate that field lines are not entirely useless. In particular, field lines are a simple way to illustrate the basic principles of Gauss's Law and provide a framework for explaining charges as sources and sinks for the electric field. Unfortunately, any extension of the field line model beyond these limited applications is fraught with obstacles. According to Wolf, Van Hook and Weeks, there is no self-consistent, quantitative model of field lines. Moreover, field lines cannot be simply connected to a symbolic representation. That is, the process of drawing an individual field line from the equation for the electric field is quite complex. In contrast, any electric field vector can be drawn simply by

determining the field magnitude and direction from the equation for electric field and drawing the corresponding arrow.

Still, the concept of field lines is presented in most introductory courses and is already in the minds of many of our students. Six of the 15 students in this study mentioned field lines explicitly in either their definition of flux or their problem solution. Another four of the subjects used field lines in one or more of the drawings in their interview. Prior to this study, each of the subjects was engaged in a three-week course on static vector fields. Even though this course utilized the field vector model almost exclusively, two-thirds of the subjects used field lines as part of their solution.

7.4.3.3 *Incomplete and Incorrect Models of Flux*

Subjects in the low performance group utilized a variety of incomplete and incorrect models of flux. Garfield and Scooby both had models of flux based on fluid flow. In each of these interviews, the subjects mention the amount of substance that passes through an area per unit time. The following two excerpts from Garfield's and Scooby's explanations of flux illustrate this.

Garfield: Flux is the amount of flow that passes through a given area over a specific amount of time. Can I use a picture?

Interviewer: Do whatever you need.

Garfield: It's... Say this is like a ring in a pipe. (drawing a ring with arrows through it. It's the amount of water that flows through this in a given amount of time. That's what my understanding of flux is.



Here Scooby tries to use her model of flux to calculate the flux through the surfaces of the triangular tube. When she is faced with a difficulty, she refers to a description of flux presented to her by a graduate teaching assistant, Shaggy.

Scooby: To get the flux through, you need to know how much of the electric field is going through here (motioning upward)... going through...

Scooby: If it's going in the \hat{r} direction, out this way (indicating away from the string in the model) It's moving in this direction. It's not going up at all. There is no flux...no electric field going up, so I can't integrate... That's not what I'm concerned about. I need the flux this way, because that's the way it's moving. Because the flux... the best analogy I got was from Shaggy (a GTA) when he said that flux is like when you are driving your car and it is raining. When you speed up, more rain hits your car window. When you are stopped it is not going through there as much. So if I'm going this ... if it's going in the \hat{r} direction, this is the way, I want to go for the flux. Right?

This example demonstrates the lack of coherence in Scooby's model of flux. As she solves the problem, Scooby utilizes a model of flux that is by all accounts similar to the TFTS (Total Flux Through the Surface) model used by most of the students in the middle and high performance categories. However, when she is stumped she reverts to this rain model and its associated flow analogy.

Scooby: Flux is the amount of stuff that passes through a surface per unit of time. Right?

Interestingly, near the end of her interview, Scooby is able to reason her way out of this time-flow representation of flux.

Scooby: But I don't have a unit of time. I don't have a unit of time obviously. It's just the amount of the electric field that passes through this surface.

Sirius's explanation of flux also showed serious inconsistencies in his model of flux. In his explanation, he uses field lines and field vectors interchangeably.

Sirius: (Flux) is the measure of how much... how many electric field vectors enter a region compared to how many are pointing out of it...

Interviewer: You said how many vectors. You said how many electric field vectors. What determines...How do you find out how many electric field vectors?

Sirius: You draw consistent umm... You draw field lines in a way that is consistent so that ... Since the electric field is stronger down on the line, the electric field vectors would be larger down there (drawing a large arrow from the charge upward) than up here (drawing a smaller arrow farther from the charge)

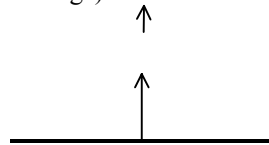

This confusion between field lines and field vectors is prevalent throughout Sirius's problem solution as well as in his explanation of flux. In addition to these difficulties, Sirius also does not carefully define the region over which flux is calculated. Throughout the interview, he discusses flux through both a surface and a volume. His difficulties may result from confusing the flux through a closed surface (Gauss's Law) and the flux through a single surface.

Finally, Jerry presented the most pathological description of flux seen in any of the interviews.

Jerry: Without contemplating it for a half an hour I would say that flux would be described as the varying of a... In this case it would be the varying of the field within a certain place like a surface...within a certain area. The flux would be the difference between them, the variance.

Interviewer: Explain that again?

Jerry: As you can tell I don't explain this very often. Say you have a surface and you have a field going through it. Flux would be the varying of that field through that surface or on that surface. The different varyings of it.

Strangely, Jerry was able to make elaborate calculations of the flux through the triangular tube. Jerry was the only student in the sample to present a solution that involved flux through all three sides of the triangular tube. The randomness of his

solution in conjunction with this definition of flux suggests that Jerry did not think much about flux before this interview.

While each of these incomplete models was only utilized by one or two student in the sample, they illustrate some of the misconceptions and confusions that students encounter with the concept of flux.

Chapter 8 Discussion

In this chapter, we tie together the results from the three studies presented in this thesis. We discuss the results and conclusions dealing with visualization and construction in problem solving. Then, we summarize our findings with regard to junior physics majors models of flux and concepts of electric field. We also address the relevant findings regarding the transition defined in Section 3.3. Finally, we provide a summary of the hypotheses and recommendations that have resulted from the studies presented in this document.

8.1 The Role of Visualization in Problem Solving

In Chapters 6 and 7 we saw that visualization played a part in every student's problem solving. At first glance, this seems to contrast the results of Chapter 4, which suggest that performance in physics classes is independent of spatial ability as measured by the Purdue Spatial Visualization Test. However, a more careful examination of these results tells a different story. First, the average PSVT scores of the subjects interviewed was very high, greater than 31 out of 36 for both the preliminary and final interview samples. In addition, the spread in these scores was very low. This suggests that the spatial abilities of the students in this study are quite high, and that the spread in their spatial abilities is quite low. In this light, the results of Chapter 4 really tell us that the spread in spatial ability among the students in that study did not account for very much of the spread in their grades. This is not surprising considering that the spread in spatial ability was so small.

Hypothesis 1: The three dimensional spatial ability of junior physics majors is very high and the variation in spatial ability is small.

Data from the interviews in Chapters 6 and 7 clearly show that visualization is an integral part of students problem solving. It is also clear that students' use of visualization in problem solving is deeply connected to the non-visual aspects of their problem solving. It appears that images are often a central part of students understanding. Two-thirds of the students in the final interview sample used one or more pictures in their explanation of flux. All of the subjects interviewed used images in their problem solutions, but many of them experienced difficulty doing so.

Teachers often assume students know how to use the visual representations presented in lecture and in the text. The data presented here suggest that this assumption is invalid. In particular, we have seen that students often have difficulty constructing/recalling information that we consider trivial. We have also seen that students have difficulty incorporating visual representations associated with Gauss's Law and field lines into their model of flux. Several of the students exhibited difficulty understanding the limitations of the field line representation, while others were unable to muster the simplest Gauss's Law arguments to simplify their problem solution. Clearly, more research needs to be done in order to improve our understanding of how students incorporate visual representations into their models of physical systems.

In Section 7.4.2.1 we saw two excerpts in which students used extended thinking processes to achieve what experienced physicists might consider trivial conclusions. In each case the student experienced difficulty translating between visual and symbolic representations. While based on only two instances, it is reasonable to conjecture that student difficulty in translating between visual and symbolic representations is responsible for a significant part of the problems students encountered during the interviews described in Chapter 7.

Hypothesis 2: Many junior physics majors have difficulty translating between visual and mathematical representations associated with complex physical phenomena. In particular, they struggle to draw explicit

connections between standard visual representations and equations in electrostatics.

It would be interesting to test this hypothesis in a future study. It would also be worthwhile to explore how this varies with subjects' problem solving experience. This could be achieved by comparing junior physics majors' ability to translate between visual and symbolic representations with that of professional physicists. However, we could obtain more relevant data by conducting a longitudinal study in which we track students as they progress from novice to expert problem solvers.

In addition to these translation studies, we would like to explore the particular representations that students use in more detail. The present study is limited because we did not ask students specific questions about their visualization, but instead gave them the freedom to tell us what they chose with minimal direct questioning. Consequently, we only have access to the information that students thought was valuable or that they thought the interviewer would be interested in. More directed questions about what visual representations the subjects were using would likely provide more information about the particular visual representations they have in their minds. We envision conducting interviews similar to those described in Chapters 6 and 7, but directly probing students about the visual representations they use; asking them if they have any pictures in their minds as they are working through the problem and asking them to describe these mental pictures. Conducting study with the interview question used in Chapter 7 would allow us to use the current study as a check to see if the more direct questioning had a significant impact on students' problem solving behaviors.

One method for combating the difficulties students experience translating between representation is to engage them in activities in which they explicitly draw connections between various representations. For example, a simple activity might involve presenting the three representations of flux shown in Figure 8.1. One could then break the students into small groups and ask each group to identify

the connections between a pair of these representations. The groups would then draw an arrow representing each connection. Finally, students would present and explain the connections they identified in a class discussion.

1. Flux is the total amount of electric field through a given area.

2.
$$\Phi = \int \vec{E} \cdot d\vec{a}$$

- 3.

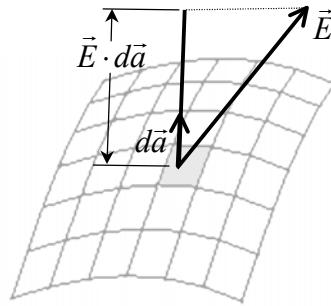

Figure 8.1 - Three representations of electric flux.

8.2 Construction in Problem Solving

In Section 7.4.2 we describe our observations of the construction-checking behavior exhibited in these interviews. We found that a common method for acquiring needed information while problem solving was to use several pieces of known information to construct another piece. This process took many forms from building an equation out of known properties to construction of differential area elements from a recalled picture. Students in the high and middle performance groups used this technique with some effectiveness. Subjects in the low

performance group tended to make more incorrect statements. In addition, these subjects made fewer checking and construction statements.

Hypothesis 3: When dealing with complex physical concepts, junior physics majors often employ a process of construction to recall/reconstruct important details of the relevant physical models.

The observations made in this study were, however, only formative. A more complete study exploring students' ability and tendency to draw conclusions and check these conclusions would provide a clearer picture of how these abilities varied over our population. It would be particularly interesting to examine the differences between expert and novice problem solvers in this respect.

The checking-construction process was also seen to have several variations. In Section 7.4.2.1 we saw that in some instances, students constructed quantitative conclusions from qualitative properties, while in others they recalled equations from which they then extracted qualitative properties. Studying the extent to which each of these strategies is used by experts and novices may provide some useful insight into the differences between them.

We saw in Section 7.4.2.2 that some tasks we might view as simple recall require more labored thinking for our students. In particular, the examples presented there illustrate that in some instances students go through a laborious process to construct seemingly trivial pieces of information from even simpler elements. This behavior is reminiscent of the behavior of novice problem solvers observed by Larkin (1979). In that study, it was found that the novice problem solver verbalized her thinking process almost continuously while the expert mentioned only the results of calculations. The authors argued that the novice had to reason through every step of the problem solution while the expert could perform certain procedures automatically. Still, the fact that subjects in this study sometimes used construction to rebuild nontrivial images and equations indicates

that these students have developed knowledge structures that are more advanced and connected than the simple fact lists common to novice physics students.

Hypothesis 4: Explicit construction activities, like those described above, are an essential part of students' development from novice to expert problem solvers.

This strikingly common construction process is undoubtedly more time consuming and more mentally taxing. This result has significant implications with respect to the lecture format of most upper-division classes. In particular, since most lecture based classes move quickly through material, it is often difficult for students to process lecture information in a productive way. Turtle summed it up in her interview when she noted of a lecture class that, "It made sense watching him draw the conclusions, but it's things I probably would have run across on my own and stopped and thought about," however, "in lecture it just keeps going." Turtle's comment suggests that students recognize the advantages of being able to think through the material rather than struggling to keep up. One possible solution to this problem is to increase the degree of student control in the classroom. A common method for achieving this is with student-centered activities like small group activities or integrated labs.

Unfortunately, time constraints make it impractical to cover all course materials in student-centered activities. However, it may be worthwhile to use this type of activity to improve students' understanding of key concepts. The results described above suggest that students may have particular difficulty constructing conclusions and drawing connections in the fast paced environment of the lecture. Therefore, it may be particularly effective to use these activities when students are supposed to draw connections or learn the reasoning behind conclusions.

One could study the effectiveness of such an activity by observing students as they participated in the activity and conducting brief interviews to determine the extent to which subjects incorporated these connections into their model for flux.

8.3 Students' Models of Electric Flux

In Section 7.4.3, we described our observations of students' understanding of flux in the final interviews. We found that all of the students in the high and middle performance groups had an essentially complete model of flux. Still, only two students were able to successfully simplify the problem using Gauss's Law. This suggests that the ideas associated with Gauss's Law are not thoroughly incorporated into students' models of flux.

Hypothesis 5: Many junior physics majors do not spontaneously connect the ideas of flux and Gauss's Law when solving problems.

Since the primary use of electric flux in an electrostatics course is in the application of Gauss's Law, it is essential that students make this connection. It may be useful to explicitly emphasize the connection between Gauss's Law and flux. Focusing on the role of Gauss's Law as a simplification technique in problem solving may encourage students to utilize Gauss's Law beyond the solutions to standard problems (i.e., finding the electric field outside of highly symmetric shapes). A particularly effective strategy might be to give students the opportunity to work through a problem similar to the one used in the Chapter 7 interviews with the aid of an instructor. By directing students to make explicit simplification arguments, like those outlined in Solution 1 of the Appendix, an instructor can force students to reason through simplification arguments based on Gauss's Law.

We found, in Section 7.4.3.3, that all students in the low performance group had either incorrect models of flux or serious deficiencies in their models. A full one-third of the subjects interviewed fell in to this category. Therefore, teachers should not be surprised to find that some of their students have erroneous models of flux. Among the five people who had erroneous flux models, we identified four distinct misconceptions. It would not be feasible for an instructor to try to address each of these misconceptions in class. However, by being aware that these are still

common at the upper-division, instructors may be able to identify these pathologies and address them one-on-one in office hours.

8.4 What to do About Field Lines

In Section 7.4.3.2 we draw a connection between students' use of field lines and their difficulties applying Gauss's Law to flux problem. In particular, we found that while the students were recently engaged in a course that used the electric field vector representation almost exclusively, most of them persisted in using electric field lines to some extent in their solutions. We found that several of the students used electric field vectors and electric field lines interchangeably and that others clearly confused the two concepts. Data from our interviews suggest that students do not clearly delineate between the electric field vector and the electric field line models.

Hypothesis 6: Many junior physics majors do not properly distinguish between the field vector and field line representations of electric field.

The difficulties associated with electric field lines have been addressed in the literature (Herrmann, Hauptmann, & Suleder, 2000; Törnkvist, Pettersson, & Tranströmer, 1993; Wolf, Van Hook, & Weeks, 1996); however, teachers continue to use this formalism. We argue in Section 7.4.3.2 that field lines have no simple quantitative representation. We do not argue, however, that they have no value. On the contrary, field lines can be a particularly useful part of our model since they emphasize the role of sources in the concept of electric field. Field lines are particularly useful when making qualitative arguments about the flux through a region. The common pictures (See Figure 8.2) used in the formulation of the integral formulation of Gauss' Law are very powerful. Several students included these pictures in their explanation of flux.

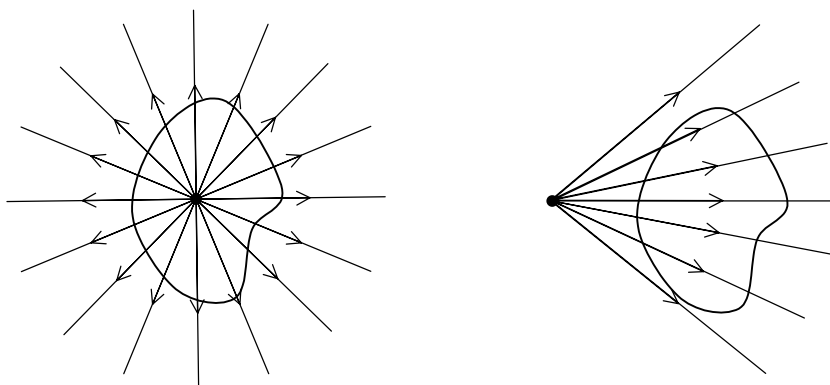

Figure 8.2 - Field line diagrams commonly used in the introduction of the integral formulation of Gauss's Law.

Whether or not we think they are useful, field lines are part of students' understanding of electric field. These electric field line diagrams seem to be very robust. That is, some students remember these images long after they have forgotten the equations for flux and Gauss's Law. Thus, the question is not how to eradicate field line diagrams from our students' minds, but how to incorporate the concept of field lines appropriately into students' models of electric field.

We propose that this might be achieved by having students observe the properties of field vectors and field lines simultaneously. We feel that it is important to include both field vectors and field lines in an upper-division introduction to electrostatics, since students have already seen the field line model in the lower division. If we introduce field vectors as if they are the only representation then it is easy for students to confuse the new model of field vectors with their previous model of field lines. We believe that it will also be important to directly contrast the differences between the two models and to emphasize the fact that these are only models of electric field and that each have certain advantages and disadvantages.

A simple activity that would allow students to identify some of these advantages and disadvantages would be to divide the class into groups. Give each group a simple charge distribution, for example three pairs of charges, one with two

equal positive charges, one with two equal negative charges and one with equal but opposite charges. Each group would be given a piece of graph paper on which they would draw their charge distribution and the resulting electric field. Half of the class would be assigned to draw representative field vectors, while the other half of the class would draw representative field lines. Prior to the activity, subjects would be given procedures for constructing both field vectors and field lines. After the students have completed their representations of the electric field, they would be asked to use their diagrams to estimate the magnitude and direction of the electric field at several points chosen by the instructor. Finally, students would calculate the magnitude and direction of the field at these points and compare to their estimates. Students would then present their results to the class. Several important issues are addressed by this type of activity. First, students learn that the methods for constructing field lines and field vectors are very different. Second, when they make their estimates of the field based on their diagrams, students using field line diagrams will find that it is very difficult to make a quantitative estimate of the magnitude of the electric field with field line diagrams. Finally, in the class discussion students will participate in a direct comparison of the field line and field vector models.

It would be very interesting to test this or a similar exercise in class to see if it significantly affected students understanding of the relationship between field lines and field vectors. In particular, it would be valuable to identify exercises that would help students recognize the superiority of the field vector model while still indicating the value of field line diagrams.

8.5 The Transition from Novice to Professional

We mentioned in Chapter 1 that visual/qualitative problem solving strategies are an important ingredient in students' transition from novice to professional physicist. The models we developed in Chapters 6 and 7 will serve as a framework

for examining problem solving in this transition. However, before we can begin to examine this transition, we, first, need to develop a clear description of the problem solving characteristics of incoming junior physics majors.

In Section 2.5 we outline several characteristics identified in the literature that differentiate between the problem-solving behaviors of experts and novices. An important step in describing the problem solving of incoming juniors will be to compare their problem solving characteristics to the characteristics of novices and experts described in the literature. A rough characterization of student problem solving behaviors from the interviews described in Chapters 6 and 7 suggests that the subjects use a variety of problem solving techniques, some of which correspond to novice problem solving behaviors and some of which correspond to expert problem solving behaviors.

Hypothesis 7: Junior physics majors' use some combination of novice and expert problem solving techniques as opposed to a unique set of transitional problem solving techniques.

In order to realize a good characterization, however, we would need to conduct another study involving both junior physics majors and expert physicists. Each group would be interviewed as they solved several problems. Ideally, the problems used would be similar in complexity to those used in this study. In addition, the ideal study would involve a sample at least the size of the one used here. However, realizing this study would require a huge time commitment on the parts of both the researchers and the subjects. A more realistic study would involve fewer subjects and shorter problems. The transcripts obtained from the juniors would be compared to those of the experts as well as to the existing literature, to characterize the extent to which they resemble experts and novices.

This type of study will allow us to answer a variety of questions about our students' problem-solving characteristics. We will be able to draw comparisons between the problem solving behaviors of our students and those of professional

physicists. In addition, we will be able to address questions about their use of visualization in problem solving.

The answers to these questions will help us to better understand the ways that incoming students make the transition from novice to expert physicists. Ultimately, however, the most effective strategy for understanding this transition will require a longitudinal study investigating how individual students change over the course of their junior and senior year.

8.6 Closing

Looking back on my experience as an undergraduate physics student, I realize that the way I thought about physics and indeed the world, changed fundamentally between my introductory courses and graduation. Initially, I only thought about physics in class and while I worked on homework. Like many students, I tried to finish my homework in the quickest way possible. By the time I graduated with my physics degree, I saw physics everywhere. To this day, I still wonder how my perspective changed so dramatically. In many ways, the study contained here was motivated by my own desire to understand how one could develop such a drastically different view of the world in only a few short years

As a teaching assistant in the Paradigms in Physics program I saw other students go through a similar metamorphosis. Corrine Manogue, my thesis advisor, gave this period of rapid change a name, *the junior year transition*. The longer I worked with students in the Paradigms, the more I became interested in exploring how students make this transition. Developing a complete understanding of this transition was clearly too big a task for a single Ph.D. thesis, so I focused my efforts on understanding how students used visualization in problem solving. Over the course of the three studies that make up this thesis, it became clear that students' use of visualization was not isolated, but instead was interwoven with other aspects of their problem solving behavior.

Two key features of this mixing between visual and non-visual in students' problem solving have emerged from the studies presented here. First, the fact that students engaged in construction/checking procedures to recall information suggests that they are building sophisticated knowledge structures rather than relying simply on fact recall. What is really interesting is that these construction procedures involve a mixture of visual, symbolic, and verbal representations. The second instance in which students' mixed visual and non-visual elements occurred when they translate between representations. Translation between images and equations was already an integral part of the problem solving method for many of the students interviewed. While they did not always translate successfully, they did attempt to make connections between visual and symbolic representation of the problem. These two observations illustrate the natural tendency of students to draw connections between various representations while learning.

Even though many of the students interviewed were not able to solve the problem presented to them, they drew together a variety of models and representations in their attempt. It is, in fact, these failed attempts that indicate a transition is occurring. Casual observation of professional physicists reveals that their understanding of a physical system stems from their facility with and ability to connect multiple representations of the system. This is not necessarily the case with introductory physics students. I can remember a time when I wanted to know the one right way of thinking about things. It was only later that I recognized the power of exploring a single physical system in a variety of representations. It is not uncommon for introductory students to want to learn only a single method for solving problems in physics. In contrast to this, students in nearly every interview in this study made an attempt to solve their problem utilizing a combination of representations for the electric field. This clearly suggests that their problem solving strategies have evolved beyond that of the average introductory student.

When do students begin to see the importance of multiple representations in understanding? How does this change in perception affect other aspects of the transition from novice to professional physicist? What can teachers do to

encourage students to utilize and connect multiple representations in physics?

These questions will lead my research as I go on to explore the ways that students change over the course of the upper division physics major.

REFERENCES

- Adeyemo, S. A. (1994). Individual difference in thinking and problem solving. *Personality and Individual Difference, 17(1)*, 117-124.
- Antonietti, A. (1999). Can students predict when imagery will allow them to discover the problem solution? *European Journal of Cognitive Psychology, 11(3)*, 407-428.
- Blade, M., & Watson, W.S. (1955). Increase in spatial visualization test scores during engineering study. *Psychological Monographs, 69(12, Whole No. 397)*.
- Borich, G., & Bauman, P. (1972). Convergent and discriminant validation of the French and Guilford-Zimmerman Spatial Orientation and Spatial Visualization factors. *Educational and Psychological Measurement, 32*, 1029-1033.
- Burnett, S., Lane, D., & Dratt, L. (1979). Spatial visualization and sex differences in quantitative ability. *Intelligence, 3*, 345-354.
- Burnett, S., & Lane, D. (1980). Effects of academic instruction on spatial visualization. *Intelligence, 4*, 233-242.
- Cataloglu, E. & Robinett, R. W. (2001). Testing the development of student conceptual and visualization understanding in quantum mechanics through the undergraduate career. [.pdf file] Available: http://www.phys.psu.edu/faculty/RobinettR/QM/QMVI/QMVI_analysis.pdf
- Chi, M. T. H, Glaser, R., & Rees, E. (1982). Expertise in problem solving. In R. J. Sternberg (Ed.), Advances in the psychology of human intelligence, (Vol. 1). Hillsdale, NJ: Erlbaum.
- Cohen, J. & Cohen, P. (1975). Applied multiple regression/correlation analysis for the behavioral science. Hillsdale, NJ: Erlbaum.
- Ekstrom, R.B., French, J. W., & Harman, H. H. (1976). Manual for kit of factor referenced cognitive tests. Princeton, NJ: Educational Testing Service.
- Forman, A. E. & McPhail, J. (1993). Vygotskian Perspective on Children's Collaborative Problem-Solving Activities. In E. A. Forman, M. Norris & C. Addison Stone. Contexts for Learning (pp. 213-229). New York, NY: Oxford University Press.

- Fuller, R. G., Karplus, R. & Lawson, A. E. (1977). Can physics develop reasoning? *Physics Today*, February, (23-28).
- Gleick, J. (1992). Genius: The life and science of Richard Feynman. New York: Pantheon Books, 241-225.
- Greca, I. M., & Moreira, M. A. (1997). The kinds of mental representations - models, propositions and images - used by college physics students regarding the concept of field. *International Journal of Science Education*, 19(6), 711-724.
- Guay, R. (1976). Purdue spatial visualization test. Purdue, IN: Purdue Research Foundation. (ETS Test Collection No. TC009199)
- Guay, R. (1980, April). *Spatial ability measurements: A critique and an alternative*. Paper presented at the annual meeting of the American Educational Research Association, Boston, MA.
- Herrmann, F., Hauptmann, H. & Suleder, M. (2000) Representations of electric and magnetic fields. *American Journal of Physics*, 68 (2), 171-174.
- Hestenes, D., Wells, M., & Swackhammer, G. (1992). Force concepts inventory. *Physics Teacher*, 30, 141-158.
- Hestenes, D., & Wells, M. (1992). A mechanics baseline test. *Physics Teacher*, 30, 159-166.
- Hortin, J. A., Ohlsen, R. L., & Newhouse, B. S. (1985). Research for teachers on visual thinking to solve verbal problems. *Journal of Educational Technology Systems*, 13(4), 299-303.
- Ivie, R., & Stowe, K. (2000). Women in Physics, 2000. AIP publication number R430. [WWW page] Available: <http://www.aip.org/statistics/trends/reports/wominphys.pdf>
- Inhelder, B. & Piaget, J. (1958). The growth of logical thinking from childhood to adolescence. New York, NY: Basic Books.
- Jolly, P., Zollman, D., Dimitrova, A. & Rebello, S. (1998). Visualizing motion in potential wells. *American Journal of Physics*, 66 (1), 57-63.
- Kovac, R. (1989). The validation of selected spatial ability tests via correlational assessment and analysis of user-processing strategy. *Educational Research Quarterly*, 13(2), 26-34.

- Larkin, J. H., & Reif, F. (1979). Understanding and Teaching Problem-Solving in Physics. *European Journal of Science Education*, 1(2), 191-203.
- Larkin, J., McDermott, J., Simon, D. P., & Simon, H. A. (1980). Expert and Novice Performance in Solving Physics Problems. *Science*, 208, 1335-1342.
- Larkin, J. (1981). Cognition of Learning Physics. *American Journal of Physics*, 49(6), 534-541.
- Lean, G., & Clements, M. A. (1981). Spatial ability, visual imagery and mathematical performance. *Educational Studies in Mathematics*, 12, 267-299.
- Litowitz, B. E., (1993). Deconstruction in the Zone of Proximal Development. In E. A. Forman, M. Norris & C. Addison Stone. Contexts for Learning (pp. 184-196). New York, NY: Oxford University Press.
- Manogue, C.A., Siemens, P. J., Tate, J., Browne, K., Niess, M. L. & Wolfer, A. J. (2001). Paradigms in physics: A new upper-division curriculum. *American Journal of Physics*, 69(9), 978-990.
- McDermott, L. C., & Redish, E. F. (1999). Resource letter: PER-1: Physics education research. *American Journal of Physics*, 67(9), 755-767.
- McMillan, C., & Swadener, M. (1991). Novice use of qualitative versus quantitative problem solving in electrostatics. *Journal of Research in Science Teaching*, 28(8), 661-670.
- Moses, B. (April, 1980). *The relationship between visual thinking tasks and problem-solving performance*. Paper presented at the Annual Meeting of the American Educational Research Association, Boston, MA.
- Mundy, J. (1987). Spatial training for calculus students: Sex differences in achievement and in visualization ability. *Journal for Research in Mathematics Education*, 18(2), 126-140.
- Presmeg, N. (1986). Visualization in high school mathematics. *For the Learning of Mathematics*, 6(3), 42-46.
- Presmeg, N. (1992). Prototypes, metaphors, metonymies and imaginative rationality in high school mathematics. *Educational Studies in Mathematics*, 23, 595-610.
- Pribyl, J., & Bodner, G. (April, 1985). *The role of spatial ability and achievement in organic chemistry*. Paper presented at the annual meeting of the National Association for Research in Science Teaching, French Lick Springs, IN.

- Redish, E. F., Steinberg, R. N., & Wittmann, M. C. (2001). A new model course in applied quantum physics. [WWW page] Available: <http://www.physics.umd.edu/perg/qm/qmcourse/welcome.htm>
- Siemankowski, F., & MacKnight, F. (1971). Spatial cognition: Success prognostication in college science courses. *Journal of College Science Teaching* 1, 56-59.
- Singh, C. (2001). Student understanding of quantum mechanics. *American Journal of Physics*, 69 (8), 885-895.
- Small, M., & Morton M. (1983). Spatial visualization training improves performance in organic chemistry. *Journal of College Science Teaching*, 13(1), 41-43.
- Stericker, A., & LeVesconte, S. (April, 1981). *Effects of Brief Training on Sex-Related Differences in Spatial Visualization*. Paper presented at the annual meeting of the Midwestern Psychological Association, Detroit, MI.
- Törnkvist, S., Pettersson, K. A., & Tranströmer, G. (1993). Confusion by representation: On student's comprehension of the electric field concept. *American Journal of Physics*, 61 (4), 335-338.
- Van Heuvelen, A. (1991). Learning to think like a physicist: A review of research-based instructional strategies. *American Journal of Physics*, 59 (10), 891-907.
- Van Heuvelen, A., & Zou, X. (1999). Multiple representations of work-energy processes. *American Journal of Physics*, 69 (2), 184-194.
- Wertsch, J. V., (1985). Vygotsky and the Social Formation of Mind (pp. 58-76), Cambridge, MA: Harvard University Press.
- Wolf, A., Van Hook, S. J., & Weeks, E. R. (1996) Electric field line diagrams don't work. *American Journal of Physics*, 64 (6), 714-724.
- Zazkis, R., Dubinsky, E., & Dautermann, J. (1996). Coordinating visual and analytic strategies: A study of students' understanding of the group D_4 . *Journal for Research in Mathematics Education*, 27(4), 435-457.

Appendix Problem Solutions

The Problem

An infinitely long line charge generates an electric field $\vec{E} = \frac{\lambda}{2\pi\epsilon_0} \frac{1}{r} \hat{r}$ where λ is the uniform linear charge density and r is the distance from the line charge. The orange thread along the edge of the model represents this infinitely long line charge. Find the flux of electric field through the entire surface represented by the model.

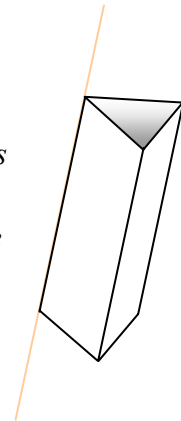

Solution 1

The electric flux can be written

$$\Phi = \int_s \vec{E} \cdot d\vec{a} \quad (\text{A.1})$$

Where the integral is taken over the surface of interest, \vec{E} is the electric field and $d\vec{a}$ is the differential area element associated with the surface over which the integral is taken.

In this case, the surface we are integrating over is the triangular surface defined by the paper model. We can break this surface up into three sides as shown, find the flux through each side independently and add the individual fluxes together to find the total flux.

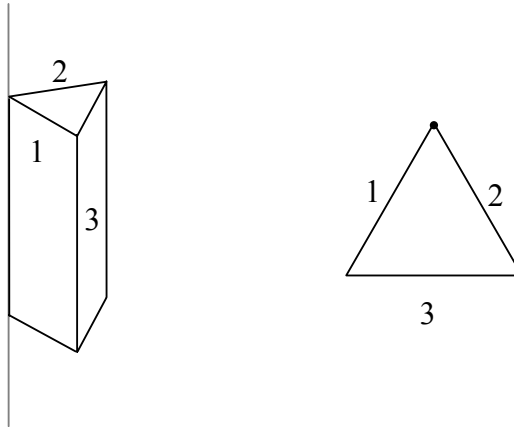

Since the electric field \vec{E} and the differential area element $d\vec{a}$ are perpendicular, the quantity $\vec{E} \cdot d\vec{a}$ is zero and the flux through the sides of the surface adjacent to the line of electric charge (sides 1 and 2) is zero.

Thus, the problem reduces to finding the flux through the side opposite the charge (Surface 3). Using Gauss's Law, we can show that the flux through Surface 3 is equivalent to the flux through an arced surface sharing two edges with surface 3. This surface is shown below.

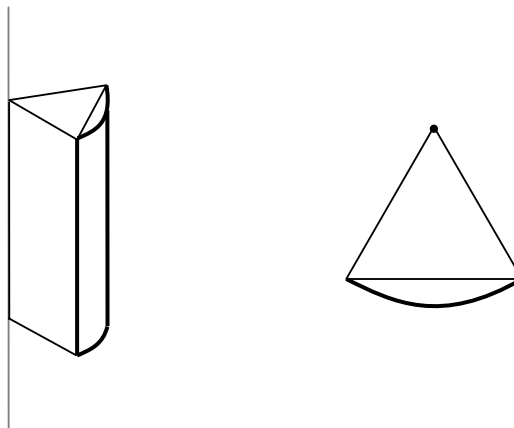

To show that the flux through the arced surface and surface 3 are equal, we will define a Gaussian surface by these two surfaces and flat end caps. As shown below.

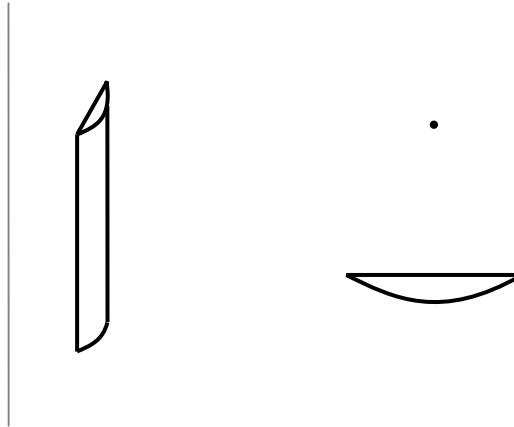

Thus the total flux through this Gaussian (closed) surface is

$$\Phi_{total} = \Phi_3 + \Phi_{arc} + \Phi_{endcaps} \quad (\text{A.2})$$

But the total flux is zero from Gauss's Law since no charge is enclosed in the Gaussian surface. Since the field points only in the radial direction, the field is parallel to the end caps and the flux through the end caps ($\Phi_{endcaps}$) is zero. Thus, the magnitude of the flux through surface 3 and the flux through the arced surface are equal

$$\begin{aligned} \Phi_{total} &= 0 = \Phi_3 + \Phi_{arc} \\ \Phi_{arc} &= -\Phi_3 \end{aligned} \quad (\text{A.3})$$

$$\boxed{|\Phi_{arc}| = |\Phi_3|}$$

Note: The flux of surface 3 and the arced surface differ by a minus sign because the flux of electric field is into the Gaussian surface for surface 3 and out of the Gaussian surface for the arced surface.

The flux through the arced surface can be found by simple integration in spherical coordinates.

$$\Phi = \int_{arc} \vec{E} \cdot d\vec{a} = \int_0^{\frac{L}{3}} \int_0^{\frac{\pi}{3}} \vec{E} \cdot r d\phi dz \hat{r} \quad (\text{A.4})$$

Where L is the length of the triangular tube (and thus the length of the arced surface) and the ϕ variable is integrated from zero to $\frac{\pi}{3}$ because the arc subtends an angle of 60° . In this case, we have substituted the differential area element for the arced surface ($d\vec{a} = r d\phi dz \hat{r}$) into the integral. Next, we substitute the given value of the electric field, simplify and evaluate the integral.

$$\begin{aligned} \Phi &= \int_0^{\frac{L}{3}} \int_0^{\frac{\pi}{3}} \frac{\lambda}{2\pi\epsilon_0} \frac{1}{r} \hat{r} \cdot r d\phi dz \hat{r} \\ &= \int_0^{\frac{L}{3}} \int_0^{\frac{\pi}{3}} \frac{\lambda}{2\pi\epsilon_0} \frac{1}{r} r d\phi dz \\ &= \frac{\lambda}{2\pi\epsilon_0} \int_0^{\frac{L}{3}} \int_0^{\frac{\pi}{3}} d\phi dz \\ &= \frac{\lambda}{2\pi\epsilon_0} \frac{\pi}{3} \int_0^L dz \end{aligned} \quad (\text{A.5})$$

$$\boxed{\Phi = \frac{\lambda L}{6\epsilon_0}}$$

Solution 2

A simpler alternative to Solution 1 is to simply argue that the surface defined in the problem subtends one sixth of a cylinder as shown below.

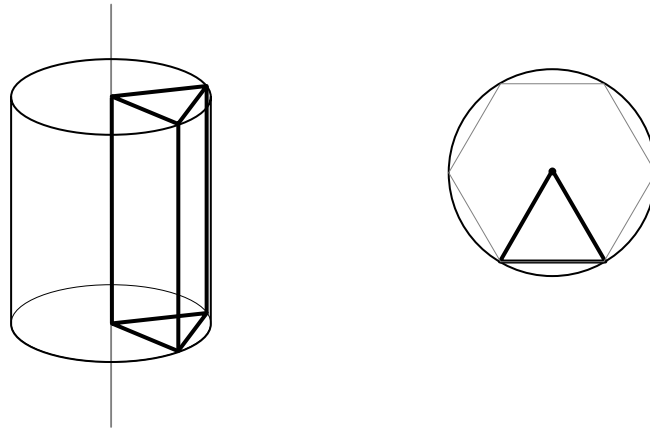

The flux through the surface defined in the problem is then one sixth of the total flux through the cylinder. It is then possible to calculate the flux through the cylinder with Gauss Law.

$$\Phi_S = \oint_S \vec{E} \cdot d\vec{a} = \frac{Q_{enc}}{\epsilon_0} \quad (\text{A.6})$$

The charge enclosed in the cylinder is just λ times the length of the cylinder (L). Since the electric field is parallel to the end caps, no flux passes through them and the total flux through the triangular surface defined in the problem statement is

$$\Phi_\Delta = \frac{\Phi_S}{6} = \frac{1}{6} \frac{\lambda L}{\epsilon_0} \quad (\text{A.7})$$

$$\boxed{\Phi_\Delta = \frac{\lambda L}{6\epsilon_0}}$$